

Vigor3912 Series Security VPN Router

User's Guide

Version: 1.0

Firmware Version: V4.3.5.1

(For future update, please visit DrayTek web site)

Date: January 24, 2024

Copyrights

© All rights reserved. This publication contains information that is protected by copyright. No part may be reproduced, transmitted, transcribed, stored in a retrieval system, or translated into any language without written permission from the copyright holders.

Trademarks

The following trademarks are used in this document:

- Microsoft is a registered trademark of Microsoft Corp.
- Windows 10, 11 and Explorer are trademarks of Microsoft Corp.
- Apple and Mac OS are registered trademarks of Apple Inc.
- Other products may be trademarks or registered trademarks of their respective manufacturers.

Safety Instructions

- Read the installation guide thoroughly before you set up the router.
- The router is a complicated electronic unit that may be repaired only by authorized and qualified personnel. Do not try to open or repair the router yourself.
- Do not place the router in a damp or humid place, e.g. a bathroom.
- The router should be used in a sheltered area, within a temperature range of 0 to +45 Celsius.
- Do not expose the router to direct sunlight or other heat sources. The housing and electronic components may be damaged by direct sunlight or heat sources.
- Do not deploy the cable for LAN connection outdoor to prevent electronic shock hazards.
- Do not power off the router when saving configurations or firmware upgrades. It may damage the data in a flash. Please disconnect the Internet connection on the router before powering it off when a TR069/ ACS server manages the router.
- Keep the package out of reach of children.
- When you want to dispose of the router, please follow local regulations on conservation of the environment.

Warranty

- We warrant to the original end user (purchaser) that the router will be free from any defects in workmanship or materials for a period of two (2) years from the date of purchase from the dealer. Please keep your purchase receipt in a safe place as it serves as proof of date of purchase. During the warranty period, and upon proof of purchase, should the product have indications of failure due to faulty workmanship and/or materials, we will, at our discretion, repair or replace the defective products or components, without charge for either parts or labor, to whatever extent we deem necessary to restore the product to proper operating condition. Any replacement will consist of a new or re-manufactured functionally equivalent product of equal value, and will be offered solely at our discretion. This warranty will not apply if the product is modified, misused, tampered with, damaged by an act of God, or subjected to abnormal working conditions. The warranty does not cover the bundled or licensed software of other vendors. Defects which do not significantly affect the usability of the product will not be covered by the warranty. We reserve the right to revise the manual and online documentation and to make changes from time to time in the contents hereof without obligation to notify any person of such revision or changes.

Table of Contents

Part I Installation	1
I-1 Introduction	2
I-1-1 Indicators and Connectors	3
I-2 Hardware Installation	5
I-2-1 Installing Vigor Router	5
I-2-2 Rack-Mounted Installation	6
I-3 Accessing Web Page	7
I-4 Changing Password	9
I-5 Dashboard	10
I-5-1 Virtual Panel	11
I-5-2 Quick Access for Common Used Menu	12
I-5-3 GUI Map	13
I-5-4 Web Console	14
I-5-5 Config Backup	14
I-5-6 Manual Download	15
I-5-7 Logout	15
I-5-8 Online Status	16
I-5-8-1 Physical Connection	16
I-5-8-2 Virtual WAN	18
I-6 Quick Start Wizard	19
I-6-1 For WAN1 (Fiber)	20
I-6-2 For WAN3 (Ethernet - 2.5G)	27
I-6-3 For WAN5~WAN8 (Etherent)	34
I-7 Service Activation Wizard	41
I-8 Registering Vigor Router	43
I-9 VPN Client Wizard	46
I-10 VPN Server Wizard	53
Part II Connectivity	63
II-1 Port Setup	64
II-2 WAN	65
Web User Interface	66
II-2-1 General Setup	66
II-2-2 Internet Access	71
II-2-2-1 Details Page for PPPoE	73
II-2-2-2 Details Page for Static or Dynamic IP	76
II-2-2-3 Details Page for IPv6 - Offline in Ethernet WAN	80
II-2-2-4 Details Page for IPv6 - PPP	80
II-2-2-5 Details Page for IPv6 - TSPC	81
II-2-2-6 Details Page for IPv6 - AICCU	83
II-2-2-7 Details Page for IPv6 - DHCPv6 Client	85
II-2-2-8 Details Page for IPv6 - Static IPv6	86

II-2-2-9 Details Page for IPv6 - 6in4 Static Tunnel	87
II-2-2-10 Details Page for IPv6 - 6rd	90
II-2-3 Multi-VLAN	92
II-2-4 WAN Budget	96
II-2-4-1 General Setup	96
II-2-4-2 Status	99
II-3 LAN	100
Web User Interface	102
II-3-1 General Setup	102
II-3-1-1 Details Page for LAN1 - Ethernet TCP/IP and DHCP Setup	103
II-3-1-2 Details Page for IP Routed Subnet	106
II-3-1-3 Details Page for LAN1 - IPv6 Setup	108
II-3-1-4 DHCP Server Option	112
II-3-2 VLAN	113
II-3-3 Bind IP to MAC	115
II-3-4 Port Mirror/Packet Capture	118
II-3-5 Wired 802.1X	121
II-3-6 PPPoE Server	122
II-4 NAT	123
Web User Interface	124
II-4-1 Port Redirection	124
II-4-2 Server Load Balance	128
II-4-3 DMZ Host	130
II-4-4 Open Ports	133
II-4-5 Port Triggering	135
II-4-6 Port Knocking	139
II-4-7 Fast NAT	142
II-4-8 ALG	143
II-5 Applications	144
Web User Interface	146
II-5-1 Dynamic DNS	146
II-5-2 LAN DNS / DNS Forwarding	151
II-5-3 DNS Security	155
II-5-3-1 General Setup	155
II-5-3-2 Domain Diagnose	156
II-5-4 Schedule	157
II-5-5 RADIUS/TACACS+	160
II-5-5-1 External RADIUS	160
II-5-5-2 Internal RADIUS	162
II-5-5-3 External TACACS+	165
II-5-6 Active Directory/ LDAP	166
II-5-6-1 General Setup	166
II-5-6-2 Active Directory / LDAP Profiles	167
II-5-7 UPnP	168

II-5-8 IGMP	170
<i>II-5-8-1 General Setting</i>	170
<i>II-5-8-2 Working Status</i>	171
II-5-9 Wake on LAN	172
II-5-10 SMS / Mail Alert Service	173
<i>II-5-10-1 SMS Alert</i>	173
<i>II-5-10-2 Mail Alert</i>	174
II-5-11 Bonjour	175
II-5-12 High Availability	178
<i>II-5-12-1 General Setup</i>	178
<i>II-5-12-2 Config Sync</i>	180
II-5-13 Local 802.1X General Setup	182
II-5-14 Smart Action	184
Application Notes	187
<i>A-1 How to use DrayDDNS?</i>	187
II-6 Routing	192
Web User Interface	193
II-6-1 Static Route	193
II-6-2 Load-Balance/Route Policy	198
<i>II-6-2-1 General Setup</i>	198
<i>II-6-2-2 Diagnose for Route Policy</i>	204
II-6-3 Fast Routing	208
II-6-4 OSPF	209
II-6-5 BGP	211
<i>II-6-4-1 Basic Settings</i>	212
<i>II-6-4-2 Static Network</i>	213
Application Notes	214
<i>A-1 How to Customize a Secure Route between VPN Router and Remote Router by Using Route Policy</i>	214
Part III VPN	217
III-1 VPN and Remote Access	218
Web User Interface	219
III-1-1 Remote Access Control	220
<i>III-1-1-1 Remote Access Control Setup</i>	220
<i>III-1-1-2 Bind to WAN</i>	221
III-1-2 PPP General Setup	222
III-1-3 SSL General Setup	225
III-1-4 IPsec General Setup	226
III-1-5 IPsec Peer Identity	229
III-1-6 VPN Matcher Setup	231
III-1-7 OpenVPN	233
<i>III-1-7-1 OpenVPN Server Setup</i>	233
<i>III-1-7-2 Client Config</i>	236
<i>III-1-7-3 Import Certificate</i>	238
III-1-8 WireGuard	239

III-1-9 Remote Dial-in User	240
III-1-10 LAN to LAN.....	247
III-1-11 VPN Trunk Management.....	257
III-1-12 Connection Management	262
III-2 Certificate Management.....	264
Web User Interface	265
III-2-1 Local Certificate.....	265
III-2-2 Trusted CA Certificate	270
III-2-3 Certificate Backup	273
III-2-4 Self-Signed Certificate.....	274

Part IV Security 275

IV-1 Firewall.....	276
Web User Interface	278
IV-1-1 General Setup	278
IV-1-2 Filter Setup.....	283
IV-1-3 Defense Setup	293
IV-1-3-1 DoS Defense	293
IV-1-3-2 Spoofing Defense.....	296
IV-1-4 Diagnose	296
Application Notes	299
A-1 How to Configure Certain Computers Accessing to Internet	299
IV-2 CSM (Central Security Management).....	302
Web User Interface	303
IV-2-1 APP Enforcement Profile	303
IV-2-2 URL Content Filter Profile	305
IV-2-3 Web Content Filter Profile.....	309
IV-2-4 DNS Filter Profile	312
Application Notes	314
A-1 How to Create an Account for MyVigor	314
A-2 How to Block Facebook Service Accessed by the Users via Web Content Filter / URL Content Filter.....	318
A-3 How to use APP Enforcement to block application like Facebook, YouTube or TeamViewer?.....	323

Part V Management 327

V-1 System Maintenance	328
Web User Interface	329
V-1-1 System Status	329
V-1-2 TR-069	331
V-1-2-1 ACS and CPE Settings	331
V-1-2-2 Reporting Configuration	334
V-1-2-3 Export Parameters.....	335
V-1-3 Administrator Password	337
V-1-4 User Password.....	340

V-1-5 Login Page Greeting	343
V-1-6 Configuration Backup.....	345
V-1-7 Configuration Export	347
V-1-8 Webhook	348
V-1-9 Syslog/Mail Alert	349
V-1-10 Time and Date.....	352
V-1-11 SNMP.....	352
V-1-12 Management	355
V-1-13 Self-Signed Certificate	360
V-1-14 Reboot System.....	362
V-1-15 Firmware Upgrade	363
V-1-16 Internal Service User List.....	364
V-1-17 Dashboard Control	365
V-1-18 Max Connection	365
V-2 Bandwidth Management	366
Web User Interface	367
V-2-1 Sessions Limit.....	367
V-2-2 Bandwidth Limit.....	369
V-2-3 Quality of Service	371
V-2-4 APP QoS.....	377
V-3 User Management	378
Web User Interface	379
V-3-1 General Setup.....	379
V-3-2 User Profile	381
V-3-3 User Group.....	386
V-3-4 User Online Status	387
V-3-5 PPPoE User Online Status	388
Application Notes	389
<i>A-1 How to authenticate clients via User Management</i>	<i>389</i>
<i>A-2 How to use Landing Page Feature</i>	<i>396</i>
V-4 Hotspot Web Portal.....	402
Web User Interface	402
V-4-1 Profile Setup.....	402
<i>V-4-1-1 Login Method</i>	<i>403</i>
<i>V-4-1-2 Steps for Configuring a Web Portal Profile.....</i>	<i>404</i>
V-4-2 Users Information.....	420
<i>V-4-2-1 User Info.....</i>	<i>420</i>
<i>V-4-2-2 Database Setup.....</i>	<i>422</i>
V-4-3 Quota Management	424
V-4-4 PIN Generator	427
<i>V-4-4-1 PIN Status</i>	<i>427</i>
<i>V-4-4-2 PIN Generator</i>	<i>428</i>
<i>V-4-4-3 PIN Voucher</i>	<i>429</i>

Application Notes	431
<i>A-1 How to allow users login to Vigor's Hotspot with their social media accounts (e.g., Facebook & Google)</i>	<i>431</i>
<i>A-2 How to allow hotspot clients to get login PIN code via SMS?.....</i>	<i>439</i>
V-5 Central Management (AP)	447
Web User Interface	448
V-5-1 Dashboard.....	448
V-5-2 Status	449
V-5-3 WLAN Profile.....	450
V-5-4 AP Maintenance.....	455
V-5-5 Traffic Graph	456
V-5-6 Event Log	457
V-5-7 Total Traffic	458
V-5-8 Station Number	458
V-5-9 Load Balance	459
V-6 Central Management (Switch)	461
Web User Interface	462
V-6-1 Status	462
<i>V-6-1-1 Switch Status</i>	<i>462</i>
<i>V-6-1-2 Switch Hierarchy.....</i>	<i>464</i>
<i>V-6-1-3 Detailed Info.....</i>	<i>465</i>
<i>V-6-1-4 TR069 Setting.....</i>	<i>466</i>
V-6-2 Profile	467
V-6-3 Group	470
V-6-4 Maintenance.....	472
V-6-5 Alert and Log.....	473
<i>V-6-5-1 Alert Setup.....</i>	<i>473</i>
<i>V-6-5-2 Switch and Port Setup</i>	<i>474</i>
<i>V-6-5-3 Alert Logs</i>	<i>475</i>
V-6-6 Database Setup	476
V-6-7 Support List	477
V-7 Central Management (External Devices).....	478
Part VI Others	479
VI-1 Objects Settings.....	480
Web User Interface	481
VI-1-1 IP Object	481
VI-1-2 IP Group.....	485
VI-1-3 IPv6 Object.....	486
VI-1-4 IPv6 Group	488
VI-1-5 Service Type Object.....	489
VI-1-6 Service Type Group	491
VI-1-7 Keyword Object.....	493
VI-1-8 Keyword Group	495

VI-1-9 File Extension Object	496
VI-1-10 SMS/Mail Service Object	498
VI-1-11 Notification Object	503
VI-1-12 String Object	505
VI-1-13 Country Object	506
VI-1-14 Objects Backup/Restore	508
Application Notes	509
<i>A-1 How to Send a Notification to Specified Phone Number via SMS Service in WAN Disconnection</i>	509
VI-2 USB Application	513
Web User Interface	514
VI-2-1 USB General Settings	514
VI-2-2 USB User Management	514
VI-2-3 File Explorer	516
VI-2-4 USB Device Status	518
VI-2-5 Temperature Sensor	519
Part VII Troubleshooting	521
VII-1 Diagnostics	522
Web User Interface	523
VII-1-1 Dial-out Triggering	523
VII-1-2 Routing Table	524
VII-1-3 ARP Cache Table	525
VII-1-4 IPv6 Neighbour Table	526
VII-1-5 DHCP Table	527
VII-1-6 NAT Sessions Table	528
VII-1-7 DNS Cache Table	529
VII-1-8 Ping Diagnosis	530
VII-1-9 Data Flow Monitor	532
VII-1-10 Port Statistics	534
VII-1-11 Port Mirror/Packet Capture	534
VII-1-12 Traffic Graph	537
VII-1-13 VPN Graph	538
VII-1-14 Trace Route	542
VII-1-15 Syslog Explorer	543
VII-1-16 IPv6 TSPC Status	544
VII-1-17 High Availability Status	545
VII-1-18 Authentication Information	547
VII-1-19 DoS Flood Table	548
VII-1-20 Route Policy Diagnosis	549
VII-1-21 Debug Logs	551
VII-2 Checking If the Hardware Status Is OK or Not	552

VII-3 Checking If the Network Connection Settings on Your Computer Is OK or Not.....	553
VII-4 Pinging the Router from Your Computer	556
VII-5 Checking If the ISP Settings are OK or Not.....	558
VII-6 Backing to Factory Default Setting If Necessary	559
VII-7 Contacting DrayTek	560
Part VIII Telnet Commands.....	561
Accessing Telnet of Vigor3912	562

Part I Installation



Installation

This part will introduce Vigor router and guide to install the device in hardware and software.

I-1 Introduction

This is a generic International version of the user guide. Specification, compatibility and features vary by region. For specific user guides suitable for your region or product, please contact local distributor.

Vigor3912 Series, a broadband router, integrates IP layer QoS, NAT session/bandwidth management to help users control works well with large bandwidth.

By adopting hardware-based VPN platform and hardware encryption of AES/DES/3DES, the router increases the performance of VPN greatly and offers several protocols (such as IPSec/PPTP/L2TP) with up to 500 VPN tunnels.

The object-based design used in SPI (Stateful Packet Inspection) firewall allows users to set firewall policy easily. CSM (Content Security Management) provides users control and management in IM (Instant Messenger) and P2P (Peer to Peer) more efficiency than before. By the way, DoS/DDoS prevention and URL/Web content filter strengthen the security outside and control inside.

Object-based firewall is flexible and allows your network be safe.



I-1-1 Indicators and Connectors

Before you use the Vigor router, please get acquainted with the LED indicators and connectors first.

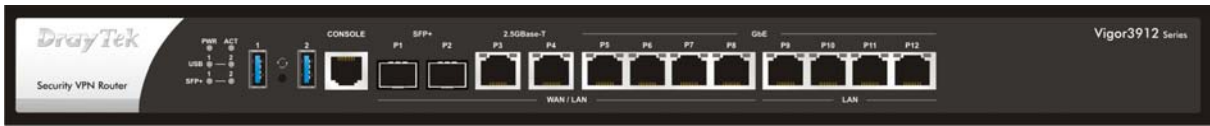

LED	Status	Explanation	
PWR	On	The router is powered on.	
	Off	The router is powered off.	
PWR	On	The router is powered on.	
	Off	The router is powered off.	
ACT	Blinking	The system is active.	
	Off	The system is hanged.	
USB	On	The USB device is installed and ready.	
	Off	No USB device is installed.	
SFP+	On	The fiber connection is established.	
	Off	No fiber connection is established or the system is hanged.	
P3 ~	Left	On	The Ethernet link is established on corresponding port.
		Off	No Ethernet link is established.
		Blinking	The data is transmitting.
P12	Right	On	The Ethernet link is established on corresponding port with 1G Mbps or above.
		Off	The Ethernet link is established on corresponding port with less than 1G Mbps.



Interface	Description
USB1 / USB2	Connector for the USB device.
Console	Provided for technician use.
SFP+ P1~P2	Connector for SFP module with the rate of 10G/1G bps.
2.5GBase-T (P3~P4)	Connector for remote network devices or local network devices (WAN/LAN) with the rate of 2.5G/1G/100M/10M bps.
GbE P5~P8	Connectors for remote network devices or local network devices (WAN/LAN) with the rate of 1G/100M/10M bps.
GbE P9~P12	Connector for local network devices (LAN) with the rate of 1G/100M/10M bps.
	The Factory Reset button is used to restore the default settings. Turn on the router (ACT LED is blinking). Press the hole and keep for more than 5 seconds. When you see the ACT LED begins to blink rapidly than usual, release the button. Then the router will restart with the factory default configuration.
	Connector for a power cord. ON/OFF - Power switch.

I-2 Hardware Installation

I-2-1 Installing Vigor Router

Before starting to configure the router, you have to connect your devices correctly.

1. Connect a modem to any WAN port of Vigor3912 with Ethernet cable (RJ-45) to access Internet.
2. Connect the other end of the cable (RJ-45) to the Ethernet port on your computer (that device also can connect to other computers to form a small area network). The LAN LED for that port on the front panel will light up.
3. Connect a server/router (depends on your requirement) to any WAN port of Vigor3912 with Ethernet cable (RJ-45). The WAN LED will light up.
4. Connect the power cord to Vigor3912's power port on the rear panel, and the other side into a wall outlet.
5. Power on the device by pressing down the power switch on the rear panel. The PWR LED should be ON.
6. The system starts to initiate. After completing the system test, the ACT LED will light up and start blinking.

Below shows an outline of the hardware installation for your reference.

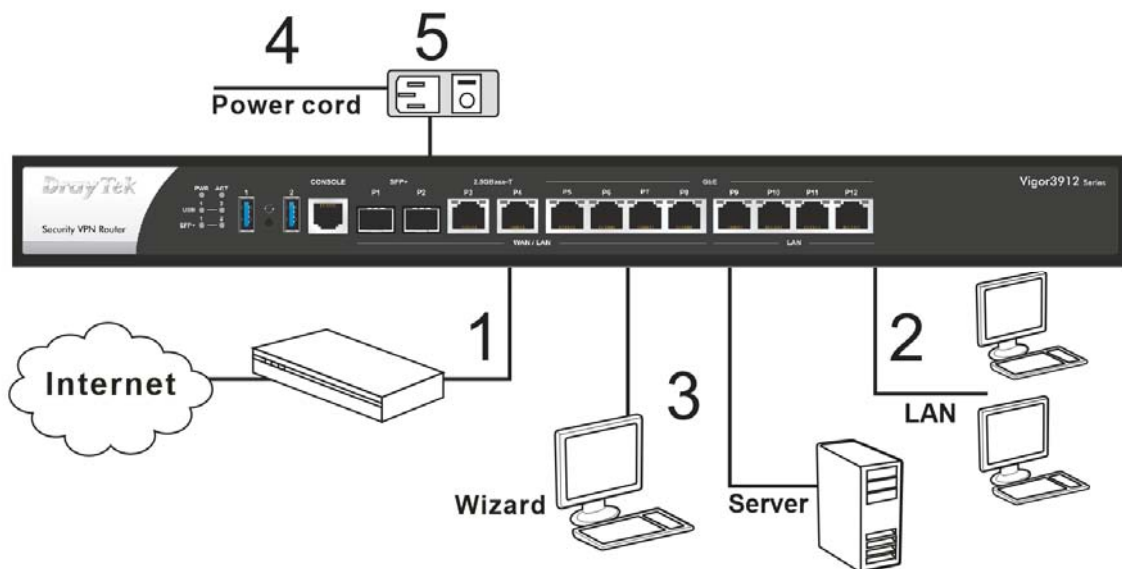

I-2-2 Rack-Mounted Installation

The Vigor3912 Series can be mounted on the wall by using standard brackets shown below.

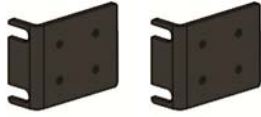

Attach the brackets to the chassis of a rack. The second bracket attaches the other side of the chassis.

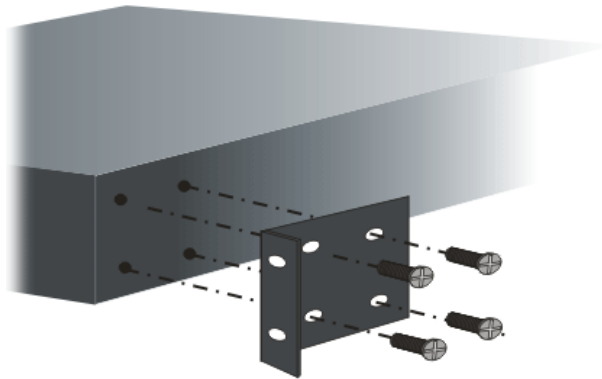

After the bracket installation, the Vigor3912 Series chassis can be installed in a rack by using four screws for each side of the rack.



Desktop Type Installation

Rubber pads are included with the Vigor3912 Series. These rubber pads improve the air circulation and decrease unnecessary rubbing on the desktop.

I-3 Accessing Web Page

1. Make sure your PC connects to the router correctly.
You may either simply set up your computer to get IP dynamically from the router or set up the IP address of the computer to be the same subnet as the **default IP address of Vigor router 192.168.1.1**. For the detailed information, please refer to the later section - Trouble Shooting of the guide.
2. Open a web browser on your PC and type **http://192.168.1.1**. The following window will be open to ask for username and password.

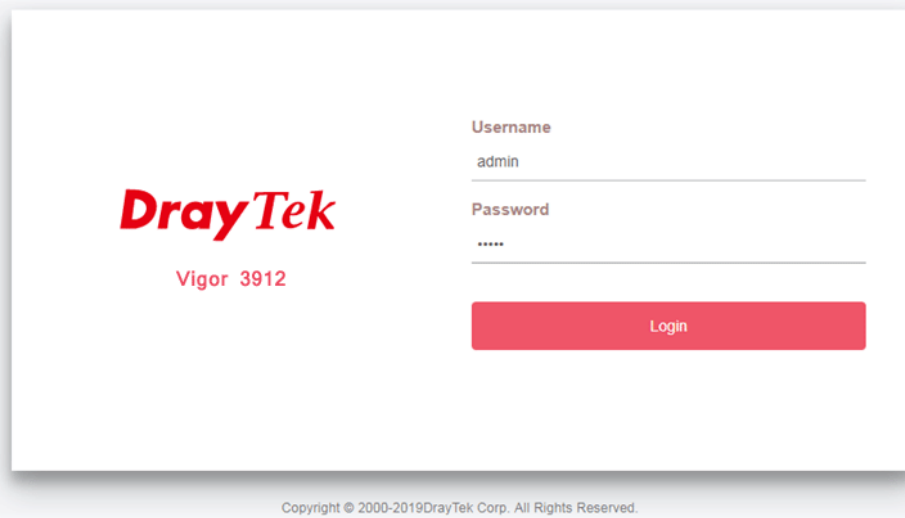

DrayTek
Vigor 3912

Username
admin

Password

Login

Copyright © 2000-2019 DrayTek Corp. All Rights Reserved.

3. Please type "admin/admin" as the Username/Password and click **Login**.



Info

If you fail to access to the web configuration, please go to "Trouble Shooting" for detecting and solving your problem.

- Now, the Main Screen will appear.

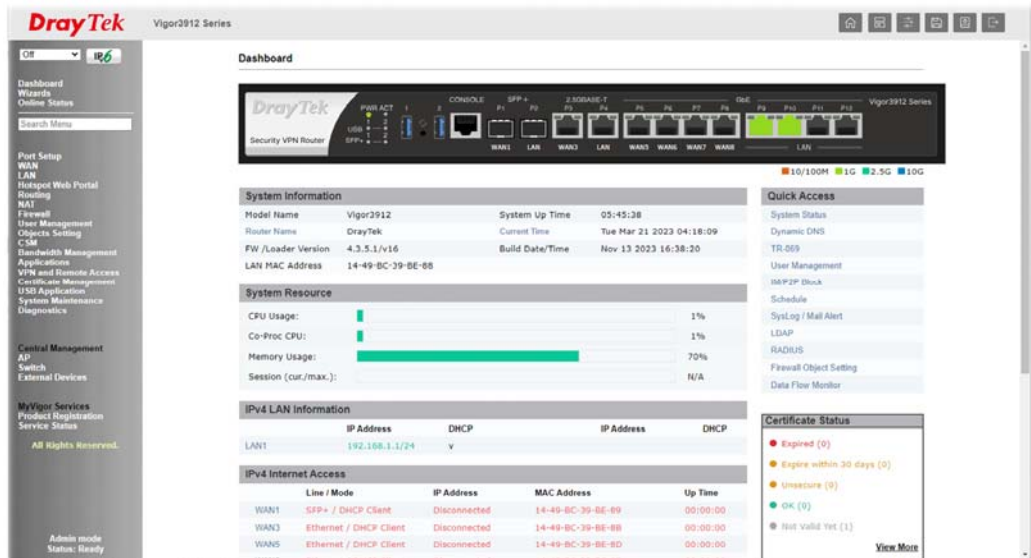

Info

The home page will be different slightly in accordance with the type of the router you have.

- The web page can be logged out according to the chosen condition. The default setting is **Auto Logout**, which means the web configuration system will logout after 5 minutes without any operation. Change the setting for your necessity.

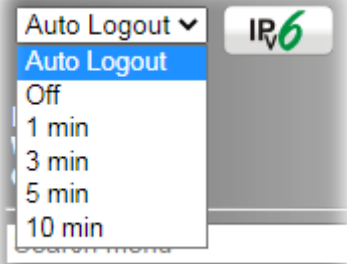

I-4 Changing Password

Please change the password for the original security of the router.

1. Open a web browser on your PC and type <http://192.168.1.1>. A pop-up window will open to ask for username and password.
2. Please type "admin/admin" as Username/Password for accessing into the web user interface with admin mode.
3. Go to **System Maintenance** page and choose **Administrator Password**.

System Maintenance >> Administrator Password

Administrator Password

Old Password	<input type="text" value="Max: 83 characters"/>
New Password	<input type="text" value="Max: 83 characters"/>
Confirm Password	<input type="text" value="Max: 83 characters"/>

Password Strength: Weak Medium Strong

Strong password requirements:
1. Have at least one upper-case letter and one lower-case letter.
2. Including non-alphanumeric characters is a plus.

Enable 'admin' account login to Web UI from the Internet
 Enable Advanced Authentication method when login from "WAN"
 Mobile one-Time Passwords(mOTP)

PIN Code Secret

2-Step Authentication

Send Auth code via

<input type="checkbox"/> SMS Profile	<input style="width: 50px;" type="text" value="1-???"/>	Recipient Number	<input style="width: 100px;" type="text" value=""/>
<input type="checkbox"/> Mail Profile	<input style="width: 50px;" type="text" value="1-???"/>	Mail Address	<input style="width: 100px;" type="text" value=""/>

4. Enter the login password (the default is "admin") on the field of **Old Password**. Type **New Password** and **Confirm Password**. Then click **OK** to continue.
5. Now, the password has been changed. Next time, use the new password to access the Web user interface for this router.

Username
admin

Password
.....

Language
English

Login

Copyright © 2023 DrayTek Corp



Info

Even the password is changed, the Username for logging onto the web user interface is still "admin".

I-5 Dashboard

Dashboard shows the connection status including System Information, IPv4 Internet Access, IPv6 Internet Access, Interface (physical connection), Security and Quick Access.

Click **Dashboard** from the main menu on the left side of the main page.

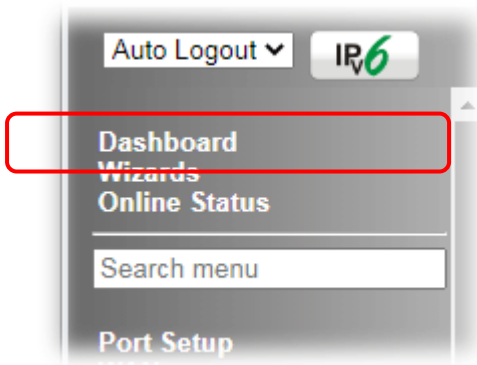

A web page with default selections will be displayed on the screen. Refer to the following figure:

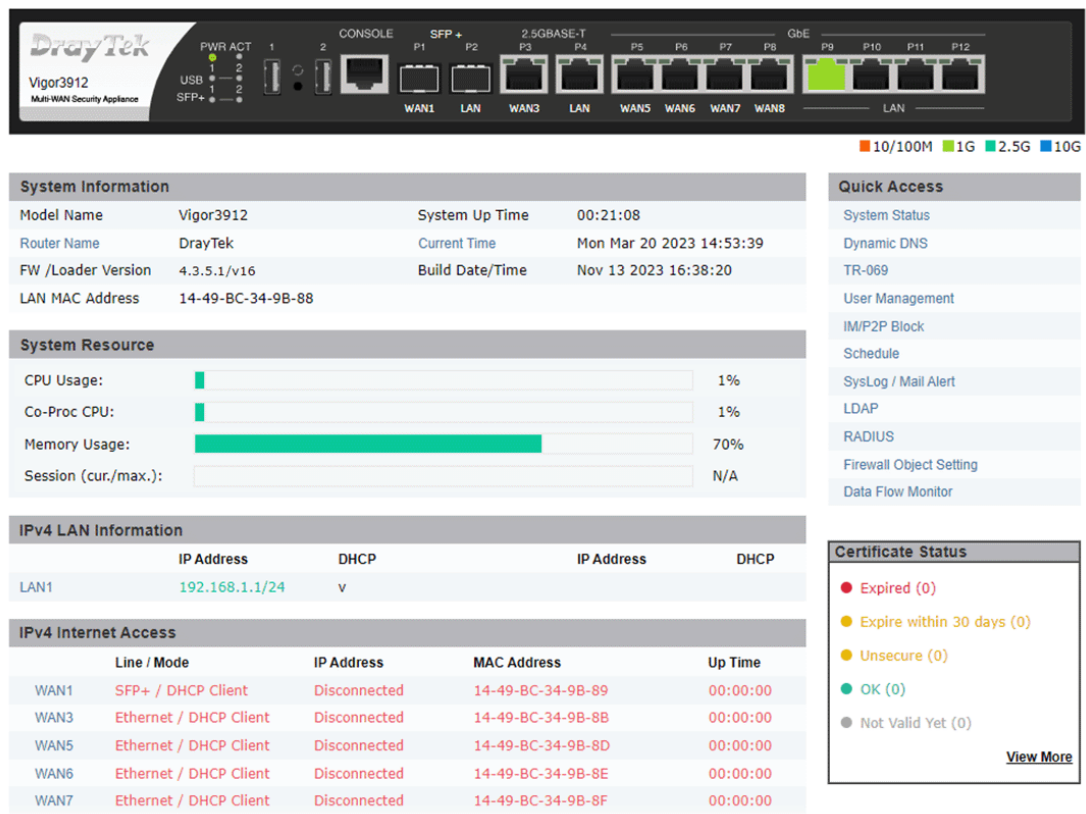

I-5-1 Virtual Panel

On the top of the Dashboard, a virtual panel (simulating the physical panel of the router) displays the physical interface connection. It will be refreshed every five seconds. When you move and click the mouse cursor on LAN, or WAN, related web setting page will be open for you to configure if required.

Dashboard

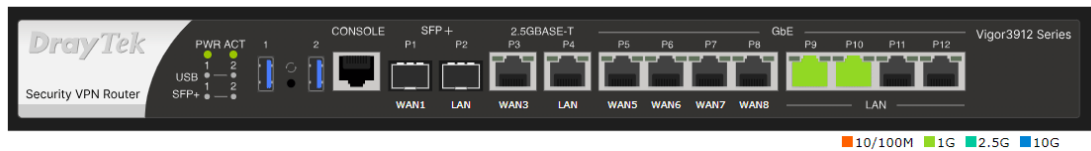

Port	Color	Description
LAN	Black	LAN port is disconnected.
	Orange	LAN port is connected at 10/100 Mbps.
	Green	LAN port is connected at 1 Gbps.
	Blue	LAN port is connected at 10 Gbps.
WAN	Black	WAN port is disconnected.
	Orange	WAN port is connected at 10/100 Mbps.
	Green	WAN port is connected at 1 Gbps.
	Blue	WAN port is connected at 10 Gbps.

For detailed information about the LED display, refer to I-1-1 LED Indicators and Connectors.

I-5-2 Quick Access for Common Used Menu

All the menu items can be accessed and arranged orderly on the left side of the main page for your request. However, some **important** and **common** used menu items which can be accessed in a quick way just for convenience.

Look at the right side of the Dashboard. You will find a group of common used functions grouped under **Quick Access**.

The function links of System Status, Dynamic DDNS, TR-069, User Management, IM/P2P Block, Schedule, Syslog/Mail Alert, LDAP, RADIUS, Firewall Object Setting and Data Flow Monitor are displayed here. Move your mouse cursor on any one of the items and click on it. The corresponding setting page will be open immediately.

Dashboard

System Information

Model Name	Vigor3912	System Up Time	00:21:08
Router Name	DrayTek	Current Time	Mon Mar 20 2023 14:53:39
FW /Loader Version	4.3.5/v16	Build Date/Time	Nov 13 2023 16:38:20
LAN MAC Address	14-49-BC-34-9B-88		

System Resource

CPU Usage:	1%
Co-Proc CPU:	1%
Memory Usage:	70%
Session (cur./max.):	N/A

IPv4 LAN Information

Line	IP Address	DHCP	IP Address	DHCP
LAN1	192.168.1.1/24	v		

IPv4 Internet Access

Line / Mode	IP Address	MAC Address	Up Time
WAN1 SFP+ / DHCP Client	Disconnected	14-49-BC-34-9B-89	00:00:00
WAN3 Ethernet / DHCP Client	Disconnected	14-49-BC-34-9B-8B	00:00:00
WAN5 Ethernet / DHCP Client	Disconnected	14-49-BC-34-9B-8D	00:00:00
WAN6 Ethernet / DHCP Client	Disconnected	14-49-BC-34-9B-8E	00:00:00
WAN7 Ethernet / DHCP Client	Disconnected	14-49-BC-34-9B-8F	00:00:00

Quick Access

- System Status
- Dynamic DNS
- TR-069
- User Management
- IM/P2P Block
- Schedule
- SysLog / Mail Alert
- LDAP
- RADIUS
- Firewall Object Setting
- Data Flow Monitor

Certificate Status

- Expired (0)
- Expire within 30 days (0)
- Unsecure (0)
- OK (0)
- Not Valid Yet (0)

[View More](#)

Besides, LAN, IP Routed Subnet, WAN interfaces, VPN security settings such as Remote Dial-in User and LAN to LAN also can be accessed on this page easily. Scroll down the page to find them and move your mouse cursor on the item to open the configuration web page.

Interface

Interface	Status	Ports
WAN	Connected : 0	WAN1, WAN3, WAN5, WAN6, WAN7, WAN8
LAN	Connected : 1	Port2, Port4, Port9, Port10, Port11, Port12

Security

VPN	Connected : 0	Remote Dial-in User / LAN to LAN
MyVigor	Activate : 0	
DoS	Attack Detected :	
RootCA		

Note that there is a plus (+) icon located on the left side of VPN/LAN. Click it to review the LAN connection(s) used presently.

Interface							
WAN	Connected : 0,	<input type="radio"/> WAN1	<input type="radio"/> WAN3	<input type="radio"/> WAN5	<input type="radio"/> WAN6	<input type="radio"/> WAN7	<input type="radio"/> WAN8
LAN	Connected : 1,	<input type="radio"/> Port2	<input type="radio"/> Port4	<input checked="" type="radio"/> Port9	<input checked="" type="radio"/> Port10	<input type="radio"/> Port11	<input type="radio"/> Port12
	Host ID	IP Address	MAC			Port	
	CarrieNi	192.168.1.10	08-BF-B8-D5-DD-A9			P9	

Security		
<input checked="" type="checkbox"/> VPN	Connected : 0	Remote Dial-in User / LAN to LAN
<input checked="" type="checkbox"/> MyVigor	Activate : 0	

All of the hosts (including wireless clients) displayed with Host ID, IP Address and MAC address indicates that the traffic would be transmitted through LAN port(s) and then the WAN port. The purpose is to perform the traffic monitor of the host(s).

I-5-3 GUI Map



All the functions the router supports are listed with table clearly in this page. Users can click the function link to access into the setting page of the function for detailed configuration. Click the icon on the top of the main screen to display all the functions.

GUI Map

Dashboard		VPN and Remote Access	Remote Access Control
Wizards	Quick Start Wizard		PPP General Setup
	Service Activation Wizard		SSL General Setup
	VPN Client Wizard		IPsec General Setup
	VPN Server Wizard		IPsec Peer Identity
Online Status	Physical Connection		VPN Matcher Setup
	Virtual WAN		OpenVPN
Port Setup			WireGuard
WAN	General Setup		Remote Dial-in User
	Internet Access		LAN to LAN
	Multi-VLAN		VPN TRUNK Management
	WAN Budget	Certificate Management	Connection Management
LAN	General Setup		Local Certificate
	VLAN		Trusted CA Certificate
	Bind IP to MAC	USB Application	Certificate Backup
	Port Mirror/Packet Capture		Self-Signed Certificate
	Wired 802.1X		USB General Settings
	PPPoE Server		USB User Management
Hotspot Web Portal			File Explorer
			USB Device Status

I-5-4 Web Console

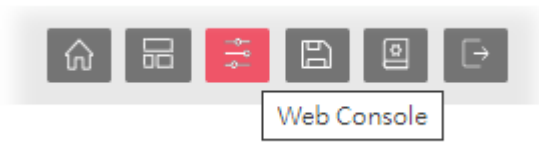

It is not necessary to use the telnet command via DOS prompt. The changes made by using web console have the same effects as modified through web user interface. The functions/settings modified under Web Console also can be reviewed on the web user interface.

Click the **Web Console** icon on the top of the main screen to open the following screen.



I-5-5 Config Backup

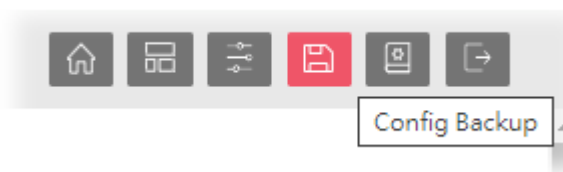

There is one way to store current used settings quickly by clicking the **Config Backup** icon. It allows you to backup current settings as a file. Such configuration file can be restored by using **System Maintenance>>Configuration Backup**.

Simply click the icon on the top of the main screen.

I-5-6 Manual Download

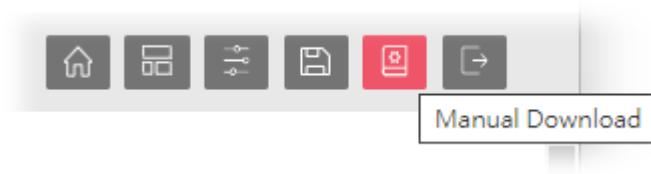

Click this icon to open online user's guide of Vigor router. This document offers detailed information for the settings on web user interface.

I-5-7 Logout

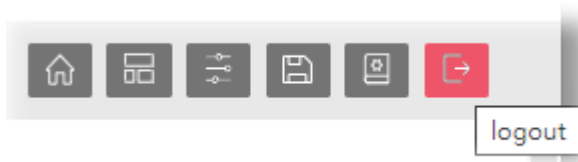

Click this icon to exit the web user interface.

I-5-8 Online Status

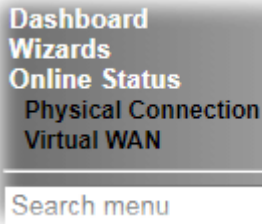

I-5-8-1 Physical Connection

Such page displays the physical connection status such as LAN connection status, WAN connection status, ADSL information, and so on.

Physical Connection for IPv4 Protocol

Online Status

Physical Connection				System Uptime: 6days 7:14:11	
IPv4		IPv6			
LAN Status					
IP Address	TX Packets	RX Packets	Router Primary DNS:	Router Secondary DNS:	
192.168.1.1	260,444	128,959	8.8.8.8	8.8.4.4	
WAN 1 Status >> Renew					
Enable	Line	Name	Mode	Up Time	
Yes	Ethernet		DHCP Client	00:00:00	
IP	GW IP	TX Packets	TX Rate(Bps)	RX Packets	RX Rate(Bps)
---	---	0	0	0	0
WAN 3 Status >> Renew					
Enable	Line	Name	Mode	Up Time	
Yes	Ethernet		DHCP Client	00:00:00	
IP	GW IP	TX Packets	TX Rate(Bps)	RX Packets	RX Rate(Bps)
---	---	0	0	0	0
WAN 5 Status >> Renew					
Enable	Line	Name	Mode	Up Time	
Yes	Ethernet		DHCP Client	00:00:00	
IP	GW IP	TX Packets	TX Rate(Bps)	RX Packets	RX Rate(Bps)
---	---	0	0	0	0
WAN 6 Status >> Renew					
Enable	Line	Name	Mode	Up Time	
Yes	Ethernet		DHCP Client	00:00:00	
IP	GW IP	TX Packets	TX Rate(Bps)	RX Packets	RX Rate(Bps)
---	---	0	0	0	0
WAN 7 Status >> Renew					
Enable	Line	Name	Mode	Up Time	
Yes	Ethernet		DHCP Client	00:00:00	
IP	GW IP	TX Packets	TX Rate(Bps)	RX Packets	RX Rate(Bps)
---	---	0	0	0	0
WAN 8 Status >> Renew					
Enable	Line	Name	Mode	Up Time	
Yes	Ethernet		DHCP Client	00:00:00	
IP	GW IP	TX Packets	TX Rate(Bps)	RX Packets	RX Rate(Bps)
---	---	0	0	0	0

Physical Connection for IPv6 Protocol

Online Status

Physical Connection		System Uptime: 6days 7:14:46	
IPv4	IPv6		
LAN Status			
IP Address FE80::21D:AAFF:FE4B:3E90/64 (Link)			
TX Packets	RX Packets	TX Bytes	RX Bytes
2,360	1,288	184,088	113,150
WAN1 IPv6 Status			
Enable	Mode	Up Time	
No	Offline	---	
IP	Gateway IP		
---	---		
WAN3 IPv6 Status			
Enable	Mode	Up Time	
No	Offline	---	
IP	Gateway IP		
---	---		
WAN5 IPv6 Status			
Enable	Mode	Up Time	
No	Offline	---	
IP	Gateway IP		
---	---		
WAN6 IPv6 Status			
Enable	Mode	Up Time	
No	Offline	---	
IP	Gateway IP		
---	---		
WAN7 IPv6 Status			
Enable	Mode	Up Time	
No	Offline	---	
IP	Gateway IP		
---	---		
WAN8 IPv6 Status			
Enable	Mode	Up Time	
No	Offline	---	
IP	Gateway IP		
---	---		

Detailed explanation (for IPv4) is shown below:

Item	Description
LAN Status	<p>Primary DNS-Displays the primary DNS server address for WAN interface.</p> <p>Secondary DNS -Displays the secondary DNS server address for WAN interface.</p> <p>IP Address-Displays the IP address of the LAN interface.</p> <p>TX Packets-Displays the total transmitted packets at the LAN interface.</p> <p>RX Packets-Displays the total received packets at the LAN interface.</p>
WAN1 to WAN8 Status	<p>Enable - Yes in red means such interface is available but not enabled. Yes in green means such interface is enabled.</p> <p>Line - Displays the physical connection (VDSL, ADSL, Ethernet, or USB) of this interface.</p> <p>Name - Display the name of the router.</p>

Item	Description
	Mode - Displays the type of WAN connection (e.g., PPPoE). Up Time - Displays the total uptime of the interface. IP - Displays the IP address of the WAN interface. GW IP - Displays the IP address of the default gateway. TX Packets - Displays the total transmitted packets at the WAN interface. TX Rate - Displays the speed of transmitted octets at the WAN interface. RX Packets - Displays the total number of received packets at the WAN interface. RX Rate - Displays the speed of received octets at the WAN interface.

Detailed explanation (for IPv6) is shown below:

Item	Description
LAN Status	IP Address - Displays the IPv6 address of the LAN interface. TX Packets -Displays the total transmitted packets at the LAN interface. RX Packets -Displays the total received packets at the LAN interface. TX Bytes - Displays the speed of transmitted octets at the LAN interface. RX Bytes - Displays the speed of received octets at the LAN interface.
WAN1 to WAN8 IPv6 Status	Enable - No in red means such interface is available but not enabled. Yes in green means such interface is enabled. No in red means such interface is not available. Mode - Displays the type of WAN connection (e.g., TSPC). Up Time - Displays the total uptime of the interface. IP - Displays the IP address of the WAN interface. Gateway IP - Displays the IP address of the default gateway.



Info

The words in green mean that the WAN connection of that interface is ready for accessing Internet; the words in red mean that the WAN connection of that interface is not ready for accessing Internet.

I-5-8-2 Virtual WAN

Such page displays the virtual WAN connection information.

Virtual WAN are used by TR-069 management, VoIP service and so on.

The field of Application will list i-9the purpose of such WAN connection.

I-6 Quick Start Wizard

Quick Start Wizard can help you to deploy and use the router easily and quickly. Go to **Wizards>>Quick Start Wizard**. The first screen of **Quick Start Wizard** is entering login password. After typing the password, please click **Next**.

Wizards >> Quick Start Wizard

Enter login password

Please enter an alpha-numeric string as your **Password** (Max 83 characters)

Old Password

New Password

Confirm Password

Password Strength:

Strong password requirements:

1. Have at least one upper-case letter and one lower-case letter.
2. Including non-alphanumeric characters is a plus.

Hint: If you want to keep the password unchanged, leave the password blank and press "Next" button to skip this process.

On the next page as shown below, please select the WAN interface that you use. If fiber is used, please choose WAN1; if Ethernet is used, please choose WAN3 ~ WAN8. Then click **Next** for next step.

Wizards >> Quick Start Wizard

Select WAN Interface

Select WAN Interface:

Display Name:

Physical Mode:

Physical Type:

WAN1 and WAN2 will bring up different configuration page. Refer to the following for detailed information.

I-6-1 For WAN1 (Fiber)

WAN1 can be configured for physical mode of SFP+ (Fiber connection).

Quick Start Wizard

WAN Interface

WAN Interface:	WAN1 ▾
Display Name:	<input type="text"/>
Physical Mode:	SFP+
Physical Type:	Auto negotiation ▾

< Back

Next >

Finish

Cancel

Available settings are explained as follows:

Item	Description
Display Name	Enter a name for the router.
Physical Type	This setting will vary based on the Physical Mode. In general, Auto negotiation is suggested.

On the next page as shown below, please select the appropriate Internet access type according to the information from your ISP. For example, you should select PPPoE mode if the ISP provides you PPPoE interface. Then click **Next** for next step.

Ethernet WAN1 - PPPoE

1. Choose **WAN1** as the WAN Interface. Click the **Next** button. The following page will be open for you to specify Internet Access Type.

Quick Start Wizard

Connect to Internet

WAN 1
Select one of the following Internet Access types provided by your ISP.

PPPoE
 Static IP
 DHCP

< Back Next > Finish Cancel

2. Click PPPoE as the Internet Access Type to get the following page.

Quick Start Wizard

PPPoE Client Mode

WAN 1
Enter the user name and password provided by your ISP.

Service Name (Optional) CHT

Username 84005657@hinet.net

Password

Confirm Password

< Back Next > Finish Cancel

Available settings are explained as follows:

Item	Description
Service Name (Optional)	Enter the description of the specific network service.
Username	Assign a specific valid user name provided by the ISP. Note: The maximum length of the user name you can set is 63 characters.
Password	Assign a valid password provided by the ISP. Note: The maximum length of the password you can set is 62 characters.

Item	Description
Confirm Password	Re-enter the password.
Back	Click it to return to previous setting page.
Next	Click it to get into the next setting page.
Cancel	Click it to give up the quick start wizard.

- Please manually enter the Username/Password provided by your ISP. Click Next for viewing summary of such connection.

Quick Start Wizard

Please confirm your settings:

WAN Interface:	WAN1
Physical Mode:	SFP+
Internet Access:	PPPoE

Click **Back** to modify changes if necessary. Otherwise, click **Finish** to save the current settings and restart the Vigor router.

- Click **Finish**. A page of **Quick Start Wizard Setup OK!!!** will appear. Then, the system status of this protocol will be shown.

Quick Start Wizard Setup OK!

- Now, you can enjoy surfing on the Internet.

Ethernet WAN1 - Static IP

1. Choose **WAN1** as the WAN Interface. Click the **Next** button. The following page will be open for you to specify Internet Access Type.

Quick Start Wizard

Connect to Internet

WAN 1
Select one of the following Internet Access types provided by your ISP.

PPPoE
 Static IP
 DHCP

< Back Next > Finish Cancel

2. Click **Static IP** as the Internet Access type to get the following page.

Wizards >> Quick Start Wizard

Static IP Client Mode

WAN 1
Enter the Static IP configuration provided by your ISP.

WAN IP	<input type="text" value="192.168.3.100"/>
Subnet Mask	<input type="text" value="255.255.255.0"/>
Gateway	<input type="text" value="192.168.3.1"/>
Primary DNS	<input type="text" value="8.8.8.8"/>
Secondary DNS	<input type="text" value="8.8.4.4"/> (optional)

< Back Next > Finish Cancel

Available settings are explained as follows:

Item	Description
WAN IP	Enter the IP address.
Subnet Mask	Enter the subnet mask.
Gateway	Enter the IP address of gateway.
Primary DNS	Enter the primary IP address for the router.
Secondary DNS	Enter the secondary IP address for necessity in the future.
Back	Click it to return to previous setting page.
Next	Click it to get into the next setting page.

Cancel	Click it to give up the quick start wizard.
--------	---

3. Please Enter the IP address information originally provided by your ISP. Then click **Next** for next step.

Quick Start Wizard

Please confirm your settings:

WAN Interface:	WAN1
Physical Mode:	SFP+
Internet Access:	Static IP

Click **Back** to modify changes if necessary. Otherwise, click **Finish** to save the current settings and restart the Vigor router.

4. Click **Finish**. A page of **Quick Start Wizard Setup OK!!!** will appear. Then, the system status of this protocol will be shown.

Quick Start Wizard Setup OK!

5. Now, you can enjoy surfing on the Internet.

Ethernet WAN1 - DHCP

1. Choose **WAN1** as the WAN Interface. Click the **Next** button. The following page will be open for you to specify Internet Access Type.

Quick Start Wizard

Connect to Internet

WAN 1
Select one of the following Internet Access types provided by your ISP.

PPPoE
 Static IP
 DHCP

2. Click **DHCP** as the Internet Access type to get the following page.

Quick Start Wizard

DHCP Client Mode

WAN 1
If your ISP requires you to enter a specific host name or specific MAC address, please enter it in.

Host Name (optional)

MAC (optional)

Available settings are explained as follows:

Item	Description
Host Name	Enter the name of the host. Note: The maximum length of the host name you can set is 39 characters.
MAC	Some Cable service providers specify a specific MAC address for access authentication. In such cases you need to enter the MAC address.
Back	Click it to return to previous setting page.
Next	Click it to get into the next setting page.

Cancel	Click it to give up the quick start wizard.
--------	---

3. After finished the settings above, click **Next** for viewing summary of such connection.

Quick Start Wizard

Please confirm your settings:

WAN Interface:	WAN1
Physical Mode:	SFP+
Internet Access:	DHCP

Click **Back** to modify changes if necessary. Otherwise, click **Finish** to save the current settings and restart the Vigor router.

4. Click **Finish**. A page of **Quick Start Wizard Setup OK!!!** will appear. Then, the system status of this protocol will be shown.

Quick Start Wizard Setup OK!

5. Now, you can enjoy surfing on the Internet.

I-6-2 For WAN3 (Ethernet - 2.5G)

WAN3 shall be used for connection with rate 2.5G.

Wizards >> Quick Start Wizard

Select WAN Interface

Select WAN Interface:	WAN3 ▾
Display Name:	<input type="text"/>
Physical Mode:	Ethernet
Physical Type:	Auto negotiation ▾ Auto negotiation 2.5G full duplex

< Back Next > Finish Cancel

Available settings are explained as follows:

Item	Description
Display Name	Enter a name for the router.
Physical Type	This setting will vary based on the Physical Mode. In general, Auto negotiation is suggested.

On the next page as shown below, please select the appropriate Internet access type according to the information from your ISP. For example, you should select PPPoE mode if the ISP provides you PPPoE interface. Then click **Next** for next step.

Ethernet WAN3 - PPPoE

1. Choose **WAN3** as the WAN Interface. Click the **Next** button. The following page will be open for you to specify Internet Access Type.

Quick Start Wizard

Connect to Internet

WAN 3
Select one of the following Internet Access types provided by your ISP.

PPPoE
 Static IP
 DHCP

< Back Next > Finish Cancel

- Click PPPoE as the Internet Access Type to get the following page.

Quick Start Wizard

PPPoE Client Mode

WAN 3
Enter the user name and password provided by your ISP.

Service Name (Optional)

Username

Password

Confirm Password

Available settings are explained as follows:

Item	Description
Service Name (Optional)	Enter the description of the specific network service.
Username	Assign a specific valid user name provided by the ISP. Note: The maximum length of the user name you can set is 63 characters.
Password	Assign a valid password provided by the ISP. Note: The maximum length of the password you can set is 62 characters.
Confirm Password	Re-enter the password.
Back	Click it to return to previous setting page.
Next	Click it to get into the next setting page.
Cancel	Click it to give up the quick start wizard.

3. Please manually enter the Username/Password provided by your ISP. Click **Next** for viewing summary of such connection.

Quick Start Wizard

Please confirm your settings:

WAN Interface:	WAN3
Physical Mode:	Ethernet
Internet Access:	PPPoE

Click **Back** to modify changes if necessary. Otherwise, click **Finish** to save the current settings and restart the Vigor router.

< Back

Next >

Finish

Cancel

4. Click **Finish**. A page of **Quick Start Wizard Setup OK!!!** will appear. Then, the system status of this protocol will be shown.

Quick Start Wizard Setup OK!

5. Now, you can enjoy surfing on the Internet.

Ethernet WAN3 - Static IP

1. Choose **WAN3** as the WAN Interface. Click the **Next** button. The following page will be open for you to specify Internet Access Type.

Quick Start Wizard

Connect to Internet

WAN 3
Select one of the following Internet Access types provided by your ISP.

PPPoE
 Static IP
 DHCP

2. Click **Static IP** as the Internet Access type to get the following page.

Quick Start Wizard

Static IP Client Mode

WAN 3
Enter the Static IP configuration provided by your ISP.

WAN IP	<input type="text" value="172.16.21.77"/>
Subnet Mask	<input type="text" value="255.255.255.0"/>
Gateway	<input type="text" value="172.16.21.1"/>
Primary DNS	<input type="text" value="8.8.8.8"/>
Secondary DNS	<input type="text" value="8.8.4.4"/> (optional)

Available settings are explained as follows:

Item	Description
WAN IP	Enter the IP address.
Subnet Mask	Enter the subnet mask.
Gateway	Enter the IP address of gateway.
Back	Click it to return to previous setting page.
Next	Click it to get into the next setting page.
Cancel	Click it to give up the quick start wizard.

3. Please enter the IP address information originally provided by your ISP. Then click **Next** for next step.

Quick Start Wizard

Please confirm your settings:

WAN Interface:	WAN3
Physical Mode:	Ethernet
Internet Access:	Static IP

Click **Back** to modify changes if necessary. Otherwise, click **Finish** to save the current settings and restart the Vigor router.

< Back

Next >

Finish

Cancel

4. Click **Finish**. A page of **Quick Start Wizard Setup OK!!!** will appear. Then, the system status of this protocol will be shown.

Quick Start Wizard Setup OK!

5. Now, you can enjoy surfing on the Internet.

Wireless WAN3 - DHCP

1. Choose **WAN3** as the WAN Interfac. Click the **Next** button. The following page will be open for you to specify Internet Access Type.

Quick Start Wizard

Connect to Internet

WAN 3
Select one of the following Internet Access types provided by your ISP.

PPPoE
 Static IP
 DHCP

< Back Next > Finish Cancel

2. Click **DHCP** as the Internet Access type to get the following page.

Quick Start Wizard

DHCP Client Mode

WAN 3
If your ISP requires you to enter a specific host name or specific MAC address, please enter it in.

Host Name (optional)
MAC - - - - - (optional)

< Back Next > Finish Cancel

Available settings are explained as follows:

Item	Description
Host Name	Enter the name of the host. Note: The maximum length of the host name you can set is 39 characters.
MAC	Some Cable service providers specify a specific MAC address for access authentication. In such cases you need to enter the MAC address.
Back	Click it to return to previous setting page.
Next	Click it to get into the next setting page.

Cancel	Click it to give up the quick start wizard.
--------	---

3. After finished the settings above, click **Next** for viewing summary of such connection.

Quick Start Wizard

Please confirm your settings:

WAN Interface:	WAN3
Physical Mode:	Ethernet
Internet Access:	DHCP

Click **Back** to modify changes if necessary. Otherwise, click **Finish** to save the current settings and restart the Vigor router.

4. Click **Finish**. A page of **Quick Start Wizard Setup OK!!!** will appear. Then, the system status of this protocol will be shown.

Quick Start Wizard Setup OK!

5. Now, you can enjoy surfing on the Internet.

I-6-3 For WAN5~WAN8 (Ethernet)

WAN5~WAN8 can be configured for physical mode of Ethernet.

Wizards >> Quick Start Wizard

Select WAN Interface

Select WAN Interface: WAN5 ▾
Display Name:
Physical Mode: Ethernet
Physical Type: Auto negotiation ▾
Auto negotiation
1G full duplex
100M full duplex
10M full duplex

< Back Next > Finish Cancel

Available settings are explained as follows:

Item	Description
Display Name	Enter a name for the router.
Physical Type	This setting will vary based on the Physical Mode. In general, Auto negotiation is suggested.

On the next page as shown below, please select the appropriate Internet access type according to the information from your ISP. For example, you should select PPPoE mode if the ISP provides you PPPoE interface. Then click **Next** for next step.

Ethernet WAN5 - PPPoE

1. Choose **WAN5** as the WAN Interface. Click the **Next** button. The following page will be open for you to specify Internet Access Type.

Quick Start Wizard

Connect to Internet

WAN 5
Select one of the following Internet Access types provided by your ISP.

PPPoE
 Static IP
 DHCP

< Back Next > Finish Cancel

2. Click PPPoE as the Internet Access Type to get the following page.

Quick Start Wizard

PPPoE Client Mode

WAN 5
Enter the user name and password provided by your ISP.

Service Name (Optional) CHT

Username 84005657@hinet.net

Password

Confirm Password

< Back Next > Finish Cancel

Available settings are explained as follows:

Item	Description
Service Name (Optional)	Enter the description of the specific network service.
Username	Assign a specific valid user name provided by the ISP. Note: The maximum length of the user name you can set is 63 characters.
Password	Assign a valid password provided by the ISP. Note: The maximum length of the password you can set is 62 characters.
Confirm Password	Re-enter the password.
Back	Click it to return to previous setting page.
Next	Click it to get into the next setting page.

Item	Description
Cancel	Click it to give up the quick start wizard.

- Please manually enter the Username/Password provided by your ISP. Click **Next** for viewing summary of such connection.

Quick Start Wizard

Please confirm your settings:

WAN Interface:	WAN5
Physical Mode:	Ethernet
Internet Access:	PPPoE
<p>Click Back to modify changes if necessary. Otherwise, click Finish to save the current settings and restart the Vigor router.</p>	

- Click **Finish**. A page of **Quick Start Wizard Setup OK!!!** will appear. Then, the system status of this protocol will be shown.

Quick Start Wizard Setup OK!

- Now, you can enjoy surfing on the Internet.

Ethernet WAN5 - Static IP

1. Choose **WAN5** as the WAN Interface. Click the **Next** button. The following page will be open for you to specify Internet Access Type.

Quick Start Wizard

Connect to Internet

WAN 5
Select one of the following Internet Access types provided by your ISP.

PPPoE
 Static IP
 DHCP

< Back Next > Finish Cancel

2. Click **Static IP** as the Internet Access type to get the following page.

Quick Start Wizard

Static IP Client Mode

WAN 5
Enter the Static IP configuration provided by your ISP.

WAN IP
Subnet Mask
Gateway
Primary DNS
Secondary DNS (optional)

< Back Next > Finish Cancel

Available settings are explained as follows:

Item	Description
WAN IP	Enter the IP address.
Subnet Mask	Enter the subnet mask.
Gateway	Enter the IP address of gateway.
Back	Click it to return to previous setting page.
Next	Click it to get into the next setting page.
Cancel	Click it to give up the quick start wizard.

3. Please enter the IP address information originally provided by your ISP. Then click **Next** for next step.

Quick Start Wizard

Please confirm your settings:

WAN Interface:	WAN5
Physical Mode:	Ethernet
Internet Access:	Static IP

Click **Back** to modify changes if necessary. Otherwise, click **Finish** to save the current settings and restart the Vigor router.

< Back

Next >

Finish

Cancel

4. Click **Finish**. A page of **Quick Start Wizard Setup OK!!!** will appear. Then, the system status of this protocol will be shown.

Quick Start Wizard Setup OK!

5. Now, you can enjoy surfing on the Internet.

Wireless WAN5 - DHCP

1. Choose **WAN5** as the WAN Interfac. Click the **Next** button. The following page will be open for you to specify Internet Access Type.

Quick Start Wizard

Connect to Internet

WAN 5
Select one of the following Internet Access types provided by your ISP.

PPPoE
 Static IP
 DHCP

< Back Next > Finish Cancel

2. Click **DHCP** as the Internet Access type to get the following page.

Quick Start Wizard

DHCP Client Mode

WAN 5
If your ISP requires you to enter a specific host name or specific MAC address, please enter it in.

Host Name (optional)
MAC - - - - - (optional)

< Back Next > Finish Cancel

Available settings are explained as follows:

Item	Description
Host Name	Enter the name of the host. Note: The maximum length of the host name you can set is 39 characters.
MAC	Some Cable service providers specify a specific MAC address for access authentication. In such cases you need to enter the MAC address.
Back	Click it to return to previous setting page.
Next	Click it to get into the next setting page.

Cancel	Click it to give up the quick start wizard.
--------	---

3. After finished the settings above, click **Next** for viewing summary of such connection.

Quick Start Wizard

Please confirm your settings:

WAN Interface:	WAN5
Physical Mode:	Ethernet
Internet Access:	DHCP

Click **Back** to modify changes if necessary. Otherwise, click **Finish** to save the current settings and restart the Vigor router.

4. Click **Finish**. A page of **Quick Start Wizard Setup OK!!!** will appear. Then, the system status of this protocol will be shown.

Quick Start Wizard Setup OK!

5. Now, you can enjoy surfing on the Internet.

I-7 Service Activation Wizard

Service Activation Wizard can guide you to activate WCF service (Web Content Filter) with a quick and easy way. For the Service Activation Wizard is only available for admin operation, therefore, please type "admin/admin" on Username/Password while Logging into the web user interface.

Service Activation Wizard is a tool which allows you to use trial version of WCF directly without accessing into the server (**MyVigor**) located on <http://myvigor.draytek.com>. For using Web Content Filter Profile, please refer to later section **Web Content Filter Profile** for detailed information.

Now, follow the steps listed below to activate WCF feature for your router.



Info

Such function is available only for Admin Mode.

1. Open Wizards>>Service Activation Wizard.

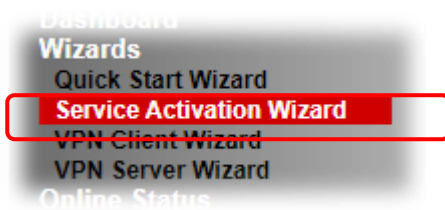

2. The screen of Service Activation Wizard will be shown as follows. You can activate the Web content filter services, APPE service and/or DDNS service at the same time or individually. When you finish the selection, please click Next.

Service Activation Wizard

Select the service type that you want to activate

Activation Date : 2024-01-11

Web Content Filter(WCF) Service :

BRJM [License Agreement](#)
This is a web content filter that is provided by the German government. It is a free service without any guarantee and will expire one year after activation. You may re-activate the service after expiry.

URL Reputation 30-Day Free Trial [License Agreement](#)
To activate the 30-day trial license, you will need a MyVigor account and register the router to the MyVigor account first. [How To...](#)
[Upgrade Firmware to v4.4.3 or later is mandatory. More Details...](#)

APP Enforcement(APPE) Service :

DT-APPE [License Agreement](#)
Upgrade APPE Signature automatically.

Dynamic DNS(DDNS) Service :

DT-DDNS [License Agreement](#)
This Dynamic Domain Name service is provided by DrayTek Corporation. To activate the DrayDDNS (Global) service, please select this option to activate the license. This is a 1-year free license key. For re-activation after expiry, you have to obtain a new license from MyVigor website (<https://myvigor.draytek.com>).

I agree to let the MyVigor server record the WAN or Internet IP address of this router in order to activate the DrayDDNS service.
You can stop this service and clear your IP address at any time.

Domain Name : .draydns.com

I have read and accept the above Agreement. (Please check this box).

Next > Cancel



Info

- BPjM is web content filter (WCF) for German Speaking users. It is ideal for your family to provide more Internet security for youngsters.
- DT-DDNS, developed by DrayTek, offers one year free charge service of dynamic DNS service for internal use.

3. Setting confirmation page will be displayed as follows, please click **Activate**.

Service Activation Wizard

Please confirm your settings

Service Type : Trial version
Service Activated : Web Content Filter (URL Reputation)

Please click **Back** to re-select service type you to activate.



Info

The service will be activated and applied as the default rule configured in Firewall>>General Setup.

4. The web page will display the service that you have activated according to your selection(s).

I-8 Registering Vigor Router

You have finished the configuration of Quick Start Wizard and you can surf the Internet at any time. Now it is the time to register your Vigor router to MyVigor website for getting more service. Please follow the steps below to finish the router registration.

- 1 Please login the web configuration interface of Vigor router by typing “admin/admin” as User Name / Password.

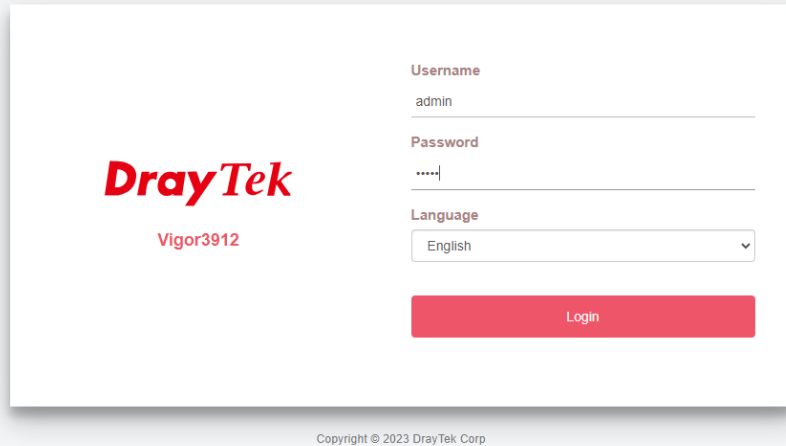

- 2 Click **Support Area**>>**Production Registration** from the home page.



Support Area
Product Registration
Service Status

- 3 A Login page will be shown on the screen. Please type the account and password that you created previously. And click **Login**.

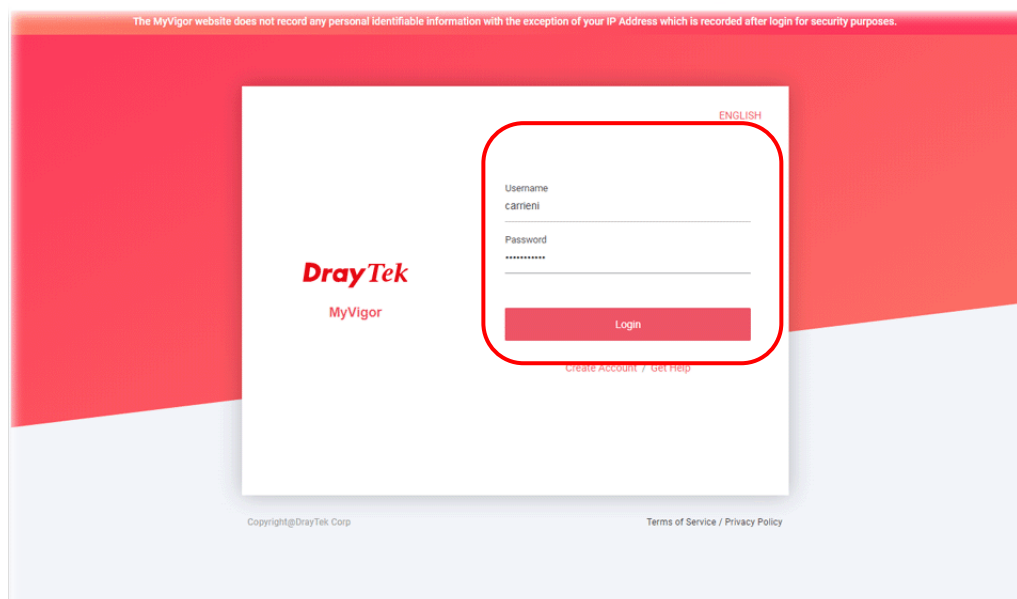

Info If you haven't an accessing account, please refer to section Creating an Account for MyVigor to create your own one. Please read the articles on the Agreement regarding user rights carefully while creating a user account.

- 4 The following page will be displayed after you logging in MyVigor. Type a nickname for the router, then click **Submit**.

Product register (Add Device)

Device Name	<input type="text"/>
Model	Vigor3912
MAC	1449BC349BC8
Serial Number	2024011114392101

Cancel Submit

- 5 When the following page appears, your router information has been added to the database. Your router has been registered to *myvigor* website successfully.

My Product > Vigor3912 > Service Status

WCF APPE DrayDDNS

URL Reputation BPJM

Upgrade Firmware to v4.4.3 or later is mandatory. [More Details...](#)

License Status ●

License Action **Activate License** Force Sync

License History

Today 2024-01-11

Product Registration 2024-01-11

- 6 Clicking **MYPRODUCT** for viewing the general information of the registered router on MyVigor website.

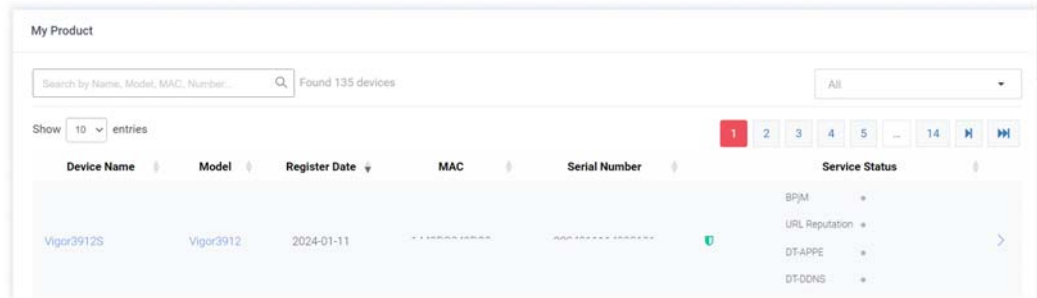

I-9 VPN Client Wizard

The VPN Client Wizard will configure the router as a *client* to connect to a remote VPN server using a LAN-to-LAN VPN tunnel. The wizard will guide you through the setup process.

1. On the menu bar, click on **Wizards**, and then **VPN Client Wizard**.

VPN Client Wizard

Choose VPN Establishment Environment

Please choose a LAN-to-LAN Profile:

Available settings are explained as follows:

Item	Description
Please choose a LAN-to-LAN Profile	The profile used to store this tunnel configuration. Selecting an index that has already been setup previously will result in the existing setup getting overwritten by the wizard.

2. When you finish the mode and profile selection, please click **Next** to open the following page.

VPN Client Wizard

VPN Connection Setting

<p>Security Ranking:</p> <p>Very High IPsec XAuth IPsec IKEv2 EAP (only for NAT Mode) L2TP over IPsec OpenVPN (AES256)</p> <p>High IPsec IKEv1/IKEv2 SSL OpenVPN (AES128)</p> <p>Medium PPTP (Encryption)</p> <p>Low L2TP / PPTP (None Encryption) OpenVPN (None Encryption)</p>	<p>Throughput Ranking:</p> <p>Very High L2TP / PPTP (None Encryption)</p> <p>High IPsec IKEv2/EAP/IKEv1/XAuth OpenVPN (UDP None Encryption)</p> <p>Medium L2TP over IPsec / PPTP (Encryption) OpenVPN (UDP) OpenVPN (TCP None Encryption)</p> <p>Low SSL/OpenVPN (TCP)</p>
LAN-to-LAN VPN Client Mode Selection:	Route Mode ▾
Select VPN Type:	PPTP (Encryption) ▾
<p>Note:</p> <ol style="list-style-type: none"> 1. Please use Route Mode for typical LAN-to-LAN tunnels. 2. If the remote network is only expecting a single client or IP and is not configured to route the subnet then select NAT Mode. 3. If you are unsure of your configuration select Route Mode. 	

< Back Next > Finish Cancel

Available settings are explained as follows:

Item	Description
LAN-to-LAN Client Mode Selection	<p>Route Mode - All traffic between the local network and the remote network bear the originating IP addresses. Select this if the VPN server can establish routes to handle inter-LAN traffic routing.</p> <p>NAT Mode - The VPN client (local router) uses a single IP address assigned by the VPN server (remote router) and uses NAT to keep track of the connections. Select this if the VPN server expects only one IP address on the local network to communicate with the remote network.</p>
Select VPN Type	Select a VPN protocol for the LAN-to-LAN tunnel. Different VPN protocols offer different levels of security and performance.



Info

The following descriptions for VPN Type are based on the **Route Mode** specified in LAN-to-LAN Client Mode Selection.

If you have selected PPTP (None Encryption) or PPTP (Encryption), the following configuration screen appears.

VPN Client Wizard

VPN Client PPTP Encryption Settings

Profile Name	???
VPN Dial-Out Through	WAN1 First
<input type="checkbox"/> Always on	
Server IP/Host Name for VPN (e.g. draytek.com or 123.45.67.89)	
Username	???
Password	
Remote Network IP	0.0.0.0
Remote Network Mask	255.255.255.0 / 24
Local Network IP	192.168.1.1
Local Network Mask	255.255.255.0 / 24

< Back Next > Finish Cancel

If you have selected IPsec, the following configuration screen appears.

VPN Client Wizard

VPN Client IPsec Settings

Profile Name	???
VPN Dial-Out Through	WAN1 First
<input type="checkbox"/> Always on	
Server IP/Host Name for VPN (e.g. draytek.com or 123.45.67.89)	
IKE Authentication Method	
<input checked="" type="radio"/> Pre-Shared Key	
Confirm Pre-Shared Key	
<input type="radio"/> Digital Signature (X.509)	
Peer ID	None
Local ID	
<input checked="" type="radio"/> Alternative Subject Name First	
<input type="radio"/> Subject Name First	
Local Certificate	None
IPsec Security Method	
<input type="radio"/> Medium (AH)	
<input checked="" type="radio"/> High (ESP)	AES with Authentication
Remote Network IP	0.0.0.0
Remote Network Mask	255.255.255.0 / 24
Local Network IP	192.168.1.1
Local Network Mask	255.255.255.0 / 24

< Back Next > Finish Cancel

If you have selected **SSL/L2TP**, the following configuration screen appears.

VPN Client Wizard

VPN Client L2TP Settings

Profile Name	???
VPN Dial-Out Through	WAN1 First
<input type="checkbox"/> Always on	
Server IP/Host Name for VPN (e.g. draytek.com or 123.45.67.89)	
Username	???
Password	
Remote Network IP	0.0.0.0
Remote Network Mask	255.255.255.0 / 24
Local Network IP	192.168.1.1
Local Network Mask	255.255.255.0 / 24

< Back Next > Finish Cancel

If you have selected **L2TP over IPsec (Nice to Have)** or **L2TP over IPsec (Must)**, the following configuration screen appears.

VPN Client Wizard

VPN Client L2TP over IPsec (Nice to Have) Settings

Profile Name	???
VPN Dial-Out Through	WAN1 First
<input type="checkbox"/> Always on	
Server IP/Host Name for VPN (e.g. draytek.com or 123.45.67.89)	
IKE Authentication Method	
<input checked="" type="radio"/> Pre-Shared Key	
Confirm Pre-Shared Key	
<input type="radio"/> Digital Signature (X.509)	
Peer ID	None
Local ID	
<input checked="" type="radio"/> Alternative Subject Name First	
<input type="radio"/> Subject Name First	
Local Certificate	None
IPsec Security Method	
<input type="radio"/> Medium (AH)	
<input checked="" type="radio"/> High (ESP)	AES with Authentication
Username	???
Password	
Remote Network IP	0.0.0.0
Remote Network Mask	255.255.255.0 / 24
Local Network IP	192.168.1.1
Local Network Mask	255.255.255.0 / 24

< Back Next > Finish Cancel

If you have selected **OpenVPN**, the following configuration screen appears.

VPN Client Wizard

VPN Client OpenVPN Encryption Settings

Profile Name	???
VPN Dial-Out Through	WAN1 First
Import OpenVPN config file	選擇檔案 未選擇任何檔案
<input type="checkbox"/> Always on	
Username	???
Password	Max: 128 characters
Local Network IP	192.168.1.1
Local Network Mask	255.255.255.0 / 24

< Back Next > Finish Cancel

Available settings are explained as follows:

Item	Description
Profile Name	Name that identifies this profile. The maximum length of the Profile Name is 10 characters.
VPN Dial-Out Through	The WAN interface to be used for dialing out to establish the VPN tunnel. WANx First - The Router first attempts to establish the VPN tunnel using this WAN interface. When that is unsuccessful, it will attempt to use other WAN interfaces. WANx Only - The Router will establish the VPN tunnel using this WAN interface only.
Always On	If selected, the router will maintain the VPN connection.
Server IP/Host Name for VPN	Enter the IP address or hostname of the server of the remote VPN server.
IKE Authentication Method	IKE Authentication Method to be used. Choose between Pre-shared Key and Digital Signature (X.509). Pre-shared Key <ul style="list-style-type: none"> ● Pre-Shared Key- Specify a key for IKE authentication. ● Confirm Pre-Shared Key-Confirm the pre-shared key. Digital Signature (X.509) <ul style="list-style-type: none"> ● Peer ID - Select Peer ID from the dropdown list. Peer IDs are managed using VPN and Remote Access >> IPsec Peer Identity. ● Local ID - Select Alternative Subject Name First or Subject Name First. ● Local Certificate - Select a certificate from the dropdown list. Local certificates are managed using Certificate Management >> Local Certificate.
IPsec Security Method	Medium - Authentication Header (AH) means data will be authenticated, but not be encrypted. By default, this option

	is active. High - Encapsulating Security Payload (ESP) means payload (data) will be encrypted and authenticated. You may select encryption algorithm from Data Encryption Standard (DES), Triple DES (3DES), and AES.
Import OpenVPN config file	Select to import an OpenVPN configuration file from a specified OpenVPN server (e.g., Vigor router, PC, other VPN provider and etc.) onto to Vigor router. Later, as a VPN client, this router can access into VPN server via the username and password.
Username	This field is used to authenticate for connection when you select PPTP or L2TP with or without IPsec policy above. The length of the user name is limited to 11 characters.
Password	This field is used to authenticate for connection when you select PPTP or L2TP with or without IPsec policy above. The length of the password is limited to 11 characters.
Remote Network IP	Please enter one LAN IP address (according to the real location of the remote host) for building VPN connection.
Remote Network Mask	Please enter the network mask (according to the real location of the remote host) for building VPN connection.
Local Network IP	Enter the local network IP for TCP / IP configuration.
Local Network Mask	Enter the local network mask for TCP / IP configuration.

- After you have entered all the required information, click **Next** to proceed to the confirmation page. The confirmation page shows a summary of all the settings. If you need to make adjustments to the settings, click **Back** to return to the previous page. Otherwise, select one of the following actions and click **Finish** to save the changes to the LAN-to-LAN VPN profile.

VPN Client Wizard

Please confirm your settings

LAN-to-LAN Index:	1
Profile Name:	Marketing1
VPN Connection Type:	L2TP over IPsec (Nice to Have)
VPN Dial-Out Through:	WAN1 First
Always on:	Yes
Server IP/Host Name:	172.16.3.8
IKE Authentication Method:	Pre-Shared Key
IPsec Security Method:	AES with Authentication
Remote Network IP:	172.16.3.100
Remote Network Mask:	255.255.255.0
Local Network IP:	192.168.1.1
Local Network Mask:	255.255.255.0

Click **Back** to modify changes if necessary. Otherwise,click **Finish** to save the current settings and proceed to the following action:

- Go to the VPN Connection Management.
- Do another VPN Client Wizard setup.
- View more detailed configurations.

Available settings are explained as follows:

Item	Description
Go to the VPN Connection Management	Proceed to VPN and Remote Access>>Connection Management to manage VPN sessions.
Do another VPN Client Wizard Setup	Rerun the VPN Client Wizard to configure another LAN-to-LAN VPN profile.
View more detailed configuration	Open this profile in VPN and Remote Access>>LAN to LAN to make additional configuration changes.

I-10 VPN Server Wizard

The VPN Server Wizard can be used to set the router up as a *server* that accepts inbound VPN connections from a VPN server using a LAN-to-LAN VPN tunnel.

Site-to-Site (LAN-to-LAN)

- A connection between two router's LAN networks.
- Allows employees in branch offices and head office to share the same network resources.

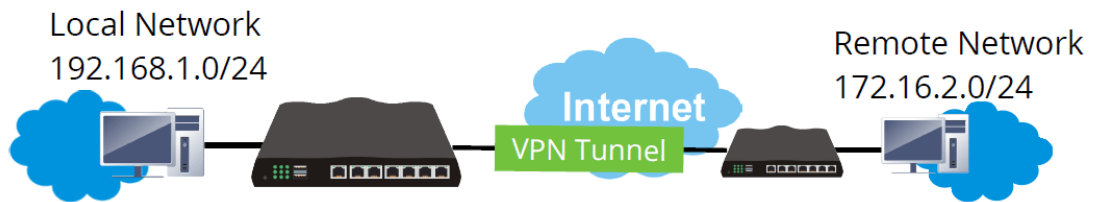

Remote Access (Remote Dial-in)

- A connection between the remote host and router's LAN network. The host will use an IP address in the local subnet.
- Allows employees to access the company's internal resources when they are traveling.

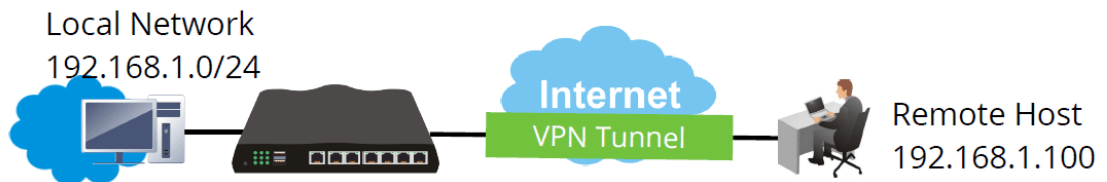

The wizard will guide you step by step through the setup process.

1. On the menu bar, click on **Wizards**, and then **VPN Server Wizard**.

VPN Server Wizard

Choose VPN Establishment Environment

VPN Server Mode Selection: Site to Site VPN (LAN-to-LAN) ▼

Please choose a LAN-to-LAN Profile: [Index] [Status] [Name] ▼

Please choose a Dial-in User Accounts: [Index] [Status] [Name] ▼

Allowed Dial-in Type:

- PPTP
- IPsec
- IPsec XAuth
- L2TP with IPsec Policy None ▼
- SSL Tunnel
- OpenVPN Tunnel

< Back
Next >
Finish
Cancel

Available settings are explained as follows:

Item	Description
VPN Server Mode Selection	Type of VPN Server to be configured. Site to Site VPN (LAN-to-LAN) - Configures the VPN server for inbound connections from other routers. Remote Dial-in User (Teleworker) - Configures VPN server for inbound connections from remote users.
Please choose a LAN-to-LAN Profile	If the VPN Server Mode selected was Site to Site VPN (LAN-to-LAN) , choose a LAN-to-LAN profile to store this configuration.
Please choose a Dial-in User Accounts	If the VPN Server Mode selected was Remote Dial-in User (Teleworker) , choose a Dial-in user profile to store this configuration.
Allowed Dial-in Type	Select all VPN protocols that are allowed for this LAN-to-LAN Profile or Dial-in User Account. Different Dial-in Type will lead to different configuration page. In addition, adjustable items for each dial-in type will be changed according to the VPN Server Mode (Site to Site VPN and Remote Dial-in User) selected.

2. After making the choices for the server profile, please click **Next**.
3. The following dialog box appears, reminding you to not configure IPsec fields if the remote location has a dynamic IP address.

192.168.1.1

If you are using IPsec Main mode and the remote VPN gateway has a dynamic IP address, please don't setup " PeerIP" or "Peer ID" fields, and don't tick "IPsec Authentication". Instead, please go to the VPN and Remote Access >> IPsec General Setup page to setup a common preshared key.

確定

Click OK to dismiss the dialog box and proceed to the next page.

If you have chosen to configure a LAN-to-LAN VPN profile, proceed to step 4.

If you have chosen to configure a Remote Dial-in User VPN profile, proceed to step 5.

4. The Site to Site VPN (LAN-to-LAN) configuration page appears as follows if you have selected PPTP/SSL.

VPN Server Wizard

VPN Authentication Setting

Profile Name	<input data-bbox="986 1084 1251 1115" type="text" value="???"/>
PPTP / SSL Tunnel Authentication	
Username	<input data-bbox="986 1140 1251 1171" type="text" value="???"/>
Password	<input data-bbox="986 1173 1251 1205" type="password"/>
Peer IP/VPN Client IP	<input data-bbox="986 1207 1251 1238" type="text"/>
Site to Site Information	
Remote Network IP	<input data-bbox="986 1263 1251 1294" type="text" value="0.0.0.0"/>
Remote Network Mask	<input data-bbox="986 1296 1195 1328" type="text" value="255.255.255.0 / 24"/>
Local Network IP	<input data-bbox="986 1330 1251 1361" type="text" value="192.168.1.1"/>
Local Network Mask	<input data-bbox="986 1364 1195 1395" type="text" value="255.255.255.0 / 24"/>

< Back

Next >

Finish

Cancel

If you have selected PPTP & IPsec & L2TP (three types) or PPTP & IPsec (two types) or L2TP with Policy (Nice to Have/Must), the following configuration screen appears.

VPN Server Wizard

VPN Authentication Setting

Profile Name	???
PPTP / IPsec / L2TP with IPsec Authentication	
Username	???
Password	
<input checked="" type="checkbox"/> Pre-Shared Key	
Confirm Pre-Shared Key	
<input type="checkbox"/> Digital Signature (X.509)	
Peer ID	None
Local ID	
<input checked="" type="radio"/> Alternative Subject Name First	
<input type="radio"/> Subject Name First	
Peer IP/VPN Client IP	
Peer ID	
Site to Site Information	
Remote Network IP	0.0.0.0
Remote Network Mask	255.255.255.0 / 24
Local Network IP	192.168.1.1
Local Network Mask	255.255.255.0 / 24

< Back Next > Finish Cancel

If you have selected IPsec, the following configuration screen appears.

VPN Server Wizard

VPN Authentication Setting

Profile Name	???
IPsec Authentication	
<input checked="" type="checkbox"/> Pre-Shared Key	
Confirm Pre-Shared Key	
<input type="checkbox"/> Digital Signature (X.509)	
Peer ID	None
Local ID	
<input checked="" type="radio"/> Alternative Subject Name First	
<input type="radio"/> Subject Name First	
Peer IP/VPN Client IP	
Peer ID	
Site to Site Information	
Remote Network IP	0.0.0.0
Remote Network Mask	255.255.255.0 / 24
Local Network IP	192.168.1.1
Local Network Mask	255.255.255.0 / 24

< Back Next > Finish Cancel

If you have selected **OpenVPN**, the following configuration screen appears.

VPN Server Wizard

VPN Authentication Setting

Profile Name	???
OpenVPN Tunnel Authentication	
Username	???
Password	Max: 128 characters
Peer IP/VPN Client IP	
Site to Site Information	
Remote Network IP	0.0.0.0
Remote Network Mask	255.255.255.0 / 24
Local Network IP	192.168.1.1
Local Network Mask	255.255.255.0 / 24

OpenVPN General Setup

Certificates Setup

Generated certificates	Root Certificate:	None
	Server Certificate:	None
	Client Certificate:	None
	Trust Certificate:	None

Note:
 OpenVPN authentication is based on certificates.
 You may either generate new (by clicking "Generate" button) or upload existing certificates to the following path:

1. Upload Server Certificate to [Certificate Management >> Local Certificate](#).
2. Upload Trusted Certificate to [Certificate Management >> Trusted CA Certificate](#).

Available settings are explained as follows:

Item	Description
Profile Name	Name to identify this VPN profile.
User Name	Used by the remote LAN to establish a VPN connection. The length of the user name is limited to 11 characters.
Password	Used by the remote LAN to establish a VPN connection. The length of the password is limited to 11 characters.
IPsec / IPsec XAuth / L2TP with IPsec / SSL Tunnel Authentication	
Pre-Shared Key	<p>For PPTP / IPsec / IPsec XAuth / L2TP with IPsec / SSL Tunnel authentication, you have to configure a pre-shared key and/or digital signature.</p> <p>Note that, if the remote client has a dynamic IP address, do not enable any of the settings (PSK / Digital Signature) in this section. Instead, configure the global IPsec settings by using VPN and Remote Access>>IPsec General Setup.</p> <p>Pre-Shared Key - Select to enter an IPsec Pre-shared Key specific to this profile. The length of the PSK is limited to 64</p>

	<p>characters.</p> <p>Confirm Pre-Shared Key - Re-enter the Pre-shared Key again to confirm.</p>
Digital Signature (X.509)	<p>Digital Signature (X.509) - Select to enable X.509 digital signature.</p> <p>Peer ID - Select a predefined X.509 digital signature as the Peer ID. Peer IDs must be configured first using VPN and Remote Access>>IPsec Peer Identity.</p> <p>Local ID - Specifies whether the Subject Name or the Alternative Subject Name of the X.509 Peer ID is to be checked first. Select either Alternative Subject Name First or Subject Name First.</p>
Peer IP/VPN Client IP	<p>Enter the WAN IP address or VPN client IP address for the remote client.</p> <p>If values are specified, only connections coming from the specified IP address and/or having the specified Peer ID will be accepted.</p>
Peer ID	<p>Enter the ID name for the remote client.</p> <p>The maximum length of the peer ID is 47 characters.</p> <p>If the values are specified, only connections coming from the specified IP address and/or having the specified Peer ID will be accepted.</p>
Site to Site Information	
Remote Network IP	Enter the IP address of the remote network.
Remote Network Mask	Enter the subnet mask of the remote network.
Local Network IP	Enter the local network IP for TCP / IP configuration.
Local Network Mask	Enter the local network mask for TCP / IP configuration.
OpenVPN General Setup	Generate - Click to generate certificate for OpenVPN authentication. Or upload an existing certificate from Local Certificate or Trusted CA Certificate page.

5. The Remote Dial-in User (Teleworker) VPN configuration page appears as follows if you have selected PPTP/SSL.

VPN Server Wizard

VPN Authentication Setting

PPTP / SSL Tunnel Authentication	
Username	???
Password	Max: 128 characters
Peer IP/VPN Client IP	
Subnet	LAN 1 ▾

< Back Next > Finish Cancel

If you have selected IPsec XAuth/L2TP with IPsec Policy (None), the following configuration screen appears.

VPN Server Wizard

VPN Authentication Setting

IPsec XAuth / L2TP with IPsec Authentication	
Username	???
Password	Max: 128 characters
<input checked="" type="checkbox"/> Pre-Shared Key	
Confirm Pre-Shared Key	
Peer IP/VPN Client IP	
Peer ID	
Subnet	LAN 1 ▾

< Back Next > Finish Cancel

If you have selected **IPsec XAuth/L2TP with IPsec Policy (Nice to Have)/L2TP with IPsec Policy (Must)**, the following configuration screen appears.

VPN Server Wizard

VPN Authentication Setting

IPsec XAuth / L2TP with IPsec Authentication

Username

Password

Pre-Shared Key

Confirm Pre-Shared Key

Digital Signature (X.509)

Peer ID

Peer IP/VPN Client IP

Peer ID

Subnet

If you have selected **OpenVPN Tunnel**, the following configuration screen appears.

VPN Server Wizard

VPN Authentication Setting

OpenVPN Tunnel Authentication

Username

Password

Peer IP/VPN Client IP

Subnet

OpenVPN General Setup

Certificates Setup

Generated certificates

Root Certificate:	None
Server Certificate:	None
Client Certificate:	None
Trust Certificate:	None

Note:
 OpenVPN authentication is based on certificates.
 You may either generate new (by clicking "Generate" button) or upload existing certificates to the following path:

1. Upload Server Certificate to [Certificate Management >> Local Certificate](#).
2. Upload Trusted Certificate to [Certificate Management >> Trusted CA Certificate](#).

Available settings are explained as follows:

Item	Description
User Name	Used by the remote LAN to establish a VPN connection. The length of the user name is limited to 11 characters.
Password	Used by the remote LAN to establish a VPN connection. The length of the password is limited to 11 characters.
IKEv1/IKEv2 / IPsec XAuth / L2TP with IPsec /SSL Tunnel Authentication	
Pre-Shared Key	For IKEv1/IKEv2 / IPsec / IPsec XAuth / L2TP with IPsec / SSL Tunnel authentication, you have to configure a pre-shared key and/or digital signature. Note that, if the remote client has a dynamic IP address, do not enable any of the settings (PSK / Digital Signature) in this section. Instead, configure the global IPsec settings by using VPN and Remote Access>>IPsec General Setup. Pre-Shared Key - Select to enter an IPsec Pre-shared Key specific to this profile. The length of the PSK is limited to 64 characters. Confirm Pre-Shared Key - Re-enter the Pre-shared Key again to confirm.
Digital Signature (X.509)	Digital Signature (X.509) - Select to enable X.509 digital signature. Peer ID - Select a predefined X.509 digital signature as the Peer ID. Peer IDs must be configured first using VPN and Remote Access>>IPsec Peer Identity.
Peer IP/VPN Client IP	Enter the WAN IP address or VPN client IP address for the remote client. If values are specified, only connections coming from the specified IP address and/or having the specified Peer ID will be accepted.
Peer ID	Enter the ID name for the remote client. The maximum length of the peer ID is 47 characters. If the values are specified, only connections coming from the specified IP address and/or having the specified Peer ID will be accepted.
Subnet	Select an interface.
OpenVPN General Setup	Generate - Click to generate certificate for OpenVPN authentication. Or upload existing certificates from Local Certificate or Trusted CA Certificate page.

6. After finishing the configuration, click **Next** to proceed to the confirmation page.

VPN Server Wizard

Please Confirm Your Settings

VPN Environment:	Site to Site VPN (LAN-to-LAN)
Index:	1
Profile Name:	test
Username:	ppendss
Allowed Service:	IPsec XAuth+L2TP+L2TP with IPsec Policy
Peer IP/VPN Client IP:	172.16.3.99
Peer ID:	testfor
Remote Network IP:	172.16.3.190
Remote Network Mask:	255.255.255.0
Local Network IP:	192.168.1.1
Local Network Mask:	255.255.255.0

Click **Back** to modify changes if necessary. Otherwise, click **Finish** to save the current settings and proceed to the following action:

Go to the VPN Connection Management.
 Do another VPN Server Wizard setup.
 View more detailed configurations.

Available settings are explained as follows:

Item	Description
Go to the VPN Connection Management	Proceed to VPN and Remote Access>>Connection Management to manage VPN sessions.
Do another VPN Server Wizard Setup	Rerun the VPN Server Wizard to configure another LAN-to-LAN VPN profile.
View more detailed configuration	Open this profile in VPN and Remote Access>>LAN to LAN to make additional configuration changes.

7. Click **Finish** to save the profile, or **Back** to make changes, or **Cancel** to exit the wizard without saving.

Part II Connectivity



WAN

It means wide area network. Public IP will be used in WAN.



LAN

It means local area network. Private IP will be used in LAN.

Local Area Network (LAN) is a group of subnets regulated and ruled by router. The design of network structure is related to what type of public IP addresses coming from your ISP.



NAT

When the data flow passing through, the Network Address Translation (NAT) function of the router will dedicate to translate public/private addresses, and the packets will be delivered to the correct host PC in the local area network.



Applications

DNS, LAN DNS, IGMP, WOL, RADIUS, ...



Routing

Static Route, Load-Balance/Route Policy, OSPF, BGP

II-1 Port Setup

This page is used for configuring transmission rate for LAN and WAN ports respectively.

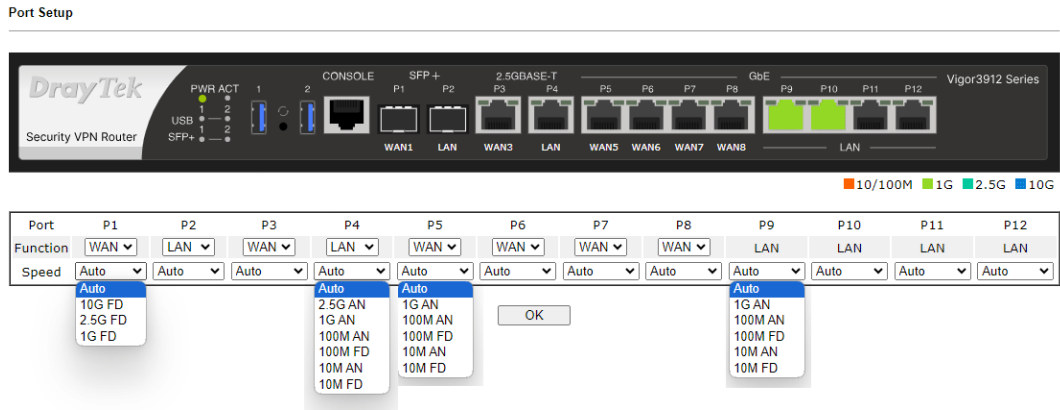

Available settings are explained as follows:

Item	Description
Port	Display the physical ports on Vigor router.
Function	P1 ~ P8 - These ports are switchable between WAN and LAN ports.
Speed	P1 ~ P2 - Available options include Auto, 10G FD, 2.5G FD and 1G FD. P3 ~ P4 - Available options include Auto, 2.5G AN, 1G AN, 100M AN, 100M FD, 10M AN and 10M FD. P5 ~ P12- Available options include Auto, 1G AN, 100M AN, 100M FD, 10M AN and 10M FD.

II-2 WAN

It allows users to access Internet.

Basics of Internet Protocol (IP) Network

IP means Internet Protocol. Every device in an IP-based Network including routers, print server, and host PCs, needs an IP address to identify its location on the network. To avoid address conflicts, IP addresses are publicly registered with the Network Information Centre (NIC). Having a unique IP address is mandatory for those devices participated in the public network but not in the private TCP/IP local area networks (LANs), such as host PCs under the management of a router since they do not need to be accessed by the public. Hence, the NIC has reserved certain addresses that will never be registered publicly. These are known as *private* IP addresses, and are listed in the following ranges:

From 10.0.0.0 to 10.255.255.255

From 172.16.0.0 to 172.31.255.255

From 192.168.0.0 to 192.168.255.255

What are Public IP Address and Private IP Address

As the router plays a role to manage and further protect its LAN, it interconnects groups of host PCs. Each of them has a private IP address assigned by the built-in DHCP server of the Vigor router. The router itself will also use the default **private IP** address: 192.168.1.1 to communicate with the local hosts. Meanwhile, Vigor router will communicate with other network devices through a **public IP** address. When the data flow passing through, the Network Address Translation (NAT) function of the router will dedicate to translate public/private addresses, and the packets will be delivered to the correct host PC in the local area network. Thus, all the host PCs can share a common Internet connection.

Get Your Public IP Address from ISP

In ADSL deployment, the PPP (Point to Point)-style authentication and authorization is required for bridging customer premises equipment (CPE). Point to Point Protocol over Ethernet (PPPoE) connects a network of hosts via an access device to a remote access concentrator or aggregation concentrator. This implementation provides users with significant ease of use. Meanwhile it provides access control, billing, and type of service according to user requirement.

When a router begins to connect to your ISP, a serial of discovery process will occur to ask for a connection. Then a session will be created. Your user ID and password is authenticated via **PAP** or **CHAP** with **RADIUS** authentication system. And your IP address, DNS server, and other related information will usually be assigned by your ISP.

Web User Interface

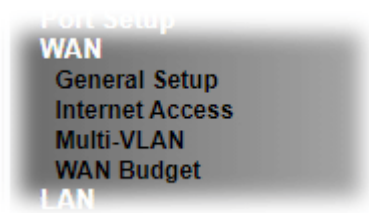

II-2-1 General Setup

This section will introduce some general settings of Internet and explain the connection modes for WAN1-WAN8 in details.

This router supports multiple-WAN function. It allows users to access Internet and combine the bandwidth of the multiple WANs to speed up the transmission through the network. Each WAN port can connect to different ISPs, Even if the ISPs use different technology to provide telecommunication service (such as DSL, Cable modem, etc.). If any connection problem occurred on one of the ISP connections, all the traffic will be guided and switched to the normal communication port for proper operation. Please configure WAN# settings.

This webpage allows you to set general setup for WAN# respectively.

WAN >> General Setup

Index	Enable	Physical Mode/Type	Bandwidth(Kbps) DownLink/UpLink	Latency	Jitter	Pkt.Loss	Active Mode	Load Balance
WAN1	<input checked="" type="checkbox"/>	Fiber/Auto negotiation / P1	- / -	-	-	-	Always On	<input checked="" type="checkbox"/>
WAN3	<input checked="" type="checkbox"/>	Ethernet/Auto negotiation / P3	4 / 28	18.2 ms	1.8 ms	0%	Always On	<input checked="" type="checkbox"/>
WAN5	<input checked="" type="checkbox"/>	Ethernet/Auto negotiation / P5	- / -	-	-	-	Always On	<input checked="" type="checkbox"/>
WAN6	<input checked="" type="checkbox"/>	Ethernet/Auto negotiation / P6	- / -	-	-	-	Always On	<input checked="" type="checkbox"/>
WAN7	<input checked="" type="checkbox"/>	Ethernet/Auto negotiation / P7	- / -	-	-	-	Always On	<input checked="" type="checkbox"/>
WAN8	<input checked="" type="checkbox"/>	Ethernet/Auto negotiation / P8	- / -	-	-	-	Always On	<input checked="" type="checkbox"/>

Load Balance Setup

Advanced

Mode	<input type="text" value="IP Based"/>
Line Speed	<input type="text" value="Auto Detect"/>
Load Balance Weights	<input type="text" value="Bandwidth-Based"/>

Note:

Latency,jitter,and packet-loss require setting Link Condition Detection in each WAN setting page.

Available settings are explained as follows:

Item	Description
Index (WAN1 ~WAN8)	Click the WAN interface link under Index to access into the WAN configuration page.
Enable	Check the box to enable this WAN interface.
Physical Mode / Type	Display the physical mode, physical type, and LAN port of this WAN interface.
Line Speed(Kbps) DownLink/UpLink	Display the downstream and upstream rate of this WAN interface.
Active Mode	Display whether this WAN interface is Active device or backup device. Always On - WAN is always enabled.

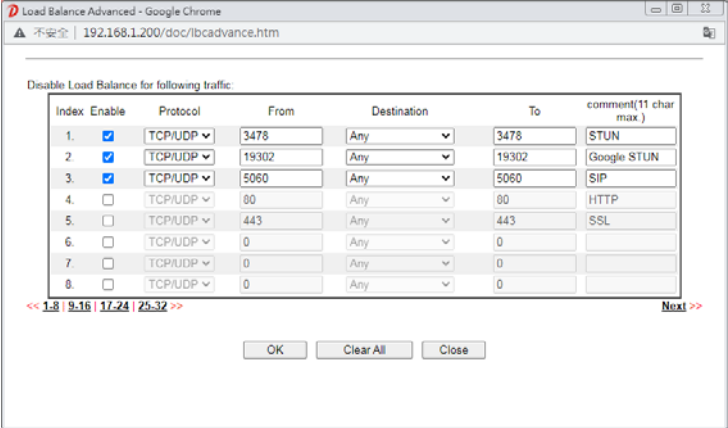
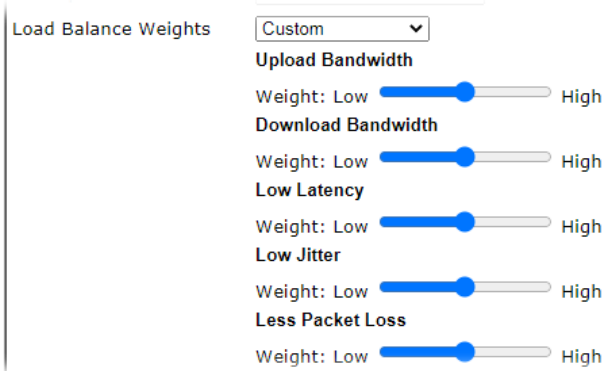
	<p>Backup (WAN#)- Display the backup WAN interface for this WAN when it is disabled.</p>
<p>Load Balance</p>	<p>V means the function of load balance for such WAN interface is enabled.</p>
<p>Load Balance Setup</p>	<p>Advanced - Load Balance for the traffic of STUN, google STUN, and SIP are disabled in default to prevent from conflict. The following dialog allows you to define protocol, port and name for the traffic not to be applied with load balance. That is, when an item is enabled (checked), it might not be affected by load balance.</p> 
<p>Mode</p>	<p>IP Based - The same source / destination IP pair will select the same WAN interface as policy. It is the default setting.</p> <p>Session Based- All of the WAN interfaces will be used (as out-going WAN) for passing through new sessions to get better transmission speed. Though good speed test result for throughput might be reached; however, some web site may not open smoothly, especially the site need authentication, e.g., FTP.</p> <p>If you have no strong demand about speed test result, keep default settings as IP based.</p>
<p>Line Speed</p>	<p>This option is available for multiple-WAN for getting enough bandwidth for each WAN port. If you know the practical bandwidth for your WAN interface, please choose the setting of According to Line Speed. Otherwise, please choose Auto Detect to let the router reach the best load balance.</p>
<p>Load Balance Weights</p>	<p>There are four weight types for choosing to meet your request.</p> <p>Custom - You can distribute the usage ratio for each WAN interface by setting weights for bandwidth, latency, jitter, and packet loss respectively.</p> 

- **Upload / Download Bandwidth** - The higher the weight is, the WAN interface with higher bandwidth will get higher usage.
- **Low Latency** - It defines the time taken by Vigor router when sending the packets to the IP set in Link Condition Detection. The higher the weight is, the WAN interface with lower latency will get higher usage.
- **Low Jitter** - It defines the change rate of latency. For stable session, small jitter value will be better. The higher the weight is, the WAN interface with lower jitter will get higher usage.
- **Less Packet Loss** - It defines the proportion that packets will be discarded before arriving at the IP set in Link Condition Detection. The higher the weight is, the WAN interface with lower packet loss will get higher usage.

Bandwidth-Based - The load balance weight for each WAN will be executed according to line speed setting (DownLink/UpLink Rate). This is default setting.

Quality-Based - The load balance weight for each WAN will be executed according to the transmission rate, latency time and the jitter time.

Reliability-Based - The load balance weight for each WAN will be executed according to line speed and packet loss value. Usually, the WAN interface with low packet loss will have the higher ratio to be used.



Info

In default, each WAN port is enabled.

After finished the above settings, click OK to save the settings.

To configure WAN interface settings, click the WAN# link to open the following page.

WAN 3

Enable:	<input type="button" value="Yes"/>
Display Name:	<input type="text"/>
Physical Mode:	Ethernet
Physical Type(Ethernet):	Auto negotiation
Line Speed(Kbps):	
DownLink	<input type="text" value="0"/>
UpLink	<input type="text" value="0"/>
VLAN Tag insertion :	Disable
Tag value:	<input type="text" value="0"/> (0~4095)
Priority:	<input type="text" value="0"/> (0~7)
Link Condition Detection Mode	Ping Detect
Primary Ping IP	<input type="text" value="8.8.8.8"/>
Secondary Ping IP	<input type="text" value="8.8.4.4"/>
Ping Interval	<input type="text" value="10"/> Seconds(s)
Active Mode:	Backup
Backup For	<input type="checkbox"/> WAN 1 <input type="checkbox"/> WAN 3 <input type="checkbox"/> WAN 5 <input type="checkbox"/> WAN 6 <input type="checkbox"/> WAN 7 <input type="checkbox"/> WAN 8
Active When	Any of the WAN selected above
	<input type="radio"/> Fails to connect: <input checked="" type="radio"/> Meet Any of the following conditions: <ul style="list-style-type: none"> <input type="checkbox"/> Upload traffic reaches <input type="text" value="0"/> Kbps <input type="checkbox"/> Download traffic reaches <input type="text" value="0"/> Kbps <input type="checkbox"/> Latency over <input type="text" value="0"/> ms <input type="checkbox"/> Jitter over <input type="text" value="0"/> ms <input type="checkbox"/> Packet loss over <input type="text" value="0"/> %

Note:

The line speed setting of WAN interface is available only when According to Line Speed is selected as the Load Balance Mode.

OK

Cancel

Available settings are explained as follows:

Item	Description
Enable	Choose Yes to invoke the settings for this WAN interface. Choose No to disable the settings for this WAN interface.
Display Name	Type the description for such WAN interface.
Physical Mode	Display the physical mode of such WAN interface.
Physical Type	You can change the physical type for WAN or choose Auto negotiation for determined by the system.
Line Speed	If you choose According to Line Speed as the Load Balance Mode, please type the line speed for downloading and uploading for such WAN interface. The unit is kbps.
VLAN Tag insertion	Such feature is offered to the user with the environment supporting IEEE_802.1ad. In which, service is used for outer tag; customer is used for inner tag. It is available only when Ethernet is selected as Physical Mode. Disable - Disable the function of VLAN with tag. Enable - Enable the function of VLAN with tag. The router will add specific VLAN number to all packets on the WAN while sending them out. Please Enter the tag value and specify the priority for the

	<p>packets sending by WAN1.</p> <ul style="list-style-type: none"> ● Tag value - Enter the value as the VLAN ID number. The range is form 0 to 4095. ● Priority - Enter the packet priority number for such VLAN. The range is from 0 to 7.
Link Condition Detection	<p>In order for the system to detect the latency, jitter, and packet-loss status for each WAN interface, you have to specify the IP transmitting data through the interface.</p> <p>Mode - Choose Ping Detect, Http Detect, or Disable as detection mode. If Ping Detect or Http Detect is selected, you have to configure the following option.</p> <ul style="list-style-type: none"> ● Primary Ping IP - Enter an IP address. ● Secondary Ping IP - Enter an IP address. ● Ping Interval - Set a time interval (unit:second) for the system to ping the IP address specified above.
Active Mode	<p>Always On - Choose Always On to make this WAN connection being activated always.</p> <p>Backup - Choose it to make this WAN connection as a backup connection.</p> <p>Backup For - Specify the WAN interface by checking the WAN box. This WAN will be the backup WAN for the selected WAN interface(s).</p> <p>Active When - Set the condition for backup connection.</p> <p>Any/All - This WAN will be activated when any/all master WAN interface(s),</p> <ul style="list-style-type: none"> ● Fails to connect ● Meet All/Any of the following conditions - When the upload traffic, download traffic, latency, jitter and/or packet loss of active WAN reaches the traffic threshold (specified here), the backup WAN will be enabled automatically to share the overloaded data traffic.

After finished the above settings, click OK to save the settings.

II-2-2 Internet Access

For the router supports multi-WAN function, the users can set different WAN settings for Internet Access. Due to different Physical Mode for WAN interface, the Access Mode for these connections also varies. Refer to the following figures.

WAN >> Internet Access

Internet Access					
Index	Display Name	Physical Mode / Port	Access Mode	Details Page	IPv6
WAN1		Fiber / P1	Static or Dynamic IP	Details Page	IPv6
WAN3		Ethernet / P3	PPPoE	Details Page	IPv6
WAN5		Ethernet / P5	Static or Dynamic IP	Details Page	IPv6
WAN6		Ethernet / P6	Static or Dynamic IP	Details Page	IPv6
WAN7		Ethernet / P7	Static or Dynamic IP	Details Page	IPv6
WAN8		Ethernet / P8	Static or Dynamic IP	Details Page	IPv6

DHCP Client Option

Available settings are explained as follows:

Item	Description
Index	Display the WAN interface.
Display Name	It shows the name of the WAN1 ~ WAN8 that entered in general setup.
Physical Mode / Port	It shows the physical connection for WAN(Ethernet) /port number according to the real network connection.
Access Mode	Use the drop down list to choose a proper access mode. The details page of that mode will be popped up. If not, click Details Page for accessing the page to configure the settings.
Details Page	This button will open different web page (based on IPv4) according to the access mode that you choose in WAN interface. Note that Details Page will be changed slightly based on physical mode.
IPv6	This button will open different web page (based on Physical Mode) to setup IPv6 Internet Access Mode for WAN interface. If IPv6 service is active on this WAN interface, the color of "IPv6" will become green.
DHCP Client Option	This button allows you to configure DHCP client options. DHCP packets can be processed by adding option number and data information when such function is enabled and configured.

WAN >> Internet Access

DHCP Client Options Status 5 entries per page

Options List	Interface	Option	Type	Data
<input checked="" type="checkbox"/> Enable <input type="checkbox"/> All <input checked="" type="checkbox"/> WAN1 <input type="checkbox"/> WAN3 <input type="checkbox"/> WAN5 <input type="checkbox"/> WAN6 <input type="checkbox"/> WAN7 <input type="checkbox"/> WAN8 <input type="checkbox"/> WAN13 <input type="checkbox"/> WAN14 <input type="checkbox"/> WAN15 <input type="checkbox"/> WAN16 <input type="checkbox"/> WAN17 <input type="checkbox"/> WAN18 <input type="checkbox"/> WAN19 <input type="checkbox"/> WAN20 <input type="checkbox"/> WAN21 <input type="checkbox"/> WAN22 <input type="checkbox"/> WAN23 <input type="checkbox"/> WAN24 <input type="checkbox"/> WAN25 <input type="checkbox"/> WAN26 <input type="checkbox"/> WAN27 <input type="checkbox"/> WAN28 <input type="checkbox"/> WAN29 <input type="checkbox"/> WAN30 <input type="checkbox"/> WAN31 <input type="checkbox"/> WAN32 <input type="checkbox"/> WAN33 <input type="checkbox"/> WAN34 <input type="checkbox"/> WAN35 <input type="checkbox"/> WAN36 <input type="checkbox"/> WAN37 <input type="checkbox"/> WAN38 <input type="checkbox"/> WAN39 <input type="checkbox"/> WAN40 <input type="checkbox"/> WAN41 <input type="checkbox"/> WAN42 <input type="checkbox"/> WAN43 <input type="checkbox"/> WAN44 <input type="checkbox"/> WAN45 <input type="checkbox"/> WAN46 <input type="checkbox"/> WAN47 <input type="checkbox"/> WAN48 <input type="checkbox"/> WAN49 <input type="checkbox"/> WAN50 <input type="checkbox"/> WAN51 <input type="checkbox"/> WAN52				

Option Number:

Data Type:

 ASCII Character (Ex: Option:18, Data:/path)

 Hexadecimal Digit (Please check note 4.)

 Address List (Ex: Option:44, Data:172.16.2.10,172.16.2.20...)

Data:

Note:

- Option 12 is reserved. You cannot configure it here, but you can configure it in "Router Name" field of "WAN >> Internet Access >> Details Page".
- Option 55 is reserved and configured with value 1, 3, 6, 15 and 212, also 33 and 121 for some models.
- Configuring option 61 here will override the setting in "WAN >> Internet Access" page's DHCP Client Identifier field.
- Hexadecimal Digit: Input the hexadecimal representation of ASCII Character data. Ex: Option:18, Data:2F70C1F468 (/path)

Enable - Check the box to enable the function of DHCP Option. Each DHCP option is composed by an option number with data. For example,

Option number: 100

Data: abcd

When such function is enabled, the specified values for DHCP option will be seen in DHCP reply packets.

Interface - Specify the WAN interface(s) that will be overwritten by this function. WAN13 ~ WAN52 can be located under **WAN>>Multi-VLAN**.

Option Number - Type a number for such function.

Data Type - Choose the type (ASCII or Hex) for the data to be stored.

Data - Type the content of the data to be processed by the function of DHCP option.



Info

If you choose to configure option 61 here, the detailed settings in **WAN>>Interface Access** will be overwritten.

II-2-2-1 Details Page for PPPoE

To choose PPPoE as the accessing protocol of the Internet, please select **PPPoE** from the **WAN>>Internet Access >>WAN3** page. The following web page will be shown.

WAN >> Internet Access

WAN 1

PPPoE	Static or Dynamic IP	IPv6
<input type="radio"/> Enable <input checked="" type="radio"/> Disable		
ISP Access Setup Username <input type="text" value="Max: 63 characters"/> Password <input type="text" value="Max: 62 characters"/> More Options		
WAN Connection Detection Mode <input type="text" value="PPP Detect"/>		
MTU <input type="text" value="1492"/> (Max: 1492) <input type="button" value="Path MTU Discovery"/>		
PPP/MP Setup PPP Authentication <input type="text" value="PAP/CHAP/MS-CHAP/MS-CHAPv2"/> Idle Timeout <input type="text" value="-1"/> second(s) IP Assignment (IPCP) <input type="radio"/> Static <input checked="" type="radio"/> Dynamic Fixed IP Address <input type="text"/> <input type="button" value="WAN IP Alias"/>		
Dial-Out Schedule Index(1-15) in Schedule Setup : <input type="text" value="None"/> => <input type="text" value="None"/> => <input type="text" value="None"/> => <input type="text" value="None"/>		
TTL <input checked="" type="checkbox"/> Change the TTL value <input checked="" type="radio"/> Default MAC Address <input type="radio"/> Specify a MAC Address <input type="text" value="00 : 1D : AA : 9C : D3 : F1"/>		

Note:

VPN feature may be affected when the value of MTU is changed, please also check your value of VPN MSS in [VPN and Remote Access >> PPP General Setup](#) or [VPN and Remote Access >> IPsec General Setup](#) page. We recommend to put the same decreased value on VPN MSS. For example, reducing the MTU from 1500 -> 1400, then it will need to reduce 100 from MSS value.

Available settings are explained as follows:

Item	Description
Enable/Disable	Enable or disable PPPoE access mode.
ISP Access Setup	Enter your allocated username, password and authentication parameters according to the information provided by your ISP. Username - Username provided by the ISP for PPPoE authentication. Password - Password provided by the ISP for PPPoE authentication. More Options - <ul style="list-style-type: none"> ● Service Name (Optional) - Sets the PPP service name tag. Required by some ISPs. Leave blank unless instructed otherwise by your ISP.
WAN Connection Detection	Configures how the WAN connection is monitored. Mode - Choose ARP Detect or Ping Detect for the system to execute for WAN detection. <ul style="list-style-type: none"> ● ARP Detect - The router broadcasts an ARP request every 5 seconds. If no response is received within 30 seconds, the WAN connection is deemed to have failed. ● Ping Detect - The router sends an ICMP (Internet Control Message Protocol) echo request every second to the host, whose address is specified in the Ping IP field, to verify the WAN connection. If the remote host does not respond within 30 seconds, the WAN connection is

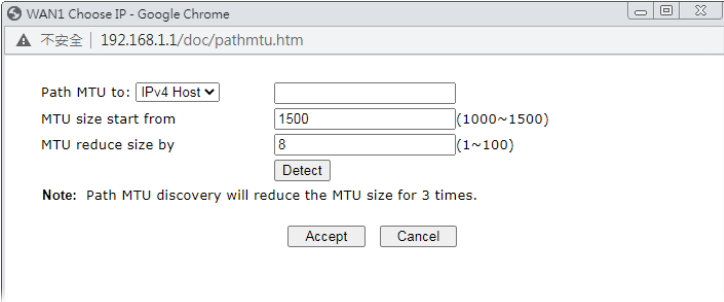
	<p>deemed to have failed.</p> <p>If you choose Ping Detect as the detection mode, you have to enter required settings for the following items.</p> <ul style="list-style-type: none"> ● Primary/Secondary Ping IP - Enter Primary or Secondary IP address in this field for pinging. ● Ping Gateway IP - Enable this setting to use current WAN gateway IP address for pinging. ● With the IP address(es) pinging, Vigor router can check if the WAN connection is on or off. ● TTL (Time to Live) - Time To Live, the maximum allowed number of hops to the ping destination. Valid values range from 1 to 255. ● Ping Interval - Enter the interval for the system to execute the PING operation. ● Ping Retry - Enter the number of times that the system is allowed to execute the PING operation before WAN disconnection is judged.
<p>MTU</p>	<p>Maximum Transmission Unit, the size of the largest packet, in bytes, that can be transmitted to the WAN. The maximum value is 1500. For PPPoE connections, there is always an 8-byte overhead, so the maximum valid MTU value for PPPoE is 1492.</p> <p>Path MTU Discovery - Use this feature to determine the optimal MTU size for the WAN.</p> <p>Click Path MTU Discovery to open the following dialog.</p>  <ul style="list-style-type: none"> ● Path MTU to - Select Host / IP, for an IPv4 address or Host / IPv6, for an IPv6 address, and then enter the IP address in the textbox. ● MTU size start from - Determine the starting point value of the packet. ● MTU reduce size by - Number of octets by which to decrease the 1500-byte MTU. Start with a 0 value for the reduce size and click the Detect button. If the message Fail is returned, increase the MTU reduce size and try again. Repeat until you see the message Success, indicating that the optimal MTU size has been reached. ● Detect - Click it to detect a suitable MTU value. ● Accept - After clicking it, the detected value will be displayed in the field of MTU.
<p>PPP/MP Setup</p>	<p>PPP Authentication - The protocol used for PPP authentication.</p> <ul style="list-style-type: none"> ● PAP only - Only PAP (Password Authentication Protocol)

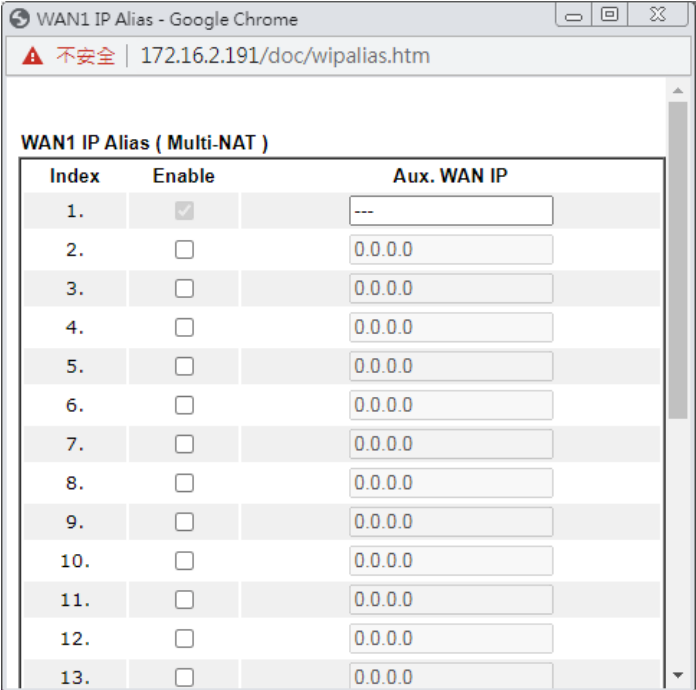
	<p>is used.</p> <ul style="list-style-type: none"> ● PAP/CHAP/MS-CHAP/MS-CHAPv2 - Both PAP and CHAP (Challenge-Handshake Authentication Protocol) can be used for PPP authentication. Router negotiates with the PPTP or L2TP server to determine which protocol to use. <p>Idle Timeout - Set the timeout for breaking down the Internet after passing through the time without any action.</p> <p>Assignment (IPCP) - Configure the router according to how your ISP allocates WAN IP address(es) to you.</p> <ul style="list-style-type: none"> ● Static - ISP has assigned a fixed WAN IP address, which is to be entered below in Fixed IP Address. ● Dynamic - WAN IP address is dynamically allocated. <p>Fixed IP Address - Enter a fixed IP address.</p> <p>WAN IP Alias - Click to enter multiple WAN IP addresses assigned by your ISP.</p> 
<p>Dial-Out Schedule</p>	<p>Specify up to 4 time schedule entries to enable or disable the WAN. All the schedules can be set previously in Applications >> Schedule web page and you can use the number that you have set in that web page.</p>
<p>TTL</p>	<p>Change the TTL value - Enable or disable the TTL (Time to Live) for a packet transmitted through Vigor router.</p> <ul style="list-style-type: none"> ● If enabled - TTL value will be reduced (-1) when it passes through Vigor router. It will cause the client, accessing Internet through Vigor router, to be blocked by certain ISP when TTL value becomes "0". ● If disabled - TTL value will not be reduced. Then, when a packet passes through Vigor router, it will not be cancelled. That is, the client who sends out the packet will not be blocked by ISP.
<p>MAC</p>	<p>Default MAC Address - Use the default MAC address for the</p>

	<p>WAN Ethernet port.</p> <p>Specify a MAC Address - Specify a MAC address for the WAN Ethernet port. Select this option if your ISP authenticates by MAC addresses.</p>
--	---

After finishing all the settings here, please click **OK** to activate them.

II-2-2-2 Details Page for Static or Dynamic IP

For static IP mode, you usually receive a fixed public IP address or a public subnet, namely multiple public IP addresses from your DSL or Cable ISP service providers. In most cases, a Cable service provider will offer a fixed public IP, while a DSL service provider will offer a public subnet. If you have a public subnet, you could assign an IP address or many IP address to the WAN interface.

To use **Static or Dynamic IP** as the accessing protocol of the internet, please click the **Static** or **Dynamic IP** tab. The following web page will be shown.

WAN >> Internet Access

WAN 3

PPPoE
 Static or Dynamic IP
 IPv6

Enable **Disable**

IP Network Settings

Obtain an IP address automatically
 More Options

Specify an IP address

IP Address
 Subnet Mask
 Gateway IP Address

DNS Server IP Address

Primary Server
 Secondary Server

WAN Connection Detection

Mode

MTU

Keep WAN Connection

Enable PING to keep alive
 PING to the IP
 PING Interval minute(s)

TTL

Change the TTL value

RIP Routing

Enable RIP

MAC Address

Default MAC Address
 Use the following MAC Address

Note:

VPN feature may be affected when the value of MTU is changed, please also check your value of VPN MSS in [VPN and Remote Access >> PPP General Setup](#) or [VPN and Remote Access >> IPsec General Setup](#) page. We recommend to put the same decreased value on VPN MSS. For example, reducing the MTU from 1500 -> 1400, then it will need to reduce 100 from MSS value.

Available settings are explained as follows:

Item	Description
Enable/Disable	Enable or disable Static or Dynamic IP access mode.
IP Network Settings	<p>Obtain an IP address automatically - The router receives IP configuration information from a DHCP server.</p> <p>More Options - Click to set more options.</p> <ul style="list-style-type: none"> ● Router Name - Used by some ISPs. Contact your ISP for the appropriate values. ● Domain Name -Used by some ISPs. Contact your ISP for the appropriate values. ● Enable DHCP Client Identifier* - Used by some ISPs that authenticates using DHCP Client Identifier (Option 61). To enable, tick this box and fill out the Username

and Password fields below.

Specify an IP address -Use the IP address, Subnet Mask and Gateway values specified below.

- **IP Address** -WAN IP address assigned by the ISP.
- **Subnet Mask** -WAN subnet mask.
- **Gateway IP Address** - IP address of the WAN Gateway.

WAN IP Alias - Click to enter multiple WAN IP addresses assigned by your ISP.

Index	Enable	Aux. WAN IP
1.	<input checked="" type="checkbox"/>	---
2.	<input type="checkbox"/>	0.0.0.0
3.	<input type="checkbox"/>	0.0.0.0
4.	<input type="checkbox"/>	0.0.0.0
5.	<input type="checkbox"/>	0.0.0.0
6.	<input type="checkbox"/>	0.0.0.0
7.	<input type="checkbox"/>	0.0.0.0
8.	<input type="checkbox"/>	0.0.0.0
9.	<input type="checkbox"/>	0.0.0.0
10.	<input type="checkbox"/>	0.0.0.0
11.	<input type="checkbox"/>	0.0.0.0
12.	<input type="checkbox"/>	0.0.0.0
13.	<input type="checkbox"/>	0.0.0.0

DNS Server IP Address

Primary IP Address - IP address of primary DNS server.

Secondary IP Address - IP address of secondary DNS server.

WAN Connection Detection

Configures how the WAN connection is monitored.

Mode - Choose **ARP Detect**, **Ping Detect**, **Always On** or **Strict ARP Detect** for the system to execute for WAN detection.

- **ARP Detect** - The router broadcasts an ARP request every 5 seconds. If no response is received within 30 seconds, the WAN connection is deemed to have failed.
- **Ping Detect** - The router sends an ICMP (Internet Control Message Protocol) echo request every second to the host, whose address is specified in the Ping IP field, to verify the WAN connection. If the remote host does not respond within 30 seconds, the WAN connection is deemed to have failed.
- **Always On**- The router assumes the WAN connection is always active.

If you choose **Ping Detect** as the detection mode, you have to enter required settings for the following items.

- **Primary/Secondary Ping IP** - Enter Primary or Secondary IP address in this field for pinging.
- **Ping Gateway IP** - Enable this setting to use current

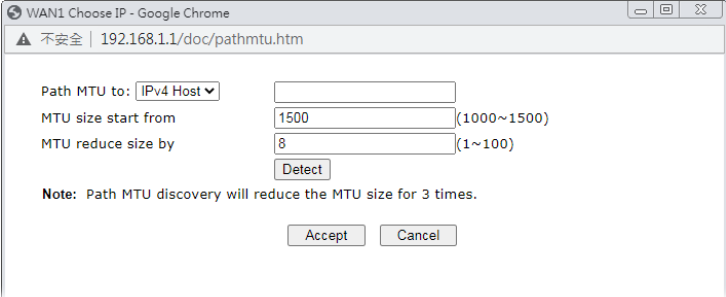
	<p>WAN gateway IP address for ping.</p> <p>With the IP address(es) ping, Vigor router can check if the WAN connection is on or off.</p> <ul style="list-style-type: none"> ● TTL (Time to Live) - Time To Live, the maximum allowed number of hops to the ping destination. Valid values range from 1 to 255. ● Ping Interval - Enter the interval for the system to execute the PING operation. ● Ping Retry - Enter the number of times that the system is allowed to execute the PING operation before WAN disconnection is judged.
<p>MTU</p>	<p>Maximum Transmission Unit, the size of the largest packet, in bytes, that can be transmitted to the WAN. The maximum value is 1500. For PPPoE connections, there is always an 8-byte overhead, so the maximum valid MTU value for PPPoE is 1492.</p> <p>Path MTU Discovery - Use this feature to determine the optimal MTU size for the WAN.</p> <p>Click Path MTU Discovery to open the following dialog.</p>  <ul style="list-style-type: none"> ● Path MTU to - Select Host / IP, for an IPv4 address or Host / IPv6, for an IPv6 address, and then enter the IP address in the textbox. ● MTU size start from - Determine the starting point value of the packet. ● MTU reduce size by - Number of octets by which to decrease the 1500-byte MTU. Start with a 0 value for the reduce size and click the Detect button. If the message Fail is returned, increase the MTU reduce size and try again. Repeat until you see the message Success, indicating that the optimal MTU size has been reached. ● Detect - Click it to detect a suitable MTU value. ● Accept - After clicking it, the detected value will be displayed in the field of MTU.
<p>Keep WAN Connection</p>	<p>Enable PING to keep alive - If selected, ping a WAN host to maintain the connection. If unselected, ping to keep WAN alive is disabled.</p> <p>PING to the IP - IP address of host to be pinged.</p> <p>PING Interval - Number of minutes to wait before sending a ping request to the WAN host.</p>
<p>TTL</p>	<p>Change the TTL value - Check the box to enable the TTL (Time to Live) for a packet transmitted through Vigor router.</p> <ul style="list-style-type: none"> ● If enabled - TTL value will be reduced (-1) when it pass through Vigor router. It will cause the client,

	<p>accessing Internet through Vigor router, be blocked by certain ISP when TTL value becomes "0".</p> <ul style="list-style-type: none"> ● If disabled - TTL value will not be reduced. Then, when a packet passes through Vigor router, it will not be cancelled. That is, the client who sends out the packet will not be blocked by ISP.
RIP Protocol	<p>Routing Information Protocol is abbreviated as RIP(RFC1058). If selected, the router can exchange routing information with other routers.</p>
MAC Address	<p>Default MAC Address - Use the default MAC address for the WAN Ethernet port.</p> <p>Specify a MAC Address - Specify a MAC address for the WAN Ethernet port. Select this option if your ISP authenticates by MAC addresses.</p>

After finishing all the settings here, please click OK to activate them.

II-2-2-3 Details Page for IPv6 – Offline in Ethernet WAN

When Offline is selected, the IPv6 connection will be disabled.

WAN >> Internet Access ?

WAN 1

PPPoE	Static or Dynamic IP	IPv6
<p>Internet Access Mode</p> <p>Connection Type Offline ▼</p>		

II-2-2-4 Details Page for IPv6 – PPP

IPv6 WAN address is assigned along with the IPv4 WAN address during PPPoE negotiation. This IPv6 access mode requires that the IPv4 uses PPPoE.

WAN >> Internet Access ?

WAN 1

PPPoE	Static or Dynamic IP	IPv6
<p>Internet Access Mode</p> <p>Connection Type PPP ▼</p>		
<p>WAN Connection Detection</p> <p>Mode Always On ▼</p>		
<p>RIPng Protocol</p> <p><input type="checkbox"/> Enable</p>		

Note: IPv4 WAN setting should be PPPoE / PPPoA client.

Available settings are explained as follows:

Item	Description
WAN Connection Detection	<p>Configures how the WAN connection is monitored.</p> <p>Mode - Choose Ping Detect or Always On for the system to execute for the WAN detection.</p> <ul style="list-style-type: none"> ● Ping Detect - The router sends an ICMP (Internet Control Message Protocol) echo request every second to the host, whose address is specified in the Ping IP field, to verify the WAN connection. If the remote host does not respond within 30 seconds, the WAN connection is deemed to have failed. ● Always On - The router assumes the WAN connection is always active. <p>If you choose Ping Detect as the detection mode, you have to enter required settings for the following items.</p> <ul style="list-style-type: none"> ● Ping IP/Hostname - Enter IP address in this field for

	<p>pinging.</p> <ul style="list-style-type: none"> ● TTL (Time to Live) - Time To Live, the maximum allowed number of hops to the ping destination. Valid values range from 1 to 255.
RIPng Protocol	RIPng (RIP next generation) offers the same functions and benefits as IPv4 RIP v2.

Below shows an example for successful IPv6 connection based on PPP mode.

Online Status

Physical Connection		System Uptime: 0:2:32	
IPv4	IPv6		
LAN Status			
IP Address			
2001:B010:7300:201:21D:AFF:FEA6:2568/64 (Global)			
FE80::21D:AFF:FEA6:2568/64 (Link)			
TX Packets	RX Packets	TX Bytes	RX Bytes
7	4	690	328
WAN2 IPv6 Status >> Drop PPP			
Enable	Mode	Up Time	
Yes	PPP	0:02:08	
IP		Gateway IP	
2001:B010:7300:201:21D:AFF:FEA6:256A/128 (Global)		FE80::90:1A00:242:AD52	
FE80::1D:AFF:FEA6:256A/128 (Link)			
DNS IP			
2001:8000:168::1			
2001:8000:168::2			
TX Packets	RX Packets	TX Bytes	RX Bytes
7	9	544	1126



Info

At present, the IPv6 prefix can be acquired via the PPPoE mode connection which is available for the areas such as Taiwan (hinet), the Netherlands, Australia and UK.

II-2-2-5 Details Page for IPv6 – TSPC

Tunnel setup protocol client (TSPC) is an application which could help you to connect to IPv6 network easily.

Please make sure your IPv4 WAN connection is OK and apply one free account from hexago (<http://gogonet.gogo6.com/page/freenet6-account>) before you try to use TSPC for network connection. TSPC would connect to tunnel broker and requests a tunnel according to the specifications inside the configuration file. It gets a public IPv6 IP address and an IPv6 prefix from the tunnel broker and then monitors the state of the tunnel in background.

After getting the IPv6 prefix and starting router advertisement daemon (RADVD), the PC behind this router can directly connect to IPv6 the Internet.



WAN 1

PPPoE	Static or Dynamic IP	IPv6
Internet Access Mode		
Connection Type		TSPC ▼
TSPC Configuration		
Username		Max: 63 characters
Password		Max: 63 characters
Tunnel Broker		
WAN Connection Detection		
Mode		Ping Detect ▼
Ping IP/Hostname		
TTL(1-255,0:Auto)		0

Available settings are explained as follows:

Item	Description
Username	Type the name obtained from the broker. It is suggested for you to apply another username and password for http://gogonet.gogo6.com/page/freenet6-account . The maximum length of the name you can set is 63 characters.
Password	Enter the password assigned with the user name.
Tunnel Broker	Enter the address for the tunnel broker IP, FQDN or an optional port number.
WAN Connection Detection	<p>Configures how the WAN connection is monitored.</p> <p>Mode - Choose Ping Detect or Always On for the system to execute for the WAN detection.</p> <ul style="list-style-type: none"> ● Ping Detect - The router sends an ICMP (Internet Control Message Protocol) echo request every second to the host, whose address is specified in the Ping IP field, to verify the WAN connection. If the remote host does not respond within 30 seconds, the WAN connection is deemed to have failed. ● Always On - The router assumes the WAN connection is always active. <p>If you choose Ping Detect as the detection mode, you have to enter required settings for the following items.</p> <ul style="list-style-type: none"> ● Ping IP/Hostname - Enter IP address in this field for pinging. ● TTL (Time to Live) - Time To Live, the maximum allowed number of hops to the ping destination. Valid values range from 1 to 255.

After finished the above settings, click OK to save the settings.

II-2-2-6 Details Page for IPv6 – AICCU

WAN >> Internet Access



WAN 1

PPPoE	Static or Dynamic IP	IPv6
<p>Internet Access Mode</p> <p>Connection Type: <input type="text" value="AICCU"/></p> <p>AICCU Configuration</p> <p><input type="checkbox"/> Always On</p> <p>Username: <input type="text" value="Max: 63 characters"/></p> <p>Password: <input type="text" value="Max: 63 characters"/></p> <p>Tunnel Broker: <input type="text" value="tic.sixxs.net"/></p> <p>Tunnel ID: <input type="text"/></p> <p>Subnet Prefix: <input type="text"/> / <input type="text"/></p> <p>WAN Connection Detection</p> <p>Mode: <input type="text" value="Ping Detect"/></p> <p>Ping IP/Hostname: <input type="text"/></p> <p>TTL(1-255,0:Auto): <input type="text" value="0"/></p>		

Note: If "Always On" is not enabled, AICCU connection would only retry three times.

Available settings are explained as follows:

Item	Description
Always On	If selected, always attempt to reconnect if connection is lost. If unselected, reconnect up to 3 times if connection is lost.
Username	Login Username. Enter the name obtained from the broker. Please apply new account at http://www.sixxs.net/ . It is suggested for you to apply another username and password.
Password	Login Password. Enter the password.
Tunnel Broker	Address of the tunnel broker. The server can provide IPv6 tunnels to sites or end users over IPv4. Enter the address for the tunnel broker IP, FQDN or an optional port number.
Tunnel ID	One user account may have several tunnels. And, each tunnel shall have one specified tunnel ID (e.g., T115394). Type the ID offered by Tunnel Broker.
Subnet Prefix	Type the subnet prefix address obtained from service provider. The maximum length of the prefix you can set is 128 characters.

WAN Connection Detection	<p>Configures how the WAN connection is monitored.</p> <p>Mode - Choose Ping Detect or Always On for the system to execute for the WAN detection.</p> <ul style="list-style-type: none">● Ping Detect - The router sends an ICMP (Internet Control Message Protocol) echo request every second to the host, whose address is specified in the Ping IP field, to verify the WAN connection. If the remote host does not respond within 30 seconds, the WAN connection is deemed to have failed.● Always On - The router assumes the WAN connection is always active. <p>If you choose Ping Detect as the detection mode, you have to enter required settings for the following items.</p> <ul style="list-style-type: none">● Ping IP/Hostname - Enter an IP address in this field for pinging.● TTL (Time to Live) - Time To Live, the maximum allowed number of hops to the ping destination. Valid values range from 1 to 255.
---------------------------------	--

After finished the above settings, click OK to save the settings.

II-2-2-7 Details Page for IPv6 – DHCPv6 Client

DHCPv6 client mode would use DHCPv6 protocol to obtain IPv6 address from server.

WAN >> Internet Access



WAN 3

PPPoE	Static or Dynamic IP	IPv6
Internet Access Mode		
Connection Type		DHCPv6 Client
DHCPv6 Client Configuration		
IAID (Identity Association ID)		1539791662
DUID (DHCP Unique ID)		000300011449bc39be89
Authentication Protocol		None
WAN Connection Detection		
Mode		NS Detect
RIPng Protocol		
<input checked="" type="checkbox"/> Enable		

OK Cancel

Available settings are explained as follows:

Item	Description
DHCPv6 Client Configuration	<p>IAID - Type a number as IAID.</p> <p>DUID - Display the DHCP unique ID used by such WAN interface.</p> <p>Authentication Protocol - Such protocol will be used for the client to be authenticated by DHCPv6 server before accessing into Internet. There are three types can be specified, Reconfigure Key, Delayed and None. In general, the default setting is None.</p> <ul style="list-style-type: none"> ● Reconfigure Key - During the connection process, DHCPv6 server will authenticate the client automatically. ● Delayed - During the connection process, DHCPv6 server will authenticate and identify the client based on the key ID, realm and secret information specified in these fields. <p>Key ID - Type a value (range from 1 to 65535) which will be used to generate HMAC-MD5 value.</p> <p>Realm - The name (1 to 31 characters) typed here will identify the key which generates HMAC-MD5 value.</p> <p>Secret - Type a text (1 to 31 characters) as a unique identifier for each client on each DHCP server.</p>
WAN Connection Detection	<p>Configures how the WAN connection is monitored.</p> <p>Mode - Choose Always On, Ping Detect or NS Detect for the system to execute for WAN detection.</p> <ul style="list-style-type: none"> ● Ping Detect - The router sends an ICMP (Internet Control Message Protocol) echo request every second to the host, whose address is specified in the Ping IP field, to verify the WAN connection. If the remote host does not respond within 30 seconds, the WAN connection is deemed to have failed. ● Always On - The router assumes the WAN connection is always active. ● NS Detect - The router verifies connectivity by issuing

	<p>Neighbor Solicitation packets.</p> <p>If you choose Ping Detect as the detection mode, you have to enter required settings for the following items.</p> <ul style="list-style-type: none"> ● Ping IP/Hostname - Enter an IP address in this field for pinging. ● TTL (Time to Live) -Time To Live, the maximum allowed number of hops to the ping destination. Valid values range from 1 to 255.
RIPng Protocol	RIPng (RIP next generation) offers the same functions and benefits as IPv4 RIP v2.

After finished the above settings, click OK to save the settings.

II-2-2-8 Details Page for IPv6 – Static IPv6

This type allows you to setup static IPv6 address for WAN interface.

WAN >> Internet Access ?

WAN 3

PPPoE	Static or Dynamic IP	IPv6
-------	----------------------	------

Internet Access Mode

Connection Type Static IPv6 ▾

Static IPv6 Address Configuration

IPv6 Address / Prefix Length Add Update Delete

Current IPv6 Address Table

Index	IPv6 Address/Prefix Length	Scope

Static IPv6 Gateway configuration

IPv6 Gateway Address

WAN Connection Detection

Mode NS Detect ▾

RIPng Protocol

Enable

OK Cancel

Available settings are explained as follows:

Item	Description
Static IPv6 Address Configuration	<p>IPv6 Address - WAN IPv6 address assigned by the ISP.</p> <p>Prefix Length - Length of the IPv6 prefix.</p> <p>Add - Click this button to add the values in the IPv6 Address and Prefix Length fields to the IPv6 address table.</p> <p>Update - Click it to modify an existed entry.</p> <p>Delete - To remove an IPv6 address, select it by clicking on the entry in the Current IPv6 Address Table, then click the Delete button.</p>
Current IPv6 Address Table	Display current interface IPv6 address.

Static IPv6 Gateway Configuration	IPv6 Gateway Address - IPv6 address of the ISP gateway.
WAN Connection Detection	<p>Configures how the WAN connection is monitored.</p> <p>Mode - Choose Always On, Ping Detect or NS Detect for the system to execute for WAN detection.</p> <ul style="list-style-type: none"> ● Ping Detect - The router sends an ICMP (Internet Control Message Protocol) echo request every second to the host, whose address is specified in the Ping IP field, to verify the WAN connection. If the remote host does not respond within 30 seconds, the WAN connection is deemed to have failed. ● Always On - The router assumes the WAN connection is always active. ● NS Detect - The router verifies connectivity by issuing Neighbor Solicitation packets. <p>If you choose Ping Detect as the detection mode, you have to enter required settings for the following items.</p> <ul style="list-style-type: none"> ● Ping IP/Hostname - Enter an IP address in this field for pinging. ● TTL (Time to Live) -Time To Live, the maximum allowed number of hops to the ping destination. Valid values range from 1 to 255.
RIPng Protocol	RIPng (RIP next generation) offers the same functions and benefits as IPv4 RIP v2.

After finished the above settings, click **OK** to save the settings.

II-2-2-9 Details Page for IPv6 – 6in4 Static Tunnel

This type allows you to setup 6in4 Static Tunnel for WAN interface.

Such mode allows the router to access IPv6 network through IPv4 network.

However, 6in4 offers a prefix outside of 2002::0/16. So, you can use a fixed endpoint rather than anycast endpoint. The mode has more reliability.



WAN 1

PPPoE	Static or Dynamic IP	IPv6
Internet Access Mode		
Connection Type		6in4 Static Tunnel ▼
6in4 Static Tunnel		
Remote Endpoint IPv4 Address	<input type="text"/>	
6in4 IPv6 Address	<input type="text"/>	/ <input type="text"/> (default:64)
LAN Routed Prefix	<input type="text"/>	/ <input type="text"/> (default:64)
Tunnel TTL	<input type="text"/> (default:255)	
WAN Connection Detection		
Mode	Ping Detect ▼	
Ping IP/Hostname	<input type="text"/>	
TTL(1-255,0:Auto)	<input type="text"/>	

Available settings are explained as follows:

Item	Description
6in4 Static Tunnel	<p>Remote Endpoint IPv4 Address - WAN IPv6 address assigned by the tunnel provider.</p> <p>6in4 IPv6 Address - WAN IPv6 address and prefix length assigned by the tunnel provider.</p> <p>LAN Routed Prefix - LAN IPv6 address prefix and prefix length.</p> <p>Tunnel TTL - Time to live value, which is the maximum number of hops allowed to the endpoint.</p>
WAN Connection Detection	<p>Configures how the WAN connection is monitored.</p> <p>Mode - Choose Always On or Ping Detect for the system to execute for WAN detection.</p> <ul style="list-style-type: none"> ● Ping Detect - The router sends an ICMP (Internet Control Message Protocol) echo request every second to the host, whose address is specified in the Ping IP field, to verify the WAN connection. If the remote host does not respond within 30 seconds, the WAN connection is deemed to have failed. ● Always On - The router assumes the WAN connection is always active. <p>If you choose Ping Detect as the detection mode, you have to enter required settings for the following items.</p> <ul style="list-style-type: none"> ● Ping IP/Hostname - Enter an IP address in this field for pinging. ● TTL (Time to Live) -Time To Live, the maximum allowed number of hops to the ping destination. Valid values range from 1 to 255.

After finished the above settings, click OK to save the settings.

Below shows an example for successful IPv6 connection based on 6in4 Static Tunnel mode.

Online Status

Physical Connection

System Uptime: 0day 0:4:16

IPv4		IPv6	
LAN Status			
IP Address			
2001:4DD0:FF00:83E4:21D:AAFF:FE83:11B4/64 (Global)			
FE80::21D:AAFF:FE83:11B4/64 (Link)			
TX Packets	RX Packets	TX Bytes	RX Bytes
14	80	1244	6815
WAN1 IPv6 Status			
Enable	Mode	Up Time	
Yes	6in4 Static Tunnel	0:04:07	
IP			Gateway IP
2001:4DD0:FF10:83E4::2131/64 (Global)			---
FE80::C0A8:651D/128 (Link)			
TX Packets	RX Packets	TX Bytes	RX Bytes
3	26	211	2302

II-2-2-10 Details Page for IPv6 – 6rd

This type allows you to setup 6rd for WAN interface.

WAN >> Internet Access



WAN 1

PPPoE	Static or Dynamic IP	IPv6
Internet Access Mode		
Connection Type		6rd
6rd Settings		
6rd Mode		<input type="radio"/> Auto 6rd <input checked="" type="radio"/> Static 6rd
Static 6rd Settings		
IPv4 Border Relay:	<input type="text"/>	
IPv4 Mask Length:	<input type="text" value="0"/>	
6rd Prefix:	<input type="text"/>	
6rd Prefix Length:	<input type="text" value="0"/>	
WAN Connection Detection		
Mode	Ping Detect	
Ping IP/Hostname	<input type="text"/>	
TTL(1-255,0:Auto)	<input type="text" value="0"/>	

OK Cancel

Available settings are explained as follows:

Item	Description
6rd Settings	<p>Auto 6rd - Used in conjunction with DHCPv4, the router automatically provisions IPv6 using option 212.</p> <p>Static 6rd - IPv6 configuration information is manually entered.</p>
Static 6rd Settings	<p>IPv4 Border Relay - Enter the IPv4 addresses of the 6rd Border Relay for a given 6rd domain.</p> <p>IPv4 Mask Length - Number of high-order bits that are identical in the IPv4 addresses within the 6rd domain. These bits are excluded when constructing the 6rd delegated prefix. It may be any value between 0 and 32.</p> <p>6rd Prefix - Enter the 6rd IPv6 address.</p> <p>6rd Prefix Length - Enter the IPv6 prefix length for the 6rd IPv6 prefix in number of bits.</p>
WAN Connection Detection	<p>Configures how the WAN connection is monitored.</p> <p>Mode - Choose Always On or Ping Detect for the system to execute for WAN detection.</p> <ul style="list-style-type: none"> Ping Detect - The router sends an ICMP (Internet Control Message Protocol) echo request every second to the host, whose address is specified in the Ping IP field, to verify the WAN connection. If the remote host does not respond within 30 seconds, the WAN connection is deemed to have failed. Always On - The router assumes the WAN connection is

	<p>always active.</p> <p>If you choose Ping Detect as the detection mode, you have to enter required settings for the following items.</p> <ul style="list-style-type: none"> ● Ping IP/Hostname - Enter an IP address in this field for pinging. ● TTL (Time to Live) -Time To Live, the maximum allowed number of hops to the ping destination. Valid values range from 1 to 255.
--	--

After finished the above settings, click OK to save the settings.

Below shows an example for successful IPv6 connection based on 6rd mode.

Online Status

Physical Connection		System Uptime: 0day 0:9:15	
IPv4	IPv6		
LAN Status			
IP Address			
2001:E41:A865:1D00:21D:AAFF:FE83:11B4/64 (Global)			
FE80::21D:AAFF:FE83:11B4/64 (Link)			
TX Packets	RX Packets	TX Bytes	RX Bytes
15	113	1354	18040
WAN1 IPv6 Status			
Enable	Mode	Up Time	
Yes	6rd	0:09:06	
IP			Gateway IP
2001:E41:A865:1D01:21D:AAFF:FE83:11B5/128 (Global)			---
FE80::C0A8:651D/128 (Link)			
TX Packets	RX Packets	TX Bytes	RX Bytes
13	29	967	2620

II-2-3 Multi-VLAN

Multi-VLAN lets you configure multiple VLAN groups.

Channel 1 to 8 have the following fixed assignments and cannot be altered.

Channels 13 through 52 can be configured as virtual WANs.

General

The system allows you to set up to eight channels used as multi-VLAN.

WAN >> Multi-VLAN

Multi-VLAN						
General						
Channel	Display Name	Enable	WAN Type	VLAN Tag	Port-based Bridge	
1		<input checked="" type="checkbox"/>	Fiber(WAN1)	None		
3		<input checked="" type="checkbox"/>	Ethernet(WAN3)	None		
5		<input checked="" type="checkbox"/>	Ethernet(WAN5)	None		
6		<input checked="" type="checkbox"/>	Ethernet(WAN6)	None		
7		<input checked="" type="checkbox"/>	Ethernet(WAN7)	None		
8		<input checked="" type="checkbox"/>	Ethernet(WAN8)	None		
13.	WAN13	<input type="checkbox"/>	Fiber(WAN1)	None	<input type="checkbox"/> Enable	<input type="checkbox"/> P2 <input type="checkbox"/> P4 <input type="checkbox"/> P9 <input type="checkbox"/> P10 <input type="checkbox"/> P11 <input type="checkbox"/> P12
14.	WAN14	<input type="checkbox"/>	Fiber(WAN1)	None	<input type="checkbox"/> Enable	<input type="checkbox"/> P2 <input type="checkbox"/> P4 <input type="checkbox"/> P9 <input type="checkbox"/> P10 <input type="checkbox"/> P11 <input type="checkbox"/> P12
15.	WAN15	<input type="checkbox"/>	Fiber(WAN1)	None	<input type="checkbox"/> Enable	<input type="checkbox"/> P2 <input type="checkbox"/> P4 <input type="checkbox"/> P9 <input type="checkbox"/> P10 <input type="checkbox"/> P11 <input type="checkbox"/> P12
16.	WAN16	<input type="checkbox"/>	Fiber(WAN1)	None	<input type="checkbox"/> Enable	<input type="checkbox"/> P2 <input type="checkbox"/> P4 <input type="checkbox"/> P9 <input type="checkbox"/> P10 <input type="checkbox"/> P11 <input type="checkbox"/> P12
17.	WAN17	<input type="checkbox"/>	Fiber(WAN1)	None	<input type="checkbox"/> Enable	<input type="checkbox"/> P2 <input type="checkbox"/> P4 <input type="checkbox"/> P9 <input type="checkbox"/> P10 <input type="checkbox"/> P11 <input type="checkbox"/> P12
18.	WAN18	<input type="checkbox"/>	Fiber(WAN1)	None	<input type="checkbox"/> Enable	<input type="checkbox"/> P2 <input type="checkbox"/> P4 <input type="checkbox"/> P9 <input type="checkbox"/> P10 <input type="checkbox"/> P11 <input type="checkbox"/> P12
19.	WAN19	<input type="checkbox"/>	Fiber(WAN1)	None	<input type="checkbox"/> Enable	<input type="checkbox"/> P2 <input type="checkbox"/> P4 <input type="checkbox"/> P9 <input type="checkbox"/> P10 <input type="checkbox"/> P11 <input type="checkbox"/> P12
20.	WAN20	<input type="checkbox"/>	Fiber(WAN1)	None	<input type="checkbox"/> Enable	<input type="checkbox"/> P2 <input type="checkbox"/> P4 <input type="checkbox"/> P9 <input type="checkbox"/> P10 <input type="checkbox"/> P11 <input type="checkbox"/> P12
21.	WAN21	<input type="checkbox"/>	Fiber(WAN1)	None	<input type="checkbox"/> Enable	<input type="checkbox"/> P2 <input type="checkbox"/> P4 <input type="checkbox"/> P9 <input type="checkbox"/> P10 <input type="checkbox"/> P11 <input type="checkbox"/> P12
22.	WAN22	<input type="checkbox"/>	Fiber(WAN1)	None	<input type="checkbox"/> Enable	<input type="checkbox"/> P2 <input type="checkbox"/> P4 <input type="checkbox"/> P9 <input type="checkbox"/> P10 <input type="checkbox"/> P11 <input type="checkbox"/> P12
23.	WAN23	<input type="checkbox"/>	Fiber(WAN1)	None	<input type="checkbox"/> Enable	<input type="checkbox"/> P2 <input type="checkbox"/> P4 <input type="checkbox"/> P9 <input type="checkbox"/> P10 <input type="checkbox"/> P11 <input type="checkbox"/> P12
24.	WAN24	<input type="checkbox"/>	Fiber(WAN1)	None	<input type="checkbox"/> Enable	<input type="checkbox"/> P2 <input type="checkbox"/> P4 <input type="checkbox"/> P9 <input type="checkbox"/> P10 <input type="checkbox"/> P11 <input type="checkbox"/> P12
25.	WAN25	<input type="checkbox"/>	Fiber(WAN1)	None	<input type="checkbox"/> Enable	<input type="checkbox"/> P2 <input type="checkbox"/> P4 <input type="checkbox"/> P9 <input type="checkbox"/> P10 <input type="checkbox"/> P11 <input type="checkbox"/> P12
26.	WAN26	<input type="checkbox"/>	Fiber(WAN1)	None	<input type="checkbox"/> Enable	<input type="checkbox"/> P2 <input type="checkbox"/> P4 <input type="checkbox"/> P9 <input type="checkbox"/> P10 <input type="checkbox"/> P11 <input type="checkbox"/> P12
27.	WAN27	<input type="checkbox"/>	Fiber(WAN1)	None	<input type="checkbox"/> Enable	<input type="checkbox"/> P2 <input type="checkbox"/> P4 <input type="checkbox"/> P9 <input type="checkbox"/> P10 <input type="checkbox"/> P11 <input type="checkbox"/> P12
28.	WAN28	<input type="checkbox"/>	Fiber(WAN1)	None	<input type="checkbox"/> Enable	<input type="checkbox"/> P2 <input type="checkbox"/> P4 <input type="checkbox"/> P9 <input type="checkbox"/> P10 <input type="checkbox"/> P11 <input type="checkbox"/> P12
29.	WAN29	<input type="checkbox"/>	Fiber(WAN1)	None	<input type="checkbox"/> Enable	<input type="checkbox"/> P2 <input type="checkbox"/> P4 <input type="checkbox"/> P9 <input type="checkbox"/> P10 <input type="checkbox"/> P11 <input type="checkbox"/> P12

Available settings are explained as follows:

Item	Description
Channel	Display the number of each channel. Channels 1~8 are used by the Internet Access web user interface and can not be configured here. Channels 13 ~ 52 are configurable.
Enable	Display whether the settings in this channel are enabled (checked) or not (unchecked).
WAN Type	Displays the physical medium that the channel will use.
VLAN Tag	Displays the VLAN tag value that will be used for the packets traveling on this channel.
Port-based Bridge	The network traffic flowing on each channel will be identified by the system via their VLAN Tags. Channels using the same WAN type may not configure the same VLAN tag value. Enable - Check this box to enable the port-based bridge function on this channel. P2 ~ P12 - Check the box(es) to build bridge connection on LAN.

Click any index (13-52) to get the following web page:

WAN >> Multi-VLAN >> Channel 13

Enable Channel13 :

Display Name:

WAN Type : Fiber(WAN1) ▼

Fiber(WAN1)

Ethernet(WAN3)

Ethernet(WAN5)

Ethernet(WAN6)

Ethernet(WAN7)

Ethernet(WAN8)

General Settings

VLAN Header:

VLAN Tag:

Priority:

Note:
Tag value must be set between 1~4095 and unique for each channel.
Only one channel can be untagged (equal to 0) at a time.

Open Port-based Bridge Connection for this Channel

Physical Members

P2 P4 P9 P10 P11 P12

Note:
1. P12 is reserved for NAT use, and cannot be configured for bridge mode.
2. If the port be configured for bridge mode, the setting of the port in LAN >> VLAN Configuration will not work.

Open WAN Interface for this Channel

WAN Application: Management IPTV

WAN Setup: Static or Dynamic IP ▼ Load Balance:

ISP Access Setup	WAN IP Network Settings	
ISP Name: <input type="text"/>	<input checked="" type="radio"/> Obtain an IP address automatically	
Username: <input type="text"/>	Router Name: <input type="text" value="Vigor"/> *	
Password: <input type="text"/>	Domain Name: <input type="text"/> *	
PPP Authentication: PAP or CHAP ▼	*: Required for some ISPs	
<input checked="" type="checkbox"/> Always On	<input type="radio"/> Specify an IP address	
Idle Timeout: <input type="text" value="-1"/> second(s)	IP Address: <input type="text"/>	
IP Address From ISP	Subnet Mask: <input type="text"/>	
Fixed IP: <input type="radio"/> Yes <input checked="" type="radio"/> No (Dynamic IP)	Gateway IP Address: <input type="text"/>	
Fixed IP Address: <input type="text"/>	DNS Server IP Address	
	Primary IP Address: <input type="text" value="8.8.8.8"/>	
	Secondary IP Address: <input type="text" value="8.8.4.4"/>	

Available settings are explained as follows:

Item	Description
Enable Channel 13~52	Enable - Click it to enable the configuration of this channel. Disable - Click it to disable the configuration of this channel.
WAN Type	The connections and interfaces created in every channel may select a specific WAN type to be built upon. In the Multi-VLAN application, only the Ethernet WAN type is available. The user will be able to select the physical WAN interface the channel shall use here.
General Settings	VLAN Tag - Type the value as the VLAN ID number. Valid settings are in the range from 1 to 4095. The network traffic flowing on each channel will be identified by the system via their VLAN Tags. Channels using the same WAN type may not

	<p>configure the same VLAN tag value.</p> <p>Priority - Choose the number to determine the packet priority for such VLAN. The range is from 0 to 7.</p>
Open Port-based Bridge Connection for this Channel	<p>If selected, bridge this channel to one or more LAN ports.</p> <p>Physical Members - If selected, a channel is bridged to this LAN port.</p> <p>Note: LAN port P1 is reserved for NAT use and cannot be selected for bridging.</p>
Open WAN Interface for this Channel	<p>If selected, NAT (Network Address Translation) will be applied to this channel to create a virtual WAN. The virtual WAN carries the same number as the channel itself.</p> <p>WAN Application - The intended usage of this channel.</p> <ul style="list-style-type: none"> ● Management - The router can be managed using the web-based configuration, telnet and TR-069 via this channel. ● IPTV - IGMP packets can be sent to IPTV servers on this channel. <p>WAN Setup - The WAN access method of this channel. Available options are PPPoE/PPPoA and Static or Dynamic IP.</p> <ul style="list-style-type: none"> ● PPPoE/PPPoA - When PPPoE/PPPoA is selected, the ISP Access Setup and IP Address From ISP settings are available for configuration, and will be used to establish the WAN connection. ● Static or Dynamic IP - When Static or Dynamic IP is selected, the WAN IP Network Settings and DNS Server IP Address settings are available for configuration, and will be used to establish the WAN connection.
ISP Access Setup	<p>Enter your allocated username, password and authentication parameters according to the information provided by your ISP.</p> <p>Username - Name provided by the ISP for PPPoE/PPPoA authentication. Maximum length is 62 characters.</p> <p>Password - Password provided by the ISP for PPPoE/PPPoA authentication. Maximum length is 62 characters.</p> <p>PPP Authentication -The protocol used for PPP authentication.</p> <ul style="list-style-type: none"> ● PAP only- Only PAP (Password Authentication Protocol) is used. ● PAP or CHAP- Both PAP and CHAP (Challenge-Handshake Authentication Protocol) can be used for PPP authentication. Router negotiates with the PPTP or L2TP server to determine which protocol to use. <p>Always On - If selected, the router will maintain the PPPoE/PPPoA connection.</p> <p>Idle Timeout - Maximum length of time, in seconds, of idling allowed (no traffic) before the connection is dropped.</p> <p>IP Address from ISP - Specifies how the WAN IP address of the channel configured.</p> <ul style="list-style-type: none"> ● Fixed IP <ul style="list-style-type: none"> Yes - IP address entered in the Fixed IP Address field will be used as the IP address of the virtual WAN. No - Virtual WAN IP address will be assigned by the ISP's PPPoE/PPPoA server.

	<ul style="list-style-type: none"> ● Fixed IP Address - Enter an IP address.
WAN IP Network Settings	<p>Obtain an IP address automatically - Select this option if the router is to receive IP configuration information from a DHCP server.</p> <ul style="list-style-type: none"> ● Router Name - Sets the value of DHCP Option 12, which is used by some ISPs. ● Domain Name - Sets the value of DHCP Option 15, which is used by some ISPs. <p>Specify an IP address - Select this option to manually enter the IP address.</p> <ul style="list-style-type: none"> ● IP Address - Enter the IP address. ● Subnet Mask - Enter the subnet mask. ● Gateway IP Address - Enter gateway IP address. <p>DNS Server IP Address - Enter the primary IP address for the router if you want to use Static IP mode. If necessary, Enter secondary IP address for necessity in the future.</p>

After finished the above settings, click **OK** to save the settings and return to previous page.

II-2-4 WAN Budget

This function is used to determine the data *traffic volume* for each WAN interface respectively to prevent overcharges for data transmission by the ISP. Please note that the Quota Limit and Billing cycle day of month settings will need to be configured correctly first in order for some period calculations to be performed correctly.

The WAN Budget feature allows you to conveniently keep track of Internet traffic volume. You can:

- set up calendar cycles to monitor;
- limit your Internet usage according to your ISP's quota;
- set up action(s) to take when the quota is exceeded.

II-2-4-1 General Setup

WAN >> WAN Budget

General Setup			Status		
Index	Enable	Quota	When quota exceeded	Time cycle	Duration
WAN1	<input type="checkbox"/>	0MB/0MB			0/00/00 00:00~0/00/00 00:00
WAN2	<input type="checkbox"/>	0MB/0MB			0/00/00 00:00~0/00/00 00:00
WAN3	<input type="checkbox"/>	0MB/0MB			0/00/00 00:00~0/00/00 00:00
WAN4	<input type="checkbox"/>	0MB/0MB			0/00/00 00:00~0/00/00 00:00
WAN5	<input type="checkbox"/>	0MB/0MB			0/00/00 00:00~0/00/00 00:00
WAN6	<input type="checkbox"/>	0MB/0MB			0/00/00 00:00~0/00/00 00:00
WAN7	<input type="checkbox"/>	0MB/0MB			0/00/00 00:00~0/00/00 00:00
WAN8	<input type="checkbox"/>	0MB/0MB			0/00/00 00:00~0/00/00 00:00

Note:

1. The budget traffic information provided here is for reference only, please consult your ISP for the actual traffic usage and charges.
2. When hardware acceleration function is used, the monitored WAN traffic of Ethernet WAN interfaces may be slightly inaccurate.

Item	Description
Index	The WAN port. Click to configure WAN Budget for a particular WAN.
Enable	v - WAN Budget is enabled on this WAN. x - WAN Budget is disabled on this WAN.
Quota	The current cycle's Internet usage is expressed as x/y where x is the cumulative usage and y is the upper limit. For example, 100MB/200MB means the usage thus far in this cycle is 100MB, and the upper limit is 200MB.
When quota exceeded	Actions to be taken once the quota is reached. Shutdown - WAN will be disabled. Mail Alert - Email will be sent to the administrator.
Time cycle	Reset frequency of the usage data. Monthly - The Monthly option in the Criterion and Action tab was used to set up the usage quota. User Defined : The User Defined option in the Criterion and Action tab was used to set up the usage quota.

Duration	Start and end timestamps of the current cycle.
----------	--

Click WAN1 (to WAN8) link to open the following web page.

WAN >> WAN Budget

WAN 1

Enable

Criterion and Action

Quota Limit: MB

When quota exceeded :

Shutdown WAN interface

Using **Notification Object**

Set **Mail Alert** or **SMS message**.

Monthly **Custom**

Select the day of a month when your (cellular) data resets.

Data quota resets on day at

Note:

1. Please make sure the **Time and Date** of the router is configured.
2. SMS message and mail will be sent when the usage reaches 95% and 100% of quota.

Available settings are explained as follows:

Item	Description
Enable	When selected, WAN Budget is enabled for this WAN.
Quota Limit	Enter the data traffic quota allowed for such WAN interface. There are two unit (MB and GB) offered for you to specify.
When quota exceeded	<p>Check the box(es) as the condition(s) for the system to perform when the traffic has exceeded the budget limit.</p> <p>Shutdown WAN interface - All the outgoing traffic through such WAN interface will be terminated.</p> <ul style="list-style-type: none"> ● Using Notification Object - The system will send out a notification based on the content of the notification object. ● Set Mail Alert - The system will send out a warning message to the administrator when the quota is running out. However, the connection charges will be calculated continuously. ● Set SMS message - The system will send out SMS message to the administrator when the quota is running out.
Monthly	<p>Some ISP might apply for the network limitation based on the traffic limit per month. This setting is to offer a mechanism of resetting the traffic record every month.</p> <p>Monthly Custom</p> <p>Select the day of a month when your (cellular) data resets.</p> <p>Data quota resets on day <input type="text" value="1"/> at <input type="text" value="00:00"/></p> <p>Data quota resets on day ... - You can determine the starting day in one month.</p>
Custom	This setting allows the user to define the billing cycle according to his request. The WAN budget will be reset with

an interval of billing cycle.

Monthly is default setting. If long period or a short period is required, use **Custom**. The period of cycle duration is between 1 day and 60 days. You can determine the cycle duration by specifying the days and the hours. In addition, you can specify which day of today is in a cycle.

Use Cycle in hours -

Monthly	Custom
---------	--------

Use Cycle in hours

Use Cycle in days

Usage counter resets at the beginning of each cycle.

Cycle duration : days and hours

Today is day in the cycle.

- **Cycle duration:** Specify the days and hours to reset the traffic record. For example, 7 means the whole cycle is 7 days; 20 means the whole cycle is 20 days. When the time is up, the router will reset the traffic record automatically.
- **Today is day -** Specify the day in the cycle as the starting point which Vigor router will reset the traffic record. For example, "3" means the third day of the cycle duration.

Use Cycle in days -

Monthly	Custom
---------	--------

Use Cycle in hours

Use Cycle in days

Usage counter resets at the beginning of each cycle.

Cycle duration : days.

Today is day in the cycle and data quota resets at

- **Cycle duration:** Specify the days to reset the traffic record. For example, 7 means the whole cycle is 7 days; 20 means the whole cycle is 20 days. When the time is up, the router will reset the traffic record automatically.
- **Today is day -** Specify the day and time for data quota rest in the cycle as the starting point which Vigor router will reset the traffic record. For example, "3" means the third day of the cycle duration.

After finished the above settings, click **OK** to save the settings.

II-2-4-2 Status

The status page displays the status WAN budget, including the duration and the usage.

WAN >> WAN Budget

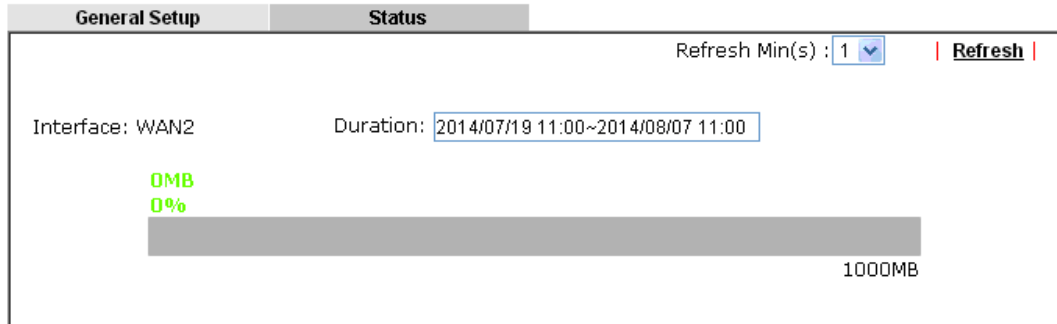

If the WAN budget is exhausted, a lock will be displayed on the page if **Shutdown WAN interface** is selected. Which means no data transmission will be carried out. Moreover, the system will send out a warning message to the administrator if **Mail Alert** is selected. Or, the system will send out SMS message to the administrator if **SMS message** is selected.

WAN >> WAN Budget

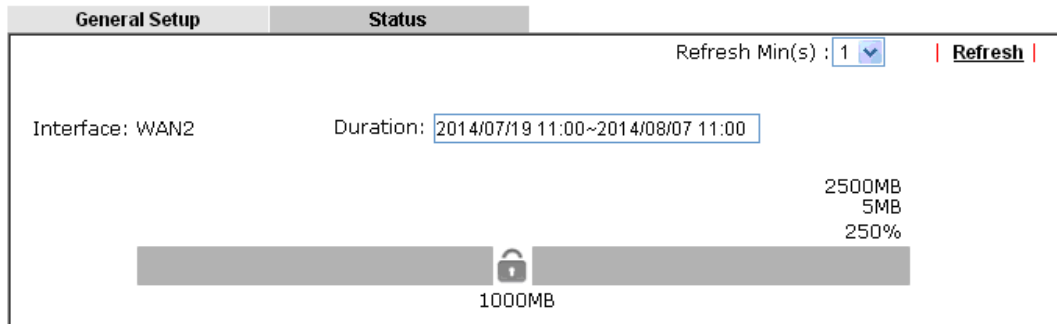

II-3 LAN

A LAN(Local Area Network) comprises a collection of LAN clients, which are networked devices on your premises. A LAN client can be a computer, a printer, a Voice-over-IP (VoIP) phone, a mobile phone, a gaming console, an Internet Protocol Television (IPTV), etc, and can have either a wired (using Ethernet cabling) or wireless (using Wi-Fi) network connection.

LAN clients within the same LAN are normally able to communicate with one another directly, as they are peers to one another, unless measures, such as firewalls or VLANs, have been put in place to restrict such access. Nowadays the most common LAN firewalls are implemented on the LAN client itself. For example, Microsoft Windows since Windows XP and Apple OS X have built-in firewalls that can be configured to restrict traffic coming in and going out of the computer. VLANs, on the other hand, are usually set up using network switches or routers.

To communicate with the hosts outside of the LAN, LAN clients have to go through a network gateway, which in most cases is a router that sits between the LAN and the ISP network, which is the WAN. The router acts as a director to ensure traffic between the LAN and the WAN reach their intended destinations.

IP Address

On most broadband networks, the ISP assigns a single WAN IP address to the subscriber. All LAN clients have to share this WAN IP address when accessing the Internet. To achieve this, a technique called Network Address Translation (NAT) is used. Under NAT, a private block of IP addresses is assigned to the LAN clients, which communicate with WAN hosts through the router, also known as the gateway.

On outgoing traffic to the WAN, the router makes note that a LAN client has attempted to reach a WAN host, and forwards the request to the intended WAN recipient.

On traffic incoming to the LAN from a WAN host, the router checks its records to see if a matching outstanding request from a LAN client to this WAN host exists, and if so, forwards it to the LAN client. Otherwise, the traffic is dropped.

There are 3 distinct blocks of IPv4 address that are reserved for use as private IP addresses on a LAN.

Name	IP Address Range	Number of Available Addresses	Largest Subnet Mask
24-bit Block	10.0.0.0 to 10.255.255.255	16,777,216	255.0.0.0
20-bit Block	172.16.0.0 to 172.31.255.255	1,048,576	255.240.0.0
16-bit Block	192.168.0.0 to 192.168.255.255	65,536	255.255.0.0

The default beginning IP Address of LAN 1 is 192.168.1.1, and the Subnet Mask is 255.255.255.0, for a total of 254 assignable IP addresses, from 192.168.1.1 to 192.168.1.254. The final IP address of the selected range is reserved for routing and cannot be assigned to a LAN client.

In most cases, the default IP address block should work satisfactorily. However, there are situations where you need to select a different address block, such as when you need to communicate with other LANs that already use the same address block.

Private IP addresses can be assigned automatically to LAN clients using Dynamic Host Configuration Protocol (DHCP), or manually assigned. The DHCP server can either be the router (the most common case), or a separate server, that hands out IP addresses to DHCP clients.

Alternatively, static IP addresses can be manually configured on LAN clients as part of their network settings. No matter how IP addresses are configured, it is important that no two devices get the same IP address. If both DHCP and static assignment are used on a network, it is important to exclude the static IP addresses from the DHCP IP pool. For example, if your LAN uses the 192.168.1.x subnet and you have 20 DHCP clients and 20 static IP clients, you could configure 192.168.1.10 as the Start IP Address, 50 as the IP Pool Counts (enough for the current number of DHCP clients, plus room for future expansion), and use addresses greater than 192.168.1.100 for static assignment.

Web User Interface

To begin configuring the LAN settings, select LAN>>General Settings from the menu bar of the Web UI.

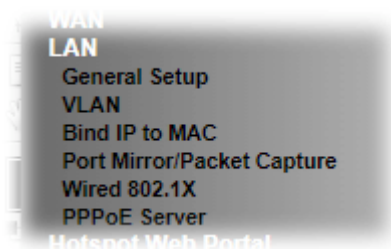

II-3-1 General Setup

This page provides you the general settings for LAN. Click LAN to open the LAN settings page and choose General Setup.

There are several subnets provided by the router which allow users to divide groups into different subnets (LAN2 - LAN100). In addition, different subnets can link for each other by configuring Inter-LAN Routing. At present, LAN1 setting is fixed with NAT mode only. LAN2 - LAN50 can be operated under NAT or Route mode. IP Routed Subnet can be operated under Route mode.

LAN 1 is always enabled and is used as the default subnet. LANs 2 to 100 are subnets to be used in conjunction with Virtual LANs (VLANs). Each VLAN can be configured to allow or disallow communication with other VLANs using the Inter-LAN Routing matrix.

To configure a subnet, select its Details Page button to bring up the LAN Details Page.

LAN >> General Setup

General Setup

Index	Description	Enable	DHCP	IP Address		
LAN 1		<input checked="" type="checkbox"/>	<input checked="" type="checkbox"/>	192.168.1.1	Details Page	<input checked="" type="checkbox"/> IPv6
IP Routed Subnet		<input type="checkbox"/>	<input checked="" type="checkbox"/>	192.168.0.1	Details Page	

[DHCP Server Option](#)

Note:
 1. Please enable LAN 2 - 100 on LAN >> VLAN page before configure them.
 Force router to use "DNS server IP address" settings specified in LAN1 ▾

Inter-LAN Routing

Subnet	LAN 1	LAN 2	LAN 3	LAN 4	LAN 5	LAN 6	LAN 7	LAN 8	LAN 9	LAN 10	LAN 11	LAN 12	LAN 13	LAN 14	LAN 15	LAN 16	LAN 17	LAN 18
LAN1	<input checked="" type="checkbox"/>	<input type="checkbox"/>	<input type="checkbox"/>	<input type="checkbox"/>	<input type="checkbox"/>	<input type="checkbox"/>	<input type="checkbox"/>	<input type="checkbox"/>	<input type="checkbox"/>	<input type="checkbox"/>	<input type="checkbox"/>	<input type="checkbox"/>	<input type="checkbox"/>	<input type="checkbox"/>	<input type="checkbox"/>	<input type="checkbox"/>	<input type="checkbox"/>	<input type="checkbox"/>
LAN2	<input type="checkbox"/>	<input checked="" type="checkbox"/>	<input type="checkbox"/>	<input type="checkbox"/>	<input type="checkbox"/>	<input type="checkbox"/>	<input type="checkbox"/>	<input type="checkbox"/>	<input type="checkbox"/>	<input type="checkbox"/>	<input type="checkbox"/>	<input type="checkbox"/>	<input type="checkbox"/>	<input type="checkbox"/>	<input type="checkbox"/>	<input type="checkbox"/>	<input type="checkbox"/>	<input type="checkbox"/>
LAN3	<input type="checkbox"/>	<input type="checkbox"/>	<input checked="" type="checkbox"/>	<input type="checkbox"/>	<input type="checkbox"/>	<input type="checkbox"/>	<input type="checkbox"/>	<input type="checkbox"/>	<input type="checkbox"/>	<input type="checkbox"/>	<input type="checkbox"/>	<input type="checkbox"/>	<input type="checkbox"/>	<input type="checkbox"/>	<input type="checkbox"/>	<input type="checkbox"/>	<input type="checkbox"/>	<input type="checkbox"/>
LAN4	<input type="checkbox"/>	<input type="checkbox"/>	<input type="checkbox"/>	<input checked="" type="checkbox"/>	<input type="checkbox"/>	<input type="checkbox"/>	<input type="checkbox"/>	<input type="checkbox"/>	<input type="checkbox"/>	<input type="checkbox"/>	<input type="checkbox"/>	<input type="checkbox"/>	<input type="checkbox"/>	<input type="checkbox"/>	<input type="checkbox"/>	<input type="checkbox"/>	<input type="checkbox"/>	<input type="checkbox"/>
LAN5	<input type="checkbox"/>	<input type="checkbox"/>	<input type="checkbox"/>	<input type="checkbox"/>	<input checked="" type="checkbox"/>	<input type="checkbox"/>	<input type="checkbox"/>	<input type="checkbox"/>	<input type="checkbox"/>	<input type="checkbox"/>	<input type="checkbox"/>	<input type="checkbox"/>	<input type="checkbox"/>	<input type="checkbox"/>	<input type="checkbox"/>	<input type="checkbox"/>	<input type="checkbox"/>	<input type="checkbox"/>
LAN6	<input type="checkbox"/>	<input type="checkbox"/>	<input type="checkbox"/>	<input type="checkbox"/>	<input type="checkbox"/>	<input checked="" type="checkbox"/>	<input type="checkbox"/>	<input type="checkbox"/>	<input type="checkbox"/>	<input type="checkbox"/>	<input type="checkbox"/>	<input type="checkbox"/>	<input type="checkbox"/>	<input type="checkbox"/>	<input type="checkbox"/>	<input type="checkbox"/>	<input type="checkbox"/>	<input type="checkbox"/>

[OK](#)

Available settings are explained as follows:

Item	Description
General Setup	Allow to configure settings for each subnet respectively.
Index	Display all of the LAN items.

	<p>Enable - Basically, LAN1 status is enabled in default. LAN2 -LAN100 and IP Routed Subnet can be configured after enabling via LAN>>VLAN.</p> <p>DHCP- LAN1 is configured with DHCP in default. If required, please check the DHCP box for each LAN.</p> <p>IP Address - Display the IP address for each LAN item. Such information is set in default and you can not modify it.</p> <p>Details Page - Click it to access into the setting page. Each LAN will have different LAN configuration page. Each LAN must be configured in different subnet.</p> <p>IPv6 - Click it to access into the settings page of IPv6.</p>
DHCP Server Options	<p>DHCP packets can be processed by adding option number and data information when such function is enabled.</p> <p>For detailed information, refer to later section.</p>
Force router to use "DNS Server IP address"...	<p>Force Vigor router to use DNS servers configured in LAN port instead of DNS servers given by the Internet Access server (PPPoE, PPTP, L2TP or DHCP server).</p>
Inter-LAN Routing	<p>Check the box to link two or more different subnets (LAN and LAN).</p> <p>Inter-LAN Routing allows different LAN subnets to be interconnected or isolated.</p> <p>It is only available when the VLAN functionality is enabled. Refer to section II-3-2 VLAN on how to set up VLANs.</p> <p>In the Inter-LAN Routing matrix, a selected checkbox means that the 2 intersecting LANs can communicate with each other.</p>

When you finish the configuration, please click **OK** to save and exit this page.



Info

To configure a subnet, select its Details Page button to bring up the LAN Details Page.

II-3-1-1 Details Page for LAN1 – Ethernet TCP/IP and DHCP Setup

This page has two tabs, LAN Ethernet TCP/IP and DHCP Setup, which sets up the IPv4 LAN environment, and LAN IPv6 Setup, which sets up the IPv6 environment.

LAN >> General Setup

LAN 1 Ethernet TCP / IP and DHCP Setup	LAN 1 IPv6 Setup
Network Configuration Description: <input type="text"/> For NAT Usage IP Address: <input type="text" value="192.168.100.1"/> Subnet Mask: <input type="text" value="255.255.255.0 / 24"/> <input type="button" value="LAN IP Alias"/> RIP Protocol Control: <input type="text" value="Disable"/>	DHCP Server Configuration <input type="radio"/> Disable <input checked="" type="radio"/> Enable Server <input type="radio"/> Enable Relay Agent Start IP Address: <input type="text" value="192.168.100.10"/> IP Pool Counts: <input type="text" value="200"/> (max. 4093) Gateway IP Address: <input type="text" value="192.168.100.1"/> Lease Time: <input type="text" value="86400"/> (s) <input checked="" type="checkbox"/> Clear DHCP lease for inactive clients periodically DNS Server IP Address Primary IP Address: <input type="text"/> Secondary IP Address: <input type="text"/>

Note: Change IP Address or Subnet Mask in Network Configuration will also change HA LAN1 Virtual IP to the same domain IP.

Available settings are explained as follows:

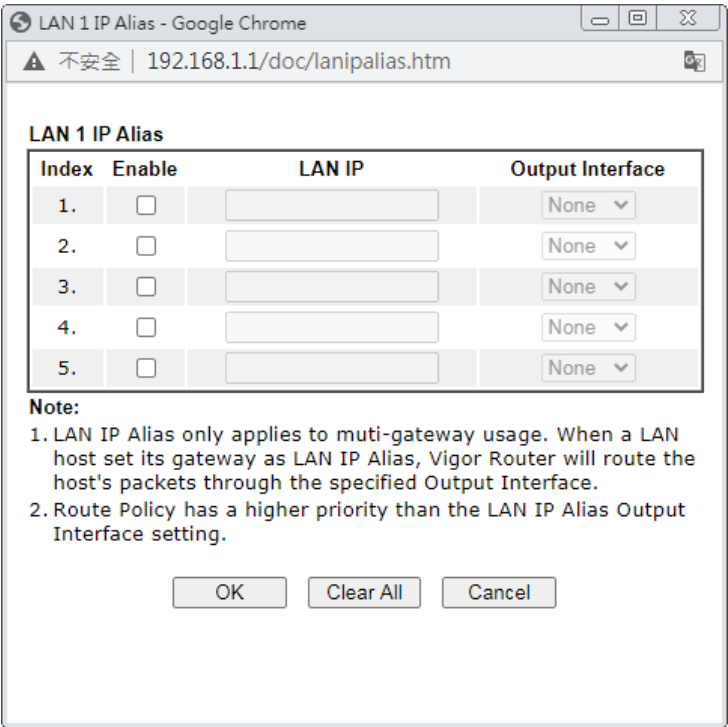
Item	Description
Network Configuration	<p>For NAT Usage,</p> <p>IP Address - This is the IP address of the router. (Default: 192.168.1.1).</p> <p>Subnet Mask - The subnet mask, together with the IP Address field, indicates the maximum number of clients allowed on the subnet. (Default: 255.255.255.0/ 24).</p> <p>LAN IP Alias -Such feature allows specifying multiple gateways (under a switch) with different WAN interfaces for accessing the Internet via the Vigor router.</p>  <p>Note:</p> <ol style="list-style-type: none"> LAN IP Alias only applies to multi-gateway usage. When a LAN host set its gateway as LAN IP Alias, Vigor Router will route the host's packets through the specified Output Interface. Route Policy has a higher priority than the LAN IP Alias Output Interface setting. <p><input type="button" value="OK"/> <input type="button" value="Clear All"/> <input type="button" value="Cancel"/></p> <p>RIP Protocol Control,</p> <p>Enable -When Enabled, the router will attempt to exchange</p>

	routing information with neighbouring routers using the Routing Information Protocol.
DHCP Server Configuration	<p>DHCP stands for Dynamic Host Configuration Protocol. The router by factory default acts a DHCP server for your network so it automatically dispatches related IP settings to any local user configured as a DHCP client. It is highly recommended that you leave the router enabled as a DHCP server if you do not have a DHCP server for your network.</p> <p>If you want to use another DHCP server in the network other than the Vigor Router's, you can let Relay Agent help you to redirect the DHCP request to the specified location.</p> <p>Disable - Disables the built-in DHCP server on the router.</p> <p>Enable Server - Enables the built-in DHCP server on the router.</p> <ul style="list-style-type: none"> ● Start IP Address - The beginning LAN IP address that is given out to LAN DHCP clients. ● IP Pool Counts - The maximum number of IP addresses to be handed out by DHCP. The default value is 200. Valid range is between 1 and 1021. The actual number of IP addresses available for assignment is the IP Pool Counts, or 1021 minus the last octet of the Start IP Address, whichever is smaller. ● Gateway IP Address - The IP address of the gateway, which is the host on the LAN that relays all traffic coming into and going out of the LAN. The gateway is normally the router, and therefore the Gateway IP Address should be identical to the IP Address in the Network Configuration section above. ● Lease Time - The maximum duration DHCP-issued IP addresses can be used before they have to be renewed. ● Clear DHCP lease for inactive clients periodically - If selected, the router sends ARP requests recycles IP addresses previously assigned to inactive DHCP clients to prevent exhaustion of the IP address pool. <ul style="list-style-type: none"> Note: When Clear DHCP lease for inactive clients periodically is enabled, router will do the following: <ul style="list-style-type: none"> ■ Check activities of DHCP clients by ARP requests every minute when the available DHCP IP addresses are less than 30 ■ Clear DHCP lease when the client is not responding ARP replies. <p>Enable Relay Agent - When selected, all DHCP requests are forwarded to a DHCP server outside of the LAN subnet, and whose address is specified in the DHCP Server IP Address field.</p> <ul style="list-style-type: none"> ● DHCP Server IP Address - IP Address of the DHCP server to which DHCP requests from LAN clients are forwarded.
DNS Server IP Address	<p>DNS stands for Domain Name System. Every Internet host must have a unique IP address, also they may have a human-friendly, easy to remember name such as www.yahoo.com. The DNS server converts the user-friendly name into its equivalent IP address.</p> <p>When these fields are populated, they will be used as the IP addresses of the DNS server information in DHCPv6 responses, overriding the ISP-supplied DNS server addresses.</p>

Primary IP Address - You must specify a DNS server IP address here because your ISP should provide you with usually more than one DNS Server.

Secondary IP Address - You can specify secondary DNS server IP address here because your ISP often provides you more than one DNS Server.

The default DNS Server IP address can be found via Online Status:

Online Status

Physical Connection System Uptime: 22:22:45

IPv4		IPv6	
LAN Status	Primary DNS: 8.8.8.8	Secondary DNS: 8.8.4.4	
IP Address	TX Packets	RX Packets	
192.168.1.1	0	41533	

If both the Primary IP and Secondary IP Address fields are left empty, the router will assign its own IP address to local users as a DNS proxy server and maintain a DNS cache.

If the IP address of a domain name is already in the DNS cache, the router will resolve the domain name immediately. Otherwise, the router forwards the DNS query packet to the external DNS server by establishing a WAN (e.g. DSL/Cable) connection.

When you finish the configuration, please click **OK** to save and exit this page.

II-3-1-2 Details Page for IP Routed Subnet

LAN >> General Setup

TCP/IP and DHCP Setup for IP Routed Subnet

<p>Network Configuration</p> <p><input type="radio"/> Enable <input checked="" type="radio"/> Disable</p> <p>Description: <input type="text"/></p> <p>For Routing Usage</p> <p>IP Address: <input type="text" value="192.168.0.1"/></p> <p>Subnet Mask: <input type="text" value="255.255.255.0 / 24"/></p> <hr/> <p>RIP Protocol Control: <input type="text" value="Disable"/></p>	<p>DHCP Server Configuration</p> <p>Start IP Address: <input type="text"/></p> <p>IP Pool Counts: <input type="text" value="0"/> (max. 32)</p> <p>Lease Time: <input type="text" value="259200"/> (s)</p> <p><input type="checkbox"/> Use LAN Port <input checked="" type="checkbox"/> P11 <input checked="" type="checkbox"/> P12</p> <p><input checked="" type="checkbox"/> Use MAC Address</p> <hr/> <table border="1"> <thead> <tr> <th>Index</th> <th>Matched MAC Address</th> <th>given IP Address</th> </tr> </thead> <tbody> <tr> <td colspan="3" style="height: 50px;"> </td> </tr> </tbody> </table> <p>MAC Address: <input type="text" value="FF:FF:FF:FF:FF:FF"/></p> <p style="text-align: center;"> <input type="button" value="Add"/> <input type="button" value="Delete"/> <input type="button" value="Edit"/> <input type="button" value="Cancel"/> </p>	Index	Matched MAC Address	given IP Address			
Index	Matched MAC Address	given IP Address					

Available settings are explained as follows:

Item	Description
Network Configuration	<p>Enable/Disable - Click Enable to enable such configuration; click Disable to disable such configuration.</p> <p>For Routing Usage,</p> <p>IP Address - This is the IP address of the router. (Default: 192.168.1.1).</p> <p>Subnet Mask - The subnet mask, together with the IP Address field, indicates the maximum number of clients allowed on</p>

	<p>the subnet. (Default: 255.255.255.0/ 24).</p> <p>RIP Protocol Control,</p> <p>Enable - When Enabled, the router will attempt to exchange routing information with neighbouring routers using the Routing Information Protocol.</p>
<p>DHCP Server Configuration</p>	<p>DHCP stands for Dynamic Host Configuration Protocol. The router by factory default acts a DHCP server for your network so it automatically dispatch related IP settings to any local user configured as a DHCP client. It is highly recommended that you leave the router enabled as a DHCP server if you do not have a DHCP server for your network.</p> <p>Start IP Address - Enter a value of the IP address pool for the DHCP server to start with when issuing IP addresses. If the 1st IP address of your router is 192.168.1.1, the starting IP address must be 192.168.1.2 or greater, but smaller than 192.168.1.254.</p> <p>IP Pool Counts - Enter the maximum number of PCs that you want the DHCP server to assign IP addresses to. The default is 50 and the maximum is 253.</p> <p>Lease Time - Enter the time to determine how long the IP address assigned by DHCP server can be used.</p> <p>Use LAN Port - Specify an IP for IP Route Subnet. If it is enabled, DHCP server will assign IP address automatically for the clients coming from P11 and/or P12. Please check the box of P11 and P12.</p> <p>Use MAC Address - Check such box to specify MAC address.</p> <p>MAC Address: Enter the MAC Address of the host one by one and click Add to create a list of hosts which can be assigned, deleted or edited from above pool. Set a list of MAC Address for 2nd DHCP server will help router to assign the correct IP address of the correct subnet to the correct host. So those hosts in 2nd subnet won't get an IP address belonging to 1st subnet.</p> <p>Add - Enter the MAC address in the boxes and click this button to add.</p> <p>Delete - Click it to delete the selected MAC address.</p> <p>Edit - Click it to edit the selected MAC address.</p> <p>Cancel - Click it to cancel the job of adding, deleting and editing.</p>

When you finish the configuration, please click **OK** to save and exit this page.

II-3-1-3 Details Page for LAN1 – IPv6 Setup

There are two configuration pages for LAN1, Ethernet TCP/IP and DHCP Setup (based on IPv4) and IPv6 Setup. Click the tab for each type and refer to the following explanations for detailed information. Below shows the settings page for IPv6.

LAN >> General Setup

LAN 1 Ethernet TCP / IP and DHCP Setup
LAN 1 IPv6 Setup

Enable IPv6

WAN Primary Interface WAN1

Static IPv6 Address

IPv6 Address / Prefix Length

/
Add

Delete

Unique Local Address(ULA) configuration

Off :: / 64

Current IPv6 Address Table

Index	IPv6 Address/Prefix Length	Scope
1	FE80::21D:AAFF:FE4B:3E80/64	Link

DNS Server IPv6 Address Deploy when WAN is up

Primary DNS Server 2001:4860:4860::8888

Secondary DNS Server 2001:4860:4860::8844

Management SLAAC(stateless)

Other Option(O-bit)

DHCPv6 Server

Enable Server Disable Server

IPv6 Address Random Allocation

Auto IPv6 range

Start IPv6 Address ::

End IPv6 Address ::

Advance setting Edit

Advance setting
Edit

OK

It provides 2 daemons for LAN side IPv6 address configuration. One is SLAAC(stateless) and the other is DHCPv6 Server (Stateful).

Available settings are explained as follows:

Item	Description
Enable IPv6	Enables or disables IPv6 on the LAN.
WAN Primary Interface	Select the WAN to be used for IPv6 traffic.
Static IPv6 Address	<p>Enter IPv6 Address and Prefix length to be added, or click an existing IPv6 address to be deleted in the Current IPv6 Address Table below and the values will be automatically copied over.</p> <p>IPv6 Address -Type static IPv6 address for LAN.</p> <p>Prefix Length - Enter the fixed value for prefix length.</p> <p>Add - Click it to add a new entry.</p> <p>Delete - Click it to remove an existed entry.</p>
Unique Local Address (ULA) configuration	<p>Unique Local Addresses (ULAs) are private IPv6 addresses assigned to LAN clients.</p> <p>Off - ULA is disabled.</p> <p>Manually ULA Prefix - LAN clients will be assigned ULAs generated based on the prefix manually entered.</p> <p>Auto ULA Prefix - LAN clients will be assigned ULAs using an automatically-determined prefix.</p>
Current IPv6 Address Table	Display current used IPv6 addresses.
DNS Server IPv6 Address	<p>Deploy when WAN is up - The RA (router advertisement) packets will be sent to LAN PC with DNS server information only when network connection by any one of WAN interfaces is up.</p> <p>Enable - The RA (router advertisement) packets will be sent to LAN PC with DNS server information no matter WAN connection is up or not.</p> <ul style="list-style-type: none"> ● Primary DNS Sever - Enter the IPv6 address for Primary DNS server. ● Secondary DNS Server -Type another IPv6 address for DNS server if required. <p>Disable - DNS server will not be used.</p>
Management	<p>Configures the Managed Address Configuration flag (M-bit) in Route Advertisements.</p> <ul style="list-style-type: none"> ● Off - No configuration information is sent using Route Advertisements. ● SLAAC(stateless) - M-bit is unset. ● DHCPv6(stateful) - M-bit is set, which indicates to LAN clients that they should acquire all IPv6 configuration information from a DHCPv6 server. The DHCPv6 server can either be the one built into the Vigor2860, or a separate DHCPv6 server. <p>Other Option (O-bit) - When selected, the Other Configuration flag is set, which indicates to LAN clients that IPv6 configuration information besides LAN IPv6 addresses is available from a DHCPv6 server.</p> <p>Setting the M-bit (see Management above) has the same effect as implicitly setting the O-bit, as DHCPv6 supplies all IPv6 configuration information, including what is indicated as available when the O-bit is set.</p>

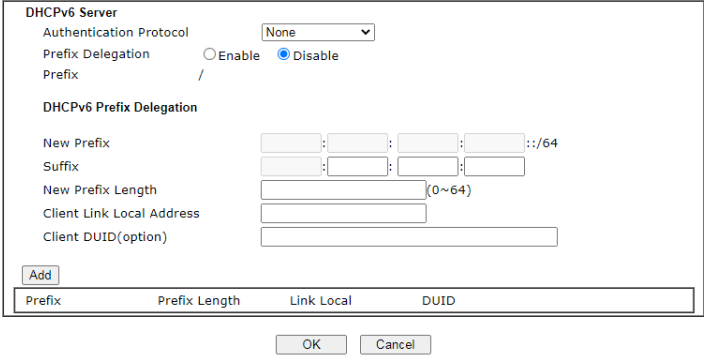
<p>Other Option(O-bit)</p>	<p>When selected, the Other Configuration flag is set, which indicates to LAN clients that IPv6 configuration information besides LAN IPv6 addresses is available from a DHCPv6 server.</p> <p>Setting the M-bit (see Management above) has the same effect as implicitly setting the O-bit, as DHCPv6 supplies all IPv6 configuration information, including what is indicated as available when the O-bit is set.</p>
<p>DHCPv6 Server</p>	<p>Enable Server -Click it to enable DHCPv6 server. DHCPv6 Server could assign IPv6 address to PC according to the Start/End IPv6 address configuration.</p> <p>Disable Server -Click it to disable DHCPv6 server.</p> <p>IPv6 Address Random Allocation - Check it to assign the DHCPv6 IP address randomly to prevent the attacks from the IPv6 reconnaissance techniques.</p> <p>Auto IPv6 range - When selected, the router's built-in DHCPv6 server decides the LAN IPv6 address range to be used. When deselected, LAN IPv6 addresses given out will be within the range as specified in the Start IPv6 Address and End IPv6 Address.</p> <ul style="list-style-type: none"> ● Start IPv6 Address / End IPv6 Address -Enter the start and end address for IPv6 server. <p>Advance setting - Click the Edit button to bring up the IPv6 Advanced Settings page.</p> <p>LAN >> General Setup</p> 
<p>Advance setting</p>	<p>The Advanced Settings page has additional settings for Router Advertisement and enabling multiple WANs for IPv6 traffic.</p>

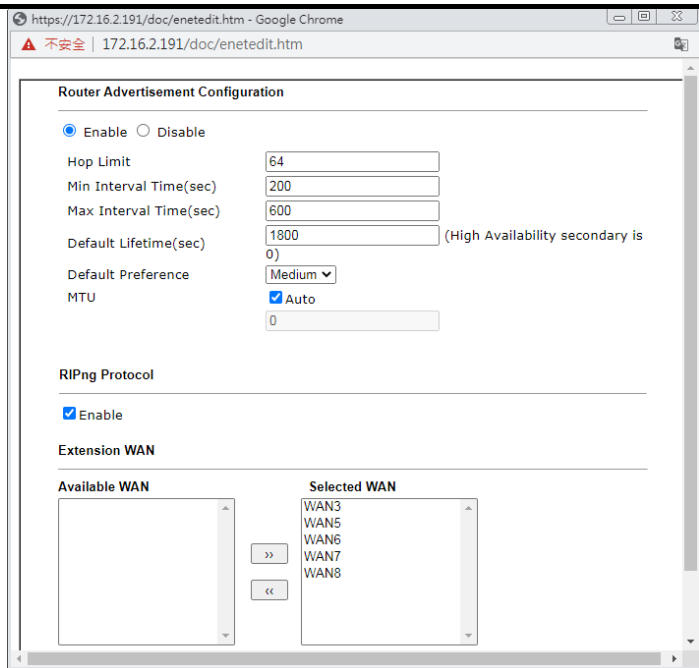

Router Advertisement Configuration - Click **Enable** to enable router advertisement server. The router advertisement daemon sends Router Advertisement messages, specified by RFC 2461, to a local Ethernet LAN periodically and when requested by a node sending a Router Solicitation message. These messages are required for IPv6 stateless auto-configuration.

Disable - Click it to disable router advertisement server.

Hop Limit - The value is required for the device behind the router when IPv6 is in use. Default value of hop limit field in Route Advertisement messages.

Min/Max Interval Time (sec) - Minimum/ Maximum time, in seconds, between unsolicited multicast route advertisement messages sent by the RA server.

Default Lifetime (sec) - Time, in seconds, that the router is to be used as the default router.

Default Preference - Default preference value (Low, Medium, High) of the router sent in route advertisement messages.

MTU - It means Max Transmit Unit for packet. If **Auto** is selected, the router determines the MTU value to send in route advertisement messages.

RIPng Protocol - RIPng (RIP next generation) offers the same functions and benefits as IPv4 RIP v2.

Extension WAN - In addition to the default WAN used for IPv6 traffic specified in the WAN Primary Interface in the LAN IPv6 Setup page, additional WANs can be selected to carry IPv6 traffic by enabling them in the Extension WAN section.

Available WAN - Additional WANs available but not currently selected to carry IPv6 traffic.

Selected WAN - Additional WANs selected to carry IPv6 traffic.

After making changes on the Advance setting page, click the **OK** button to retain the changes and return to the LAN IPv6 Setup page. Be sure to click **OK** on the LAN IPv6 Setup page or else changes made on the Advance setting page will not be saved.

II-3-1-4 DHCP Server Option

DHCP Options can be configured by clicking the Advanced button on the LAN General Setup screen.

LAN >> General Setup

DHCP Server Customized Status

IPv4 IPv6 Set to Factory Default

5 entries per page

Enable	Interface	Option	Type	Data
Enable: <input checked="" type="checkbox"/>				
<input type="checkbox"/> All <input checked="" type="checkbox"/> LAN1 <input type="checkbox"/> LAN2 <input type="checkbox"/> LAN3 <input type="checkbox"/> LAN4 <input type="checkbox"/> LAN5 <input type="checkbox"/> LAN6 <input type="checkbox"/> LAN7 <input type="checkbox"/> LAN8 <input type="checkbox"/> LAN9 <input type="checkbox"/> LAN10 <input type="checkbox"/> LAN11 <input type="checkbox"/> LAN12 <input type="checkbox"/> LAN13 <input type="checkbox"/> LAN14 <input type="checkbox"/> LAN15 <input type="checkbox"/> LAN16 <input type="checkbox"/> LAN17 <input type="checkbox"/> LAN18 <input type="checkbox"/> LAN19 <input type="checkbox"/> LAN20 <input type="checkbox"/> LAN21 <input type="checkbox"/> LAN22 <input type="checkbox"/> LAN23 <input type="checkbox"/> LAN24 <input type="checkbox"/> LAN25 <input type="checkbox"/> LAN26 <input type="checkbox"/> LAN27 <input type="checkbox"/> LAN28 <input type="checkbox"/> LAN29 <input type="checkbox"/> LAN30 <input type="checkbox"/> LAN31 <input type="checkbox"/> LAN32 <input type="checkbox"/> LAN33 <input type="checkbox"/> LAN34 <input type="checkbox"/> LAN35 <input type="checkbox"/> LAN36 <input type="checkbox"/> LAN37 <input type="checkbox"/> LAN38 <input type="checkbox"/> LAN39 <input type="checkbox"/> LAN40 <input type="checkbox"/> LAN41 <input type="checkbox"/> LAN42 <input type="checkbox"/> LAN43 <input type="checkbox"/> LAN44 <input type="checkbox"/> LAN45 <input type="checkbox"/> LAN46 <input type="checkbox"/> LAN47 <input type="checkbox"/> LAN48 <input type="checkbox"/> LAN49 <input type="checkbox"/> LAN50 Interface: <input type="checkbox"/> LAN51 <input type="checkbox"/> LAN52 <input type="checkbox"/> LAN53 <input type="checkbox"/> LAN54 <input type="checkbox"/> LAN55 <input type="checkbox"/> LAN56 <input type="checkbox"/> LAN57 <input type="checkbox"/> LAN58 <input type="checkbox"/> LAN59 <input type="checkbox"/> LAN60 <input type="checkbox"/> LAN61 <input type="checkbox"/> LAN62 <input type="checkbox"/> LAN63 <input type="checkbox"/> LAN64 <input type="checkbox"/> LAN65 <input type="checkbox"/> LAN66 <input type="checkbox"/> LAN67 <input type="checkbox"/> LAN68 <input type="checkbox"/> LAN69 <input type="checkbox"/> LAN70 <input type="checkbox"/> LAN71 <input type="checkbox"/> LAN72 <input type="checkbox"/> LAN73 <input type="checkbox"/> LAN74 <input type="checkbox"/> LAN75 <input type="checkbox"/> LAN76 <input type="checkbox"/> LAN77 <input type="checkbox"/> LAN78 <input type="checkbox"/> LAN79 <input type="checkbox"/> LAN80 <input type="checkbox"/> LAN81 <input type="checkbox"/> LAN82 <input type="checkbox"/> LAN83 <input type="checkbox"/> LAN84 <input type="checkbox"/> LAN85 <input type="checkbox"/> LAN86 <input type="checkbox"/> LAN87 <input type="checkbox"/> LAN88 <input type="checkbox"/> LAN89 <input type="checkbox"/> LAN90 <input type="checkbox"/> LAN91 <input type="checkbox"/> LAN92 <input type="checkbox"/> LAN93 <input type="checkbox"/> LAN94 <input type="checkbox"/> LAN95 <input type="checkbox"/> LAN96 <input type="checkbox"/> LAN97 <input type="checkbox"/> LAN98 <input type="checkbox"/> LAN99 <input type="checkbox"/> LAN100 <input type="checkbox"/> IP Routed Subnet				
Next Server IP Address/SIAddr : <input type="text"/>				
Option Number: <input type="text"/>				
DataType: <input checked="" type="radio"/> ASCII Character (EX :Option:18, Data:/path) <input type="radio"/> Hexadecimal Digit (Please check note 4.) <input type="radio"/> Address List (EX :Option:44, Data:172.16.2.10,172.16.2.20...)				
Data: <input type="text"/> Max 127 characters				
<input type="button" value="Add"/> <input type="button" value="Update"/> <input type="button" value="Delete"/> <input type="button" value="Reset"/>				

Available settings are explained as follows:

Item	Description
Customized List	Shows all the DHCP options that have been configured in the system.
Enable	If selected, DHCP option entry is enabled. If unselected, DHCP option entry is disabled.
Interface	LAN interface(s) to which this entry is applicable.
Next Server IP Address/SIAddr	Overrides the DHCP Next Server IP address (DHCP Option 66) supplied by the DHCP server.
Option Number	DHCP option number (e.g., 100).
DataType	Type of data in the Data field: ASCII Character - A text string. Example: /path. Hexadecimal Digit - A hexadecimal string. Valid characters are from 0 to 9 and from a to f. Example: 2f70617468. Address List - One or more IPv4 addresses, delimited by commas.
Data	Data of this DHCP option.
Add	To add a DHCP option entry modeled after an existing entry, click the model entry in Customized List . The data entry fields will be populated with values from the model entry. After making all necessary changes for the new entry, click Add to create it.
Update	To modify an existing DHCP option entry, click on it in Customized List . The data entry fields will be populated with the current values from the entry. After making all

	necessary changes, click Update to save the changes.
Delete	To delete a DHCP option entry, click on it in Customized List , and then click Delete .
Reset	Clear the current settings.

II-3-2 VLAN

Virtual Local Area Networks (VLANs) allow you to subdivide your LAN to facilitate management or to improve network security.

Select **LAN>>VLAN** from the menu bar of the Web UI to bring up the VLAN Configuration page.

Tagged VLAN

The tagged VLANs (802.1q) can mark data with a VLAN identifier. This identifier can be carried through an onward Ethernet switch to specific ports. The specific VLAN clients can also pick up this identifier as it is just passed to the LAN. You can set the priorities for LAN-side QoS. You can assign each of VLANs to each of the different IP subnets that the router may also be operating, to provide even more isolation. The said functionality is **tag-based multi-subnet**.

LAN >> VLAN Configuration

VLAN Configuration

Enable

	LAN Port						VLAN Tag			
	P2	P4	P9	P10	P11	P12	Subnet	Enable	VID	Priority
VLAN0	<input type="checkbox"/>	<input type="checkbox"/>	<input type="checkbox"/>	<input type="checkbox"/>	<input type="checkbox"/>	<input type="checkbox"/>	LAN 1	<input type="checkbox"/>	0	0
VLAN1	<input type="checkbox"/>	<input type="checkbox"/>	<input type="checkbox"/>	<input type="checkbox"/>	<input type="checkbox"/>	<input type="checkbox"/>	LAN 1	<input type="checkbox"/>	0	0
VLAN2	<input type="checkbox"/>	<input type="checkbox"/>	<input type="checkbox"/>	<input type="checkbox"/>	<input type="checkbox"/>	<input type="checkbox"/>	LAN 1	<input type="checkbox"/>	0	0
VLAN3	<input type="checkbox"/>	<input type="checkbox"/>	<input type="checkbox"/>	<input type="checkbox"/>	<input type="checkbox"/>	<input type="checkbox"/>	LAN 1	<input type="checkbox"/>	0	0
VLAN4	<input type="checkbox"/>	<input type="checkbox"/>	<input type="checkbox"/>	<input type="checkbox"/>	<input type="checkbox"/>	<input type="checkbox"/>	LAN 1	<input type="checkbox"/>	0	0
VLAN5	<input type="checkbox"/>	<input type="checkbox"/>	<input type="checkbox"/>	<input type="checkbox"/>	<input type="checkbox"/>	<input type="checkbox"/>	LAN 1	<input type="checkbox"/>	0	0
VLAN6	<input type="checkbox"/>	<input type="checkbox"/>	<input type="checkbox"/>	<input type="checkbox"/>	<input type="checkbox"/>	<input type="checkbox"/>	LAN 1	<input type="checkbox"/>	0	0
VLAN7	<input type="checkbox"/>	<input type="checkbox"/>	<input type="checkbox"/>	<input type="checkbox"/>	<input type="checkbox"/>	<input type="checkbox"/>	LAN 1	<input type="checkbox"/>	0	0
VLAN8	<input type="checkbox"/>	<input type="checkbox"/>	<input type="checkbox"/>	<input type="checkbox"/>	<input type="checkbox"/>	<input type="checkbox"/>	LAN 1	<input type="checkbox"/>	0	0
VLAN9	<input type="checkbox"/>	<input type="checkbox"/>	<input type="checkbox"/>	<input type="checkbox"/>	<input type="checkbox"/>	<input type="checkbox"/>	LAN 1	<input type="checkbox"/>	0	0
VLAN10	<input type="checkbox"/>	<input type="checkbox"/>	<input type="checkbox"/>	<input type="checkbox"/>	<input type="checkbox"/>	<input type="checkbox"/>	LAN 1	<input type="checkbox"/>	0	0



Info

Settings in this page only applied to LAN port but not WAN port.

Available settings are explained as follows:

Item	Description
Enable	Enables or disables VLAN functionality.
VLAN#	Virtual LANs.
LAN Port	P2 - P12 - Physical Ethernet ports on the router. Select the LAN port(s) to group them under the selected VLAN.

Subnet	Select a LAN subnet from LAN 1 to LAN 100 to make the selected VLAN mapping to the specified subnet only.
VLAN Tag	<p>Enable - Select to enable 802.1Q tagging on this VLAN.</p> <p>The router will add specific VLAN number to all packets on the LAN while sending them out.</p> <p>Please enter the tag value and specify the priority for the packets sending by LAN.</p> <p>VID - VLAN Identifier. Valid values are form 0 to 4095. VIDs must be unique.</p> <p>Priority - Valid values are from 0 to 7, where 1 has the lowest priority, followed by 0, and finally from 2 to 7 in increasing order of priority.</p>
Permit untagged device in P12 to access router	Select to allow untagged hosts connected to LAN port P12 to access the router. In case you have incorrectly configured VLAN functionality, you will still be able to access the router via the Web UI, and telnet and SSH shells to adjust the configuration.

Inter-LAN Routing

The Vigor router supports up to 99 VLANs. Each VLAN can be set up to use one or more of the Ethernet ports and wireless LAN Service Set Identifiers (SSIDs). Within the grid of VLANs (horizontal rows) and LAN interfaces (vertical columns),

- all hosts within the same VLAN (horizontal row) are visible to one another
- all hosts connected to the same LAN or WLAN interface (vertical column) are visible to one another if
 - they belong to the same VLAN, or
 - they belong to different VLANs, and inter-LAN routing (LAN>>General Setup) between them is enabled (see below).

LAN >> General Setup

General Setup

Index	Description	Enable	DHCP	IP Address		
LAN 1		<input checked="" type="checkbox"/>	<input checked="" type="checkbox"/>	192.168.100.1	Details Page	<input checked="" type="checkbox"/> IPv6
IP Routed Subnet		<input type="checkbox"/>	<input checked="" type="checkbox"/>	192.168.0.1	Details Page	

DHCP Server Option

Note:

Please enable LAN 2 - 100 on [LAN >> VLAN](#) page before configure them.

Force router to use "DNS server IP address" settings specified in

Inter-LAN Routing

Subnet	LAN 1	LAN 2	LAN 3	LAN 4	LAN 5	LAN 6	LAN 7	LAN 8	LAN 9	LAN 10	LAN 11	LAN 12	LAN 13	LAN 14	LAN 15	LAN 16	LAN 17	LAN 18
LAN 1	<input checked="" type="checkbox"/>	<input type="checkbox"/>	<input type="checkbox"/>	<input type="checkbox"/>	<input type="checkbox"/>	<input type="checkbox"/>	<input type="checkbox"/>	<input type="checkbox"/>	<input type="checkbox"/>	<input type="checkbox"/>	<input type="checkbox"/>	<input type="checkbox"/>	<input type="checkbox"/>	<input type="checkbox"/>	<input type="checkbox"/>	<input type="checkbox"/>	<input type="checkbox"/>	<input type="checkbox"/>
LAN 2	<input type="checkbox"/>	<input checked="" type="checkbox"/>	<input type="checkbox"/>	<input type="checkbox"/>	<input type="checkbox"/>	<input type="checkbox"/>	<input type="checkbox"/>	<input type="checkbox"/>	<input type="checkbox"/>	<input type="checkbox"/>	<input type="checkbox"/>	<input type="checkbox"/>	<input type="checkbox"/>	<input type="checkbox"/>	<input type="checkbox"/>	<input type="checkbox"/>	<input type="checkbox"/>	<input type="checkbox"/>
LAN 3	<input type="checkbox"/>	<input type="checkbox"/>	<input checked="" type="checkbox"/>	<input type="checkbox"/>	<input type="checkbox"/>	<input type="checkbox"/>	<input type="checkbox"/>	<input type="checkbox"/>	<input type="checkbox"/>	<input type="checkbox"/>	<input type="checkbox"/>	<input type="checkbox"/>	<input type="checkbox"/>	<input type="checkbox"/>	<input type="checkbox"/>	<input type="checkbox"/>	<input type="checkbox"/>	<input type="checkbox"/>
LAN 4	<input type="checkbox"/>	<input type="checkbox"/>	<input type="checkbox"/>	<input checked="" type="checkbox"/>	<input type="checkbox"/>	<input type="checkbox"/>	<input type="checkbox"/>	<input type="checkbox"/>	<input type="checkbox"/>	<input type="checkbox"/>	<input type="checkbox"/>	<input type="checkbox"/>	<input type="checkbox"/>	<input type="checkbox"/>	<input type="checkbox"/>	<input type="checkbox"/>	<input type="checkbox"/>	<input type="checkbox"/>
LAN 5	<input type="checkbox"/>	<input type="checkbox"/>	<input type="checkbox"/>	<input type="checkbox"/>	<input checked="" type="checkbox"/>	<input type="checkbox"/>	<input type="checkbox"/>	<input type="checkbox"/>	<input type="checkbox"/>	<input type="checkbox"/>	<input type="checkbox"/>	<input type="checkbox"/>	<input type="checkbox"/>	<input type="checkbox"/>	<input type="checkbox"/>	<input type="checkbox"/>	<input type="checkbox"/>	<input type="checkbox"/>
LAN 6	<input type="checkbox"/>	<input type="checkbox"/>	<input type="checkbox"/>	<input type="checkbox"/>	<input type="checkbox"/>	<input checked="" type="checkbox"/>	<input type="checkbox"/>	<input type="checkbox"/>	<input type="checkbox"/>	<input type="checkbox"/>	<input type="checkbox"/>	<input type="checkbox"/>	<input type="checkbox"/>	<input type="checkbox"/>	<input type="checkbox"/>	<input type="checkbox"/>	<input type="checkbox"/>	<input type="checkbox"/>

Inter-LAN Routing allows different LAN subnets to be interconnected or isolated. It is only available when the VLAN functionality is enabled. In the Inter-LAN Routing matrix, a selected checkbox means that the 2 intersecting LANs can communicate with each other.

Vigor router features a hugely flexible VLAN system. In its simplest form, each of the Gigabit LAN ports can be isolated from each other, for example to feed different companies or departments but keeping their local traffic completely separated.

II-3-3 Bind IP to MAC

This function is used to bind the IP and MAC address in LAN to have a strengthening control in network. With the Bind IP to MAC feature you can reserve LAN IP addresses for LAN clients. Each reserved IP address is associated with a Media Access Control (MAC) address.

Click LAN and click **Bind IP to MAC** to open the setup page.

LAN >> Bind IP to MAC

Bind IP to MAC

Enable Disable
 Strict Bind
 Apply Strict Bind to Subnet:

ARP Table | [Select All](#) | [Sort](#) | [Refresh](#) | [Add/Update to IP Bind List](#)

IP Address	MAC Address	HOST ID

IP Address:

MAC Address:

Comment:

IP Bind List (Limit: 2048 entries) | [Select All](#) | [Sort](#) |

Index	IP Address	MAC Address	HOST ID	Comment

Backup IP Bind List: Upload From File: 未選擇任何檔案

Available settings are explained as follows:

Item	Description
Enable	MAC addresses that have an IP address assigned on this page will receive that IP address through DHCP.
Disable	MAC address-to-IP address bindings configured on this page are ignored by the DHCP server when assigning IP addresses through DHCP.
Strict Bind	<p>Check the box to block the connection of the IP/MAC which is not listed in IP Bind List.</p> <p>LAN clients will be assigned IP addresses according to the MAC-to-IP address associations on this page. LAN client whose MAC address has not been bound to an IP address will be denied network access.</p>

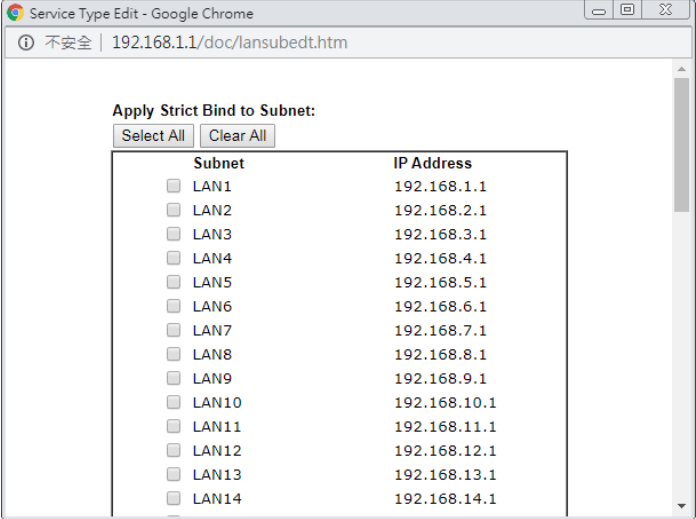
	<p>Note: Before selecting Strict Bind, make sure at least one valid MAC address has been bound to an IP address. Otherwise no LAN clients will have network access, and it will not be possible to connect to the router to make changes to its configuration.</p> <p>Apply Strict Bind to Subnet – Choose the subnet(s) for applying the rules of Bind IP to MAC.</p> 
ARP Table	This table is the LAN ARP table of this router. The information for IP and MAC will be displayed in this field. Each pair of IP and MAC address listed in ARP table can be selected and added to IP Bind List by clicking Add below.
Select All	Select all entries in the ARP Table for manipulation.
Sort	Sort the entries in the ARP Table by IP address.
Refresh	Refresh the screen to reflect the current state of the ARP table.
Add / Update to IP Bind List	<p>IP Address – Enter the IP address to be associated with a MAC address.</p> <p>Mac Address – Enter the MAC address of the LAN client’s network interface.</p> <p>Comment – Optional comment field to identify this IP Address – MAC Address pair.</p>
Add	It allows you to add the one you choose from the ARP table or the IP/MAC address typed in Add and Edit to the table of IP Bind List .
Update	It allows you to edit and modify the selected IP address and MAC address that you create before.
Delete	You can remove any item listed in IP Bind List . Simply click and select the one, and click Delete . The selected item will be removed from the IP Bind List .
IP Bind List	It displays a list for the IP bind to MAC information.
Backup IP Bind List	Click Backup and enter a filename to back up IP Bind List to a file.
Upload From File	Click Browse... to select an IP Bind List backup file. Click Restore to restore the backup and overwrite the existing list.



Info

Before you select Strict Bind, you have to bind one set of IP/MAC address for one PC. If not, no one of the PCs can access into Internet. And the web user interface of the router might not be accessed.

When you finish the configuration, click **OK** to save the settings.

II-3-4 Port Mirror/Package Capture

The LAN Port Mirror function allows network traffic of select LAN ports to be forwarded to another LAN port for analysis. This is useful for enforcing policies, detecting unauthorized access, monitoring network performance, etc.

Select LAN>>LAN Port Mirror from the menu bar of the Web UI to bring up the LAN Port Mirror configuration page.

If selecting "Continuously Send All Packets to Mirror Port", the setting page will be shown as follows:

LAN >> Port Mirror/Package Capture

Continuously Send All Packets to Mirror Port
 Download .pcap

Enable Disable

	P1 WAN1	P2 LAN	P3 WAN3	P4 LAN	P5 WAN5	P6 WAN6	P7 WAN7	P8 WAN8	P9 LAN	P10 LAN	P11 LAN	P12 LAN
Mirror Port		<input type="radio"/>		<input type="radio"/>					<input type="radio"/>	<input type="radio"/>	<input type="radio"/>	<input checked="" type="radio"/>
Mirrored Tx Port	<input type="checkbox"/>	<input type="checkbox"/>	<input type="checkbox"/>	<input type="checkbox"/>	<input type="checkbox"/>	<input type="checkbox"/>	<input type="checkbox"/>	<input type="checkbox"/>	<input type="checkbox"/>	<input type="checkbox"/>	<input type="checkbox"/>	<input type="checkbox"/>
Mirrored Rx Port	<input type="checkbox"/>	<input type="checkbox"/>	<input type="checkbox"/>	<input type="checkbox"/>	<input type="checkbox"/>	<input type="checkbox"/>	<input type="checkbox"/>	<input type="checkbox"/>	<input type="checkbox"/>	<input type="checkbox"/>	<input type="checkbox"/>	<input type="checkbox"/>
Mirrored VPN	<input type="checkbox"/> All <input type="checkbox"/> LAN to LAN profile <input type="text" value="None"/> <input type="checkbox"/> Remote Dial-in User <input type="text" value="None"/>											

OK

Available settings are explained as follows:

Item	Description
Continuously Send All Packets to Mirror Port	Select to send all packets to mirror port.
Enable/Disable	Select Enable to activate the function. Select Disable to cancel the function.
Mirror Port	One and only one port is selected as the mirror port, to which traffic is to be forwarded.
Mirrored Tx Port	Port(s) whose outbound traffic will be forwarded to the mirror port.
Mirrored Rx Port	Port(s) whose inbound traffic will be forwarded to the mirror port.
Mirrored VPN	VPN(s) that the incoming and outgoing packets will be forwarded to the mirror VPN. All - The packets within all VPN tunnels will be forwarded to the mirror port selected above. LAN to LAN - The packets within the selected LAN to LAN VPN tunnel will be forwarded to the mirror port selected above. Remote Dial-in User - The packets passing through the specified remote dial-in account will be forwarded to the mirror port selected above.
OK	Save the settings.

If selecting "Download .pcap", the setting page will be shown as follows:

LAN >> Port Mirror/Packet Capture

Continuously Send All Packets to Mirror Port
 Download .pcap

	P1 WAN1	P2 LAN	P3 WAN3	P4 LAN	P5 WAN5	P6 WAN6	P7 WAN7	P8 WAN8	P9 LAN	P10 LAN	P11 LAN	P12 LAN
Mirror Port		<input checked="" type="radio"/>		<input type="radio"/>					<input type="radio"/>	<input type="radio"/>	<input type="radio"/>	<input type="radio"/>
Mirrored Tx Port	<input type="checkbox"/>	<input type="checkbox"/>	<input type="checkbox"/>	<input type="checkbox"/>	<input type="checkbox"/>	<input type="checkbox"/>	<input type="checkbox"/>	<input type="checkbox"/>	<input type="checkbox"/>	<input type="checkbox"/>	<input type="checkbox"/>	<input type="checkbox"/>
Mirrored Rx Port	<input type="checkbox"/>	<input type="checkbox"/>	<input type="checkbox"/>	<input type="checkbox"/>	<input type="checkbox"/>	<input type="checkbox"/>	<input type="checkbox"/>	<input type="checkbox"/>	<input type="checkbox"/>	<input type="checkbox"/>	<input type="checkbox"/>	<input type="checkbox"/>
Mirrored VPN	<input type="checkbox"/> All <input type="checkbox"/> LAN to LAN profile <input type="text" value="None"/> <input type="button" value="v"/> <input type="checkbox"/> Remote Dial-in User <input type="text" value="None"/> <input type="button" value="v"/>											

Status: IDLE
 Setting Capture All Packets Capture with Filter
 Duration (seconds)

Filter Settings

Protocol
 IP Address
 Port

Available settings are explained as follows:

Item	Description
Download .pcap	Packets coming from the mirrored Tx/Rx Port(s), mirrored VPN can be captured and downloaded periodically (duration).
Mirror Port	One and only one port is selected as the mirror port, to which traffic is to be forwarded.
Mirrored Tx Port	Port(s) whose outbound traffic will be forwarded to the mirror port.
Mirrored Rx Port	Port(s) whose inbound traffic will be forwarded to the mirror port.
Mirrored VPN	VPN(s) that the incoming and outgoing packets will be forwarded to the mirror VPN. All - Capture the packets within all VPN tunnels. LAN to LAN - Capture the packets within the selected LAN to LAN VPN tunnels. Remote Dial-in User - Capture the VPN packets within the specified remote dial-in account.
Setting	Capture All Packets - All packets will be captured for analysis. Capture with Filter - Only the packets filtered by ICMP, TCP, UDP, or TCP/UDP will be captured for analysis.
Duration	Set a period of time for Vigor router to capture the packets.
Filter Settings	It is available only when Capture with Filter is selected. Protocol - Filter the packet by using Any, ICMP, TCP, UDP, and TCP/UDP.

	<p>IP Address - Filter the packet by IP address. If Customized IP is selected, please enter an IP address in the entry box.</p> <p>Port - It is available when TCP, UDP, or TCP/UDP is selected as the Protocol. Select Any or Customize Port. If Customize Port is selected, please enter a port number in the entry box.</p>												
Start	<p>Click to begin the packet capturing.</p> <p>Diagnostics >> Port Mirror/Packet Capture</p> <hr/> <p> <input type="radio"/> Continuously Send All Packets to Mirror Port <input checked="" type="radio"/> Download .pcap </p> <table border="1"> <thead> <tr> <th></th> <th>P1 WAN1</th> <th>P2 WAN2</th> </tr> </thead> <tbody> <tr> <td>Mirror Port</td> <td></td> <td></td> </tr> <tr> <td>Mirrored Tx Port</td> <td><input checked="" type="checkbox"/></td> <td><input checked="" type="checkbox"/></td> </tr> <tr> <td>Mirrored Rx Port</td> <td><input checked="" type="checkbox"/></td> <td><input checked="" type="checkbox"/></td> </tr> </tbody> </table> <p>Status: Capturing </p> <p>Setting <input checked="" type="radio"/> Capture All Packets <input type="radio"/> Capture with Filter</p> <p>Duration <input type="text" value="60"/> (seconds)</p> <p style="text-align: right;"> <input type="button" value="Start"/> <input type="button" value="Stop"/> <input type="button" value="Downl"/> </p>		P1 WAN1	P2 WAN2	Mirror Port			Mirrored Tx Port	<input checked="" type="checkbox"/>	<input checked="" type="checkbox"/>	Mirrored Rx Port	<input checked="" type="checkbox"/>	<input checked="" type="checkbox"/>
	P1 WAN1	P2 WAN2											
Mirror Port													
Mirrored Tx Port	<input checked="" type="checkbox"/>	<input checked="" type="checkbox"/>											
Mirrored Rx Port	<input checked="" type="checkbox"/>	<input checked="" type="checkbox"/>											
Stop	Click to terminate the scanning job.												
Download	Click to download the packet capture result as a file with the file format, .pcap.												

After finishing all the settings here, please click **OK** to save the configuration.

II-3-5 Wired 802.1X

Wired 802.1X provides authentication for clients wishing to connect to the LAN by Ethernet. Only one client can be authenticated on each LAN port.

Select **LAN >> Wired 802.1X** from the menu bar of the Web UI to bring up the **Wired 802.1X** configuration page.

LAN >> Wired 802.1X

Wired 802.1X

LAN 802.1X:			
<input type="checkbox"/> Enable			
Authentication Type: External RADIUS ▼			
802.1X ports:			
<input type="checkbox"/> P9	<input type="checkbox"/> P10	<input type="checkbox"/> P11	<input type="checkbox"/> P12

Note:

1. 802.1X enabled LAN ports only support a single attached device using EAPOL authentication. To authenticate multiple devices through a LAN port you need an 802.1X-capable switch. Then configure 802.1X on the attached switch instead.
2. Please configure **External RADIUS** or **Local 802.1X** for authentication.
3. Authentication by External RADIUS supports PEAP, EAP-TLS and EAP-TTLS.

OK

Available settings are explained as follows:

Item	Description
Enable	Check the box to enable LAN 802.1x function.
Authentication Type	External RADIUS - An external RADIUS server is to be used for 802.1X authentication. Go to Applications >> RADIUS / TACACS+>>External RADIUS to specify the RADIUS server. Local 802.1X - Use the user database on the router to authenticate clients. Go to User Management >> User Profile to set up users by entering user names, passwords and ensure that Local 802.1X service is enabled for the profiles.
802.1X ports	802.1X authentication will be available for the selected LAN ports.

After finishing all the settings here, please click **OK** to save the configuration.

II-3-6 PPPoE Server

LAN users can access into Internet through built-in PPPoE server on Vigor router. PPPoE server is a mechanism which can authenticate LAN users (configured in **User Management>>User Profile**) and prevent ARP attack completely.

LAN >> PPPoE Server

PPPoE Server

PPPoE Server:	<input checked="" type="radio"/> Disable <input type="radio"/> Enable
Primary DNS:	<input type="text" value="0.0.0.0"/>
Secondary DNS:	<input type="text" value="0.0.0.0"/>

OK

Available settings are explained as follows:

Item	Description
PPPoE Server	Enable - Activate the built-in PPPoE Server. Disable - Disable the built-in PPPoE Server.
Primary DNS / Secondary DNS	Type the IP address(es) of Primary /Secondary DNS server for PPPoE Client(s) in LAN.

II-4 NAT

Most ISPs allocate one WAN IP address to each subscriber. In order to simultaneously connect multiple devices to the Internet, a technique called Network Address Translation is employed.

Usually, the router serves as an NAT (Network Address Translation) router. NAT is a mechanism that one or more private IP addresses can be mapped into a single public one. Public IP address is usually assigned by your ISP, for which you may get charged. Private IP addresses are recognized only among internal hosts.

When the outgoing packets destined to some public server on the Internet reach the NAT router, the router will change its source address into the public IP address of the router, select the available public port, and then forward it. At the same time, the router shall list an entry in a table to memorize this address/port-mapping relationship. When the public server response, the incoming traffic, of course, is destined to the router's public IP address and the router will do the inversion based on its table. Therefore, the internal host can communicate with external host smoothly.

The benefit of the NAT includes:

- **Save cost on applying public IP address and apply efficient usage of IP address.** NAT allows the internal IP addresses of local hosts to be translated into one public IP address, thus you can have only one IP address on behalf of the entire internal hosts.
- **Enhance security of the internal network by obscuring the IP address.** There are many attacks aiming victims based on the IP address. Since the attacker cannot be aware of any private IP addresses, the NAT function can protect the internal network.



Info

On NAT page, you will see the private IP address defined in RFC-1918. Usually we use the 192.168.1.0/24 subnet for the router. As stated before, the NAT facility can map one or more IP addresses and/or service ports into different specified services. In other words, the NAT function can be achieved by using port mapping methods.

Web User Interface

Routing
NAT
Port Redirection
Server Load Balance
DMZ Host
Open Ports
Port Triggering
Port Knocking
Fast NAT
ALG
Firewall

II-4-1 Port Redirection

Port Redirection is usually set up for server related service inside the local network (LAN), such as web servers, FTP servers, E-mail servers etc. Most of the case, you need a public IP address for each server and this public IP address/domain name are recognized by all users. Since the server is actually located inside the LAN, the network well protected by NAT of the router, and identified by its private IP address/port, the goal of Port Redirection function is to forward all access request with public IP address from external users to the mapping private IP address/port of the server.

Most ISPs allocate one WAN IP address to each subscriber. In order to simultaneously connect multiple devices to the Internet, a technique called Network Address Translation is employed.

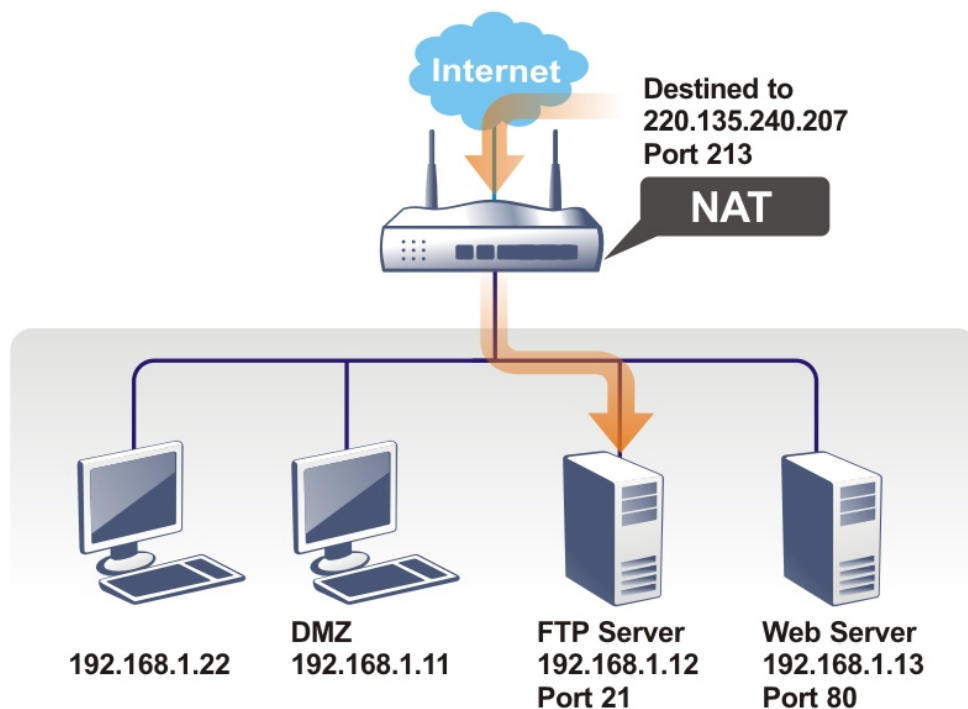

The port redirection can only apply to incoming traffic.

To use this function, please go to NAT page and choose **Port Redirection** web page. The **Port Redirection Table** provides 520 port-mapping entries for the internal hosts.

Port Redirection 50 rules per page | [Set to Factory Default](#) | [Clear selected](#)

Index	Enable	Service Name	WAN Interface	Protocol	Public Port	Source IP	Private IP	Select
1.	<input checked="" type="checkbox"/>	test636	ALL	TCP	2780	Any	192.168.13.10	<input type="checkbox"/>
2.	<input type="checkbox"/>		ALL			Any		<input type="checkbox"/>
3.	<input type="checkbox"/>		ALL			Any		<input type="checkbox"/>
4.	<input type="checkbox"/>		ALL			Any		<input type="checkbox"/>
5.	<input type="checkbox"/>		ALL			Any		<input type="checkbox"/>
6.	<input type="checkbox"/>		ALL			Any		<input type="checkbox"/>
7.	<input type="checkbox"/>		ALL			Any		<input type="checkbox"/>
8.	<input type="checkbox"/>		ALL			Any		<input type="checkbox"/>
9.	<input type="checkbox"/>		ALL			Any		<input type="checkbox"/>
10.	<input type="checkbox"/>		ALL			Any		<input type="checkbox"/>
11.	<input type="checkbox"/>		ALL			Any		<input type="checkbox"/>
12.	<input type="checkbox"/>		ALL			Any		<input type="checkbox"/>

Each item is explained as follows:

Item	Description
Index	Click to view and edit details of the rule.
Enable	Select to enable the port redirection rule.
Service Name	User-entered name that identifies the rule.
WAN Interface	WAN interface(s) to which this rule applies. A particular WAN interface or ALL interfaces.
Protocol	The protocol to which this rule applies, TCP or UDP.
Public Port	The port or range of WAN ports that is redirected by this rule.
Source IP	The IP object of the source IP.
Private IP	The LAN IP address(es) to which the traffic is redirected.
Backup	Click it to backup the configuration of port redirection settings.
Restore	Click it to restore the configuration of port redirection settings. Before clicking, make sure upload the configuration file onto Vigor router.

Press any number under Index to access into next page for configuring port redirection.

NAT >> Port Redirection

Index No. 1

<input checked="" type="checkbox"/> Enable	
Mode	Single ▾
Service Name	ACS
Protocol	TCP ▾
WAN Interface	ALL ▾
Public Port	20011
Source IP	IP Object ▾ None ▾
Private IP	192.168.100.10
Private Port	8080

Note:

In "Range" Mode the End IP will be calculated automatically once the Public Port and Start IP have been entered.

OK Clear Cancel

Available settings are explained as follows:

Item	Description
Enable	Select to enable the port redirection setting.
Mode	Allows a single port or a range of ports to be redirected. Single - redirects one single port. Range - redirects a contiguous range of ports.
Service Name	Enter the description of the specific network service.
Protocol	The protocol to which this rule applies, TCP or UDP.
WAN Interface	WAN interface(s) to which this rule applies. WAN # - Traffic from the selected WAN interface will be redirected. ALL - Traffic from all WAN interfaces will be redirected.
Public Port	Specify which port can be redirected to the specified Private IP and Port of the internal host. If you choose Range as the port redirection mode, you will see two boxes on this field. Enter the required number on the first box (as the starting port) and the second box (as the ending port).
Source IP	IP Object - Use the drop down list to specify an IP object profile. IP Group - Use the drop down list to specify an IP group profile.
Private IP	The LAN IP address or range of IP addresses to which the traffic is redirected. In the case of a range, only the beginning IP address needs to be entered. The ending IP address will automatically be derived from the number of public ports.
Private Port	The port on each LAN client to which the traffic will be directed to.

After finishing all the settings here, please click OK to save the configuration.

Note that the router has its own built-in services (servers) such as Telnet, HTTP and FTP etc. Since the common port numbers of these services (servers) are all the same, you may need to reset the router in order to avoid confliction.

For example, the built-in web user interface in the router is with default port 80, which may conflict with the web server in the local network, http://192.168.1.13:80. Therefore, you need to change the router's http port to any one other than the default port 80 to avoid conflict, such as 8080. This can be set in the System Maintenance >>Management Setup. You then will access the admin screen of by suffixing the IP address with 8080, e.g., http://192.168.1.1:8080 instead of port 80.

System Maintenance >> Management



IPv4 Management Setup	IPv6 Management Setup	LAN Access Setup
Router Name <input type="text" value="Marketing3910"/>		
<input type="checkbox"/> Default:Disable Auto-Logout <input type="checkbox"/> Enable Validation Code in Internet/LAN Access		
Internet Access Control		
<input checked="" type="checkbox"/> Allow management from the Internet Domain name allowed <input type="text"/>		
<input type="checkbox"/> FTP Server <input checked="" type="checkbox"/> HTTP Server <input checked="" type="checkbox"/> Enforce HTTPS Access <input checked="" type="checkbox"/> HTTPS Server <input checked="" type="checkbox"/> Telnet Server <input checked="" type="checkbox"/> TR069 Server <input type="checkbox"/> SSH Server <input type="checkbox"/> SNMP Server <input type="checkbox"/> Disable PING from the Internet		
Access List from the Internet		
<input type="checkbox"/> Apply Access List to PING		
List Type	Index	Description
1	IP Object	None
2	IP Object	None
3	IP Object	None
4	IP Object	None

Management Port Setup	
<input checked="" type="radio"/> User Define Ports <input type="radio"/> Default Ports	
Telnet Port	<input type="text" value="23"/> (Default: 23)
HTTP Port	<input type="text" value="80"/> (Default: 80)
HTTPS Port	<input type="text" value="443"/> (Default: 443)
FTP Port	<input type="text" value="21"/> (Default: 21)
TR069 Port	<input type="text" value="8069"/> (Default: 8069)
SSH Port	<input type="text" value="22"/> (Default: 22)
Note:	
Ports 8001 and 8043 are used for Hotspot Web Portal.	
Brute Force Protection	
<input type="checkbox"/> Enable brute force login protection	
<input type="checkbox"/> FTP Server <input type="checkbox"/> HTTP Server <input type="checkbox"/> HTTPS Server <input type="checkbox"/> Telnet Server <input type="checkbox"/> TR069 Server <input type="checkbox"/> SSH Server <input type="checkbox"/> VPN Server	
Maximum login failures	<input type="text" value="0"/> times

II-4-2 Server Load Balance

This function can avoid excessive load on a single server by distributing the load, optimizing resource usage, and preventing a single server failure.

With this feature enabled, the Vigor router can distribute the inbound NAT sessions among the servers with the configured load balance weight.

NAT >> Server Load Balance

Server Load Balance						Set to Factory Default
Index	Enable	Service Name	WAN Interface	Protocol	Public Port	
1.	<input type="checkbox"/>		ALL	-	-	
2.	<input type="checkbox"/>		ALL	-	-	
3.	<input type="checkbox"/>		ALL	-	-	
4.	<input type="checkbox"/>		ALL	-	-	
5.	<input type="checkbox"/>		ALL	-	-	
6.	<input type="checkbox"/>		ALL	-	-	
7.	<input type="checkbox"/>		ALL	-	-	
8.	<input type="checkbox"/>		ALL	-	-	
9.	<input type="checkbox"/>		ALL	-	-	
10.	<input type="checkbox"/>		ALL	-	-	
11.	<input type="checkbox"/>		ALL	-	-	
12.	<input type="checkbox"/>		ALL	-	-	
13.	<input type="checkbox"/>		ALL	-	-	
14.	<input type="checkbox"/>		ALL	-	-	
15.	<input type="checkbox"/>		ALL	-	-	
16.	<input type="checkbox"/>		ALL	-	-	
17.	<input type="checkbox"/>		ALL	-	-	
18.	<input type="checkbox"/>		ALL	-	-	
19.	<input type="checkbox"/>		ALL	-	-	
20.	<input type="checkbox"/>		ALL	-	-	

Available settings are explained as follows:

Item	Description
Index	Click the link below the number to configure detailed settings.
Enable	Select to enable the profile.
Service Name	Display the name of the profile.
WAN Interface	Display the WAN interface used for accessing the server.
Protocol	Display TCP or UDP used for this profile.
Public Port	Display the port number for the selected WAN interface.

Press any number under Index to access into next page for configuring the profile.

NAT >> Server Load Balance

Index No. 1

<input type="checkbox"/> Enable			
Service Name	<input type="text"/>		
Protocol	TCP ▾		
WAN Interface	ALL ▾		
Public Port	<input type="text" value="0"/>		
Scheduler	Source IP Based ▾		
Private 1 IP/Port/Weight	<input type="text"/>	<input type="text"/>	0 ▾
Private 2 IP/Port/Weight	<input type="text"/>	<input type="text"/>	0 ▾
Private 3 IP/Port/Weight	<input type="text"/>	<input type="text"/>	0 ▾
Private 4 IP/Port/Weight	<input type="text"/>	<input type="text"/>	0 ▾
Private 5 IP/Port/Weight	<input type="text"/>	<input type="text"/>	0 ▾
Private 6 IP/Port/Weight	<input type="text"/>	<input type="text"/>	0 ▾
Private 7 IP/Port/Weight	<input type="text"/>	<input type="text"/>	0 ▾
Private 8 IP/Port/Weight	<input type="text"/>	<input type="text"/>	0 ▾

Available settings are explained as follows:

Item	Description
Enable	Select to enable the profile.
Service Name	Enter a profile name for identification.
Protocol	Select TCP or UDP.
WAN Interface	The client can access the server via this interface (All WAN interfaces or individual WAN#).
Public Port	Enter a port number for the selected WAN interface.
Scheduler	<p>Source IP Based - For ensuring the consistency of user sessions, this function will lead the requests from a specific client (listed on Private# IP/Port/Weight) to the same server. However, it may not distribute traffic evenly once many requests come from the same client.</p> <p>Session Based - This option offers more evenly and effectively distributed traffic by considering IP address, full session details and current load conditions.</p>
Private # IP/Port/Weight	Enter the IPv4 address (x.x.x.x) and port number (1-65535). Select the weight value (0 to 10) for this entry.

After finishing all the settings here, please click **OK** to save the configuration.

II-4-3 DMZ Host

As mentioned above, **Port Redirection** can redirect incoming TCP/UDP or other traffic on particular ports to the specific private IP address/port of host in the LAN. However, other IP protocols, for example Protocols 50 (ESP) and 51 (AH), do not travel on a fixed port. Vigor router provides a facility **DMZ Host** that maps ALL unsolicited data on any protocol to a single host in the LAN. Regular web surfing and other such Internet activities from other clients will continue to work without inappropriate interruption. **DMZ Host** allows a defined internal user to be totally exposed to the Internet, which usually helps some special applications such as Netmeeting or Internet Games etc.

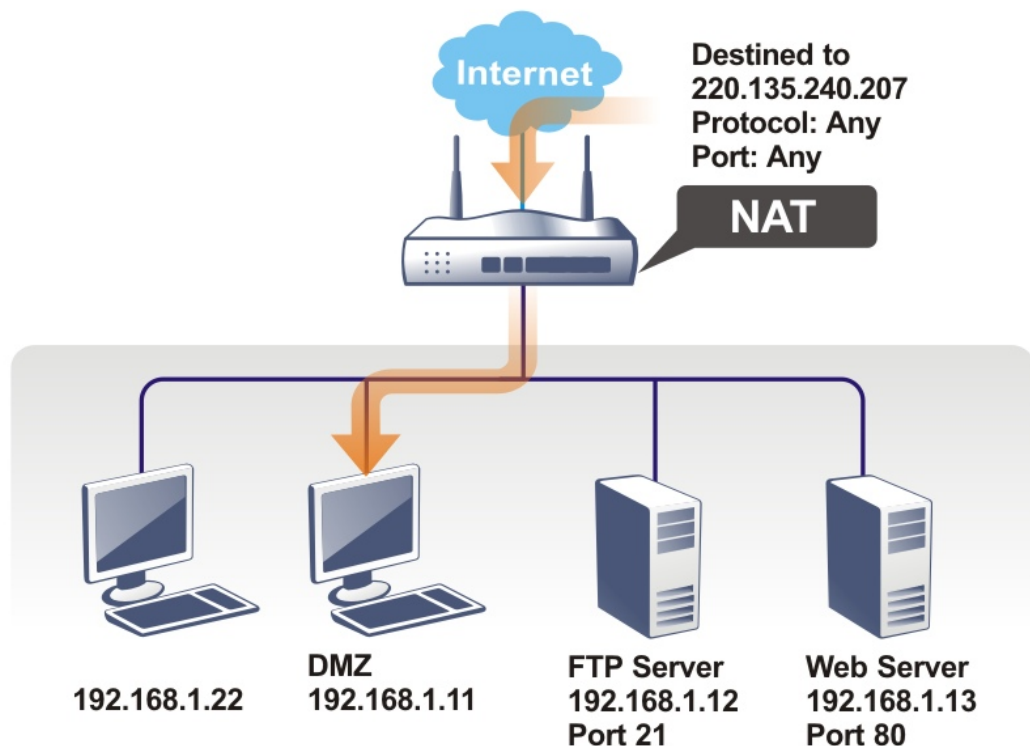

The security properties of NAT are somewhat bypassed if you set up DMZ host. We suggest you to add additional filter rules or a secondary firewall.

Click **DMZ Host** to open the following page. You can set different DMZ host for each WAN interface. Click the WAN tab to switch into the configuration page for that WAN.

NAT >> DMZ Host Setup

DMZ Host Setup

WAN1	WAN3	WAN5	WAN6	WAN7	WAN8
WAN 1					
None					
Private IP					
<input type="text"/>					
Choose IP					

OK

Available settings are explained as follows:

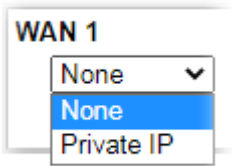
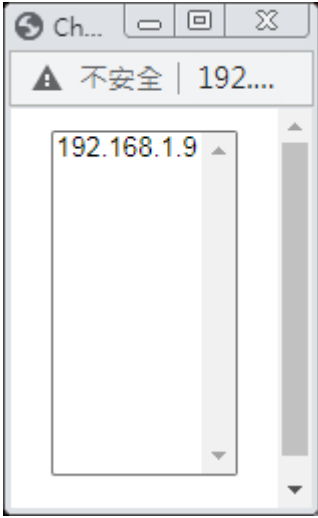
Item	Description
	<p>Enables or disables DMZ host.</p> <p>None - Disables DMZ host function.</p> <p>Private IP - Allows WAN traffic to be sent to a specific LAN IP address.</p>
Private IP	If Private IP mode has been selected, click the Choose IP button to select a LAN IP address.
Choose IP	<p>Click this button and then a window will automatically pop up, as depicted below. The window consists of a list of private IP addresses of all hosts in your LAN network. Select one private IP address in the list to be the DMZ host.</p>  <p>When you have selected one private IP from the above dialog, the IP address will be shown on the screen. Click OK to save the setting.</p>

DMZ Host for other WAN interface is slightly different with WAN1. Active True IP selection is available for WAN1 only.

See the following figure.

NAT >> DMZ Host Setup



If you previously have set up WAN Alias for PPPoE or Static or Dynamic IP mode in WAN2 interface, you will find them in Aux. WAN IP for your selection.

NAT >> DMZ Host Setup

DMZ Host Setup

WAN1		WAN3	WAN5	WAN6	WAN7	WAN8
WAN 1						
Index	Enable	Aux. WAN IP	Private IP			
1.	<input type="checkbox"/>	---	0.0.0.0 <input type="button" value="Choose IP"/>			
2.	<input type="checkbox"/>	192.168.1.56	0.0.0.0 <input type="button" value="Choose IP"/>			

Available settings are explained as follows:

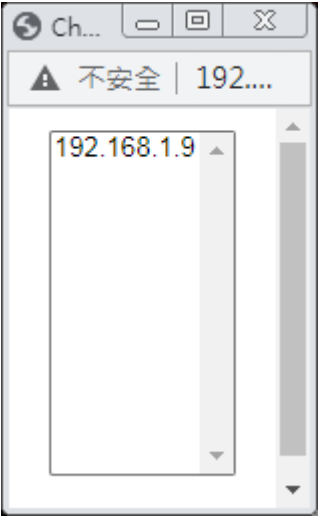
Item	Description
Enable	Check to enable the DMZ Host function.
Private IP	Enter the private IP address of the DMZ host, or click Choose PC to select one.
Choose IP	<p>Click this button and then a window will automatically pop up, as depicted below. The window consists of a list of private IP addresses of all hosts in your LAN network. Select one private IP address in the list to be the DMZ host.</p>  <p>When you have selected one private IP from the above dialog, the IP address will be shown on the screen. Click OK to save the setting.</p>

After finishing all the settings here, please click **OK** to save the configuration.

II-4-4 Open Ports

The Open Ports function allows inbound traffic from specific ports on WAN interfaces to be forwarded to LAN clients. Unlike Port Redirection, LAN client ports cannot be remapped and must remain identical to the opened ports on the WAN interface.

It allows you to open a range of ports for the traffic of special applications.

The common application of Open Ports includes P2P application (e.g., BT, KaZaA, Gnutella, WinMX, eMule, and others), Internet Camera, etc. Ensure that you keep the application involved up-to-date to avoid falling victim to any security exploits.

NAT >> Open Ports

Open Ports Setup 50 rules per page | [Set to Factory Default](#) | [Clear selected](#)

Index	Enable	Comment	WAN Interface	Source IP	Local IP Address	select
1.	<input type="checkbox"/>			Any		<input type="checkbox"/>
2.	<input type="checkbox"/>			Any		<input type="checkbox"/>
3.	<input type="checkbox"/>			Any		<input type="checkbox"/>
4.	<input type="checkbox"/>			Any		<input type="checkbox"/>
5.	<input type="checkbox"/>			Any		<input type="checkbox"/>
6.	<input type="checkbox"/>			Any		<input type="checkbox"/>
7.	<input type="checkbox"/>			Any		<input type="checkbox"/>
8.	<input type="checkbox"/>			Any		<input type="checkbox"/>
9.	<input type="checkbox"/>			Any		<input type="checkbox"/>
10.	<input type="checkbox"/>			Any		<input type="checkbox"/>
11.	<input type="checkbox"/>			Any		<input type="checkbox"/>
12.	<input type="checkbox"/>			Any		<input type="checkbox"/>
13.	<input type="checkbox"/>			Any		<input type="checkbox"/>
14.	<input type="checkbox"/>			Any		<input type="checkbox"/>

Available settings are explained as follows:

Item	Description
Index	Indicate the relative number for the particular entry (1 to 260) that you want to offer service in a local host. Click to view and edit the rule.
Enable	Select the box to enable the open port rule.
Comment	User-entered label that identifies the rule.
WAN Interface	The WAN port(s) whose incoming traffic will be forwarded to a LAN client.
Aux. WAN IP	Display the IP alias setting used by such index. If no IP alias setting exists, this field will not appear.
Source IP	The IP object of the source IP.
Local IP Address	LAN client to receive the forwarded WAN traffic.

To add or edit port settings, click one index number on the page. The index entry setup page will pop up. In each index entry, you can specify 10 port ranges for diverse services.

Index No. 1

<input checked="" type="checkbox"/> Enable Open Ports							
Comment	<input type="text"/>						
WAN Interface	ALL ▾						
Source IP	Any ▾						
Private IP	<input type="text"/>	Choose IP					
	Protocol	Start Port	End Port		Protocol	Start Port	End Port
1.	TCP/UDP ▾	<input type="text"/>	<input type="text"/>	2.	TCP/UDP ▾	<input type="text"/>	<input type="text"/>
3.	TCP/UDP ▾	<input type="text"/>	<input type="text"/>	4.	TCP/UDP ▾	<input type="text"/>	<input type="text"/>
5.	TCP/UDP ▾	<input type="text"/>	<input type="text"/>	6.	TCP/UDP ▾	<input type="text"/>	<input type="text"/>
7.	TCP/UDP ▾	<input type="text"/>	<input type="text"/>	8.	TCP/UDP ▾	<input type="text"/>	<input type="text"/>
9.	TCP/UDP ▾	<input type="text"/>	<input type="text"/>	10.	TCP/UDP ▾	<input type="text"/>	<input type="text"/>
<input type="button" value="OK"/> <input type="button" value="Clear"/> <input type="button" value="Cancel"/>							

Available settings are explained as follows:

Item	Description
Enable Open Ports	Select to enable this rule.
Comment	User-entered label that identifies the rule.
WAN Interface	The WAN port(s) whose incoming traffic will be forwarded to a LAN client. Select from a specific WAN interface WAN1 to WAN6, or choose ALL to apply the rule to all WAN interfaces.
WAN IP	Specify the WAN IP address that will be used for this entry. This setting is available when WAN IP Alias is configured.
Source IP	Any - Any IP can be used as the source IP. IP Object - Use the drop down list to specify an IP object profile. IP Group - Use the drop down list to specify an IP group profile.
Private IP	IP address of LAN client to receive the forwarded WAN traffic. Click Choose IP to select. Choose IP - Click this button and, subsequently, a window having a list of private IP addresses of local hosts will automatically pop up. Select the appropriate IP address of the local host in the list.
Protocol	The protocol(s) to which this rule applies. TCP - forward only TCP traffic. UDP - forward only UDP traffic. TCP/UDP - forward both TCP and UDP traffic.
Start Port	The port number of the starting port to be forwarded.
End Port	The port number of the ending port to be forwarded. If only one port is to be forwarded, enter the same port number as the Start Port.

After finishing all the settings here, please click OK to save the configuration.

NAT >> Open Ports

Open Ports Setup 50 rules per page | [Set to Factory Default](#)

Index	Enable	Comment	WAN Interface	Source IP	Local IP Address
1.	<input checked="" type="checkbox"/>	CARR_1	ALL	Any	192.168.1.9
2.	<input type="checkbox"/>			Any	
3.	<input type="checkbox"/>			Any	
4.	<input type="checkbox"/>			Any	
5.	<input type="checkbox"/>			Any	
6.	<input type="checkbox"/>			Any	
7.	<input type="checkbox"/>			Any	

II-4-5 Port Triggering

If you run programs that function as server applications where they expect to receive unsolicited traffic from the WAN, you can set up rules in Port Triggering to detect LAN-to-WAN traffic initiated by those programs, and automatically open up WAN ports to accept incoming traffic and forward it to the LAN client running the server applications.

Port Triggering is a variation of open ports function.

The key difference between "open port" and "port triggering" is:

- Once the OK button is clicked and the configuration has taken effect, "open port" keeps the ports opened forever.
- Once the OK button is clicked and the configuration has taken effect, "port triggering" will only attempt to open the ports once the triggering conditions are met.
- The duration that these ports are opened depends on the type of protocol used. The "default" durations are shown below and these duration values can be modified via telnet commands.

TCP: 86400 sec.

UDP: 180 sec.

IGMP: 10 sec.

TCP WWW: 60 sec.

TCP SYN: 60 sec.

Port Triggering | [Set to Factory Default](#) |

Index	Enable	Comment	Triggering Protocol	Source IP	Triggering Port	Incoming Protocol	Incoming Port
1.	<input type="checkbox"/>			Any			
2.	<input type="checkbox"/>			Any			
3.	<input type="checkbox"/>			Any			
4.	<input type="checkbox"/>			Any			
5.	<input type="checkbox"/>			Any			
6.	<input type="checkbox"/>			Any			
7.	<input type="checkbox"/>			Any			
8.	<input type="checkbox"/>			Any			
9.	<input type="checkbox"/>			Any			
10.	<input type="checkbox"/>			Any			
11.	<input type="checkbox"/>			Any			
12.	<input type="checkbox"/>			Any			
13.	<input type="checkbox"/>			Any			
14.	<input type="checkbox"/>			Any			
15.	<input type="checkbox"/>			Any			
16.	<input type="checkbox"/>			Any			
17.	<input type="checkbox"/>			Any			
18.	<input type="checkbox"/>			Any			
19.	<input type="checkbox"/>			Any			
20.	<input type="checkbox"/>			Any			

<< [1-20](#) | [21-40](#) >> [Next](#) >>

Available settings are explained as follows:

Item	Description
Index	Rule number. Click to view or modify rule settings.
Enable	Select to enable the Port Triggering rule.
Comment	User-entered label that identifies the rule.
Triggering Protocol	The protocol(s) of the outgoing traffic that this rule monitors. TCP- monitor only TCP traffic. UDP- monitor only UDP traffic. TCP/UDP- monitor both TCP and UDP traffic.
Source IP	The IP object of the source IP.
Triggering Port	Display the port of the triggering packets. Outgoing traffic destined for these port numbers will trigger the opening WAN ports to incoming traffic.
Incoming Protocol	Display the protocol for the incoming data of such triggering profile. The protocol(s) of the incoming traffic. TCP- open port(s) to TCP traffic. UDP- open port(s) to UDP traffic. TCP/UDP- open port(s) to both TCP and UDP traffic.
Incoming Port	Display the port for the incoming data.

	Incoming traffic from the WAN destined for these port numbers be forwarded to the LAN client that triggered the rule.
--	---

Click the index number link to open the configuration page.

NAT >> Port Triggering

No. 1

Enable

Service: User Defined ▾

Comment:

Source IP: Any ▾

Triggering Protocol: Any ▾

Triggering Port:

Incoming Protocol: --- ▾

Incoming Port:

Note:
 The Triggering Port and Incoming Port should be input like this :
 123-456,777-789 (legal),123-456,789 (legal), but 123-456-789 (illegal).

Available settings are explained as follows:

Item	Description
Enable	Select to enable the rule.
Service	Select from list of predefined service, or User Defined to manually configure triggering and incoming protocols and ports.
Comment	Enter the text to memorize the application of this rule.
Source IP	Any - Any IP can be used as the source IP. IP Object - Use the drop down list to specify an IP object profile. IP Group - Use the drop down list to specify an IP group profile.
Triggering Protocol	The protocol(s) of the outgoing traffic that this rule monitors. TCP - monitor only TCP traffic. UDP - monitor only UDP traffic. TCP/UDP - monitor both TCP and UDP traffic.
Triggering Port	Outgoing traffic destined for these port numbers will trigger the opening WAN ports to incoming traffic. Enter the port or port range for such triggering profile.
Incoming Protocol	The protocol(s) of the incoming traffic. TCP -open port(s) to TCP traffic. UDP - open port(s) to UDP traffic. TCP/UDP - open port(s) to both TCP and UDP traffic. Select the protocol (TCP, UDP or TCP/UDP) for the incoming data of such triggering profile.
Incoming Port	Incoming traffic from the WAN destined for these port numbers be forwarded to the LAN client that triggered the

	rule. Enter the port or port range for the incoming packets.
--	---

After finishing all the settings here, please click **OK** to save the configuration.

Open Port and Port Triggering Compared

Port Triggering	Open Port
Ports are opened when the triggering condition is met.	<p>Ports are always open on the WAN interface.</p> <p>Opened ports will be closed after predefined durations have elapsed.</p> <p>Default duration values vary depending on the protocol and traffic content:</p> <ul style="list-style-type: none"> ● TCP (all TCP ports, except those that pass HTTP and HTTPS traffic): 86400 seconds ● UDP: 180 seconds ● TCP WWW (TCP ports that engage in HTTP and HTTPS communication): 60 seconds ● TCP SYN: 60 seconds (SYN packets expire after 60 seconds) <p>These values can be changed by using the command line interface (telnet or SSH).</p>

II-4-6 Port Knocking

Port Redirection is one of the typical ways to allow the internal servers to be accessible from the Internet. However, the port might be exposed to the Internet and might be scanned by the malware if it open.

Therefore, a technology which can add an extra layer of protection to the internal servers and protect network services from unauthorized access, Port Knocking.

This page offers up to 32 profiles to configure the server's public IP, first port knock port and 6 digit validation code. Later, the client's computer can establish the network connection securely via a Port Knock tool. After passing the authentication, the client can access the specified server.

NAT >> Port Knocking

Port Knocking | [Set to Factory Default](#) |

Index	Enable	Service Name	WAN	Protocol	Initial Knock	Public Port	Private Node
1.	<input type="checkbox"/>		ALL	-	-	-	-
2.	<input type="checkbox"/>		ALL	-	-	-	-
3.	<input type="checkbox"/>		ALL	-	-	-	-
4.	<input type="checkbox"/>		ALL	-	-	-	-
5.	<input type="checkbox"/>		ALL	-	-	-	-
6.	<input type="checkbox"/>		ALL	-	-	-	-
7.	<input type="checkbox"/>		ALL	-	-	-	-
8.	<input type="checkbox"/>		ALL	-	-	-	-
9.	<input type="checkbox"/>		ALL	-	-	-	-
10.	<input type="checkbox"/>		ALL	-	-	-	-
11.	<input type="checkbox"/>		ALL	-	-	-	-
12.	<input type="checkbox"/>		ALL	-	-	-	-
13.	<input type="checkbox"/>		ALL	-	-	-	-
14.	<input type="checkbox"/>		ALL	-	-	-	-
15.	<input type="checkbox"/>		ALL	-	-	-	-
16.	<input type="checkbox"/>		ALL	-	-	-	-
17.	<input type="checkbox"/>		ALL	-	-	-	-
18.	<input type="checkbox"/>		ALL	-	-	-	-
19.	<input type="checkbox"/>		ALL	-	-	-	-
20.	<input type="checkbox"/>		ALL	-	-	-	-
21.	<input type="checkbox"/>		ALL	-	-	-	-
22.	<input type="checkbox"/>		ALL	-	-	-	-
23.	<input type="checkbox"/>		ALL	-	-	-	-
24.	<input type="checkbox"/>		ALL	-	-	-	-
25.	<input type="checkbox"/>		ALL	-	-	-	-
26.	<input type="checkbox"/>		ALL	-	-	-	-
27.	<input type="checkbox"/>		ALL	-	-	-	-
28.	<input type="checkbox"/>		ALL	-	-	-	-
29.	<input type="checkbox"/>		ALL	-	-	-	-
30.	<input type="checkbox"/>		ALL	-	-	-	-
31.	<input type="checkbox"/>		ALL	-	-	-	-
32.	<input type="checkbox"/>		ALL	-	-	-	-

Available settings are explained as follows:

Item	Description
Index	Profile number. Click to view or modify the profile settings.
Enable	Select to enable the profile. Only the open ports will be at risk of being attacked. So all ports are disabled (closed) in default.
Service Name	Display the name of the profile.
WAN	Display the interface used for accessing Vigor router.
Protocol	Display the protocol for accessing Vigor router.
Initial Knock	Display the initial knock port number.
Public Port	Display the port number used for the selected protocol.
Private Node	Display the IP address of the server.

Click the index number link to open the configuration page.

NAT >> Port Knocking

Index No. 1

Enable

Service Name

Protocol

WAN Interface

Port Knocking Setting:

1st Knock Port ?

TOTP Key



Validation Code

Port Redirect Setting:

Public Port

Private Node :

Idle Timeout (sec)

Available settings are explained as follows:

Item	Description
Enable	Select to enable the profile.
Service Name	Set a profile name.
Protocol	Select TCP or UDP.
WAN Interfac	It allows the user accessing the server by Vigor router's WAN IP.
Port Knocking Setting	1 st Knock Port - Enter a value. Use the default value if you have no idea to enter a new value. Or click the ? mark to

	<p>have more information.</p> <p>TOTP Key - Use the default value. The key will be used for generate a number for two-factor authentication via an Authenticator App.</p> <p>Regenerate - If required, click this button to regenerate a new TOTP Key.</p> <p>Validation Code - Scan the QR code by a mobile with the App, Google Authenticator. Later, enter the six digit code from the mobile to this field.</p> <p>Verify - Click to verify the validation code to the left.</p>
Port Redirect Setting	<p>Public Port - Set a port number for the protocol TCP or UDP.</p> <p>Private Node - Enter an IPv4 address with a port number of a server.</p> <p>Idle Timeout - The default value (usually one hour). After no traffic within this period, the profile will lock, and you need to do port knock again to use it.</p>

After finishing all the settings here, please click **OK** to save the configuration.

II-4-7 Fast NAT

This function allows for establishing a network connection with a built-in acceleration engine. Time can be saved and CPU usage can be reduced.

NAT >> Fast Routing / NAT

Fast Routing / NAT

<input type="checkbox"/> Fast Routing
<input type="checkbox"/> Fast NAT
<input checked="" type="radio"/> Level 1: Basic, ignore Session Limit.
<input type="radio"/> Level 2: Include LV1 and skip Firewall.
<input type="radio"/> Level 3: Include LV2 and bypass DNS.
<input type="checkbox"/> Enable White List (Only specific subnets are allowed)
<input type="checkbox"/> Enable Black List (Exclude these subnets)

Usage:

1. Use hardware fast path to help establish connections with the same source and destination ip.
2. Enable this function to reduce connection time and cpu usage.

Note:

Session limit and firewall port related settings may not work properly.

OK

Available settings are explained as follows:

Item	Description
Fast Routing	If enabled, the routing connection will be accelerated.
Fast NAT	If enabled, the NAT connection will be accelerated. Level 1 to 3 - Select the type of Fast NAT. Each level represents different limit and condition. Enable White List - The fast NAT feature(accelerated) will be applied to the specified IP. <ul style="list-style-type: none">● Item 1 to 8 - Enter the IP address and select the subnet mask. Enable Black List - Forbid to apply the fast NAT feature to the specified IP. <ul style="list-style-type: none">● Item 1 to 8 - Enter the IP address and select the subnet mask.

After finishing all the settings here, please click **OK** to save the configuration.

II-4-8 ALG

ALG means **Application Layer Gateway**. There are two methods provided by Vigor router, RTSP (Real Time Streaming Protocol) ALG and SIP (Session Initiation Protocol) ALG, for processing the packets of voice and video.

RTSP ALG makes RTSP message, RTCP message, and RTP packets of voice and video be transmitted and received correctly via NAT by Vigor router.

However, SIP ALG makes SIP message and RTP packets of voice be transmitted and received correctly via NAT by Vigor router.

NAT >> ALG

ALG (Application Layer Gateway) | [Set to Factory Default](#) |

Enable ALG

<input type="checkbox"/> Enable	Protocol	Listen Port	TCP	UDP
<input type="checkbox"/>	SIP	<input type="text" value="5060"/> (1~65535)	<input checked="" type="checkbox"/>	<input checked="" type="checkbox"/>
<input type="checkbox"/>	RTSP	<input type="text" value="554"/> (1~65535)	<input checked="" type="checkbox"/>	<input checked="" type="checkbox"/>

Available settings are explained as follows:

Item	Description
Enable ALG	Check to enable such function.
Listen Port	Type a port number for SIP or RTSP protocol.
TCP	Check the box to make correspond protocol message packet from TCP transmit and receive via NAT.
UDP	Check the box to make correspond protocol message packet from UDP transmit and receive via NAT.

II-5 Applications

Dynamic DNS

Most ISPs assigns dynamic WAN IP addresses to their customers. Dynamic IP addresses presents challenges to users who would like to accept remote connections to their LANs from the Internet, as service could be disrupted due to the IP address changing without notice. By setting up service with a Dynamic DNS (DDNS) provider, and configuring Dynamic DNS updates on the Vigor router, you can have reliable access to your network by means of an easy-to-remember domain address that resolves to the most current WAN IP address.

The Vigor router supports a wide range of DDNS providers, such as DynDNS, No-IP.com, DtDNS, and ChangeIP. Please contact the DDNS provider of your choice to set up service before configuring DDNS on the router.

LAN DNS / DNS Forwarding

LAN DNS allows the network administrator to override standard DNS resolutions for selecting domain addresses. The router will respond to queries on matched domain addresses with custom IP addresses.

DNS Forwarding allows the network administrator to forward DNS queries to different DNS servers based on the domain name.

LAN DNS and DNS Forwarding only affect DNS queries that are sent to the WAN through the router. DNS queries that are directed to a DNS server on the LAN will not be intercepted by the router.

Schedule

The Vigor router has a built-in clock which can update itself manually or automatically by means of Network Time Protocols (NTP). As a result, you can not only schedule the router to dialup to the Internet at a specified time, but also restrict Internet access to certain hours so that users can connect to the Internet only during certain hours, say, business hours. The schedule is also applicable to other functions.

RADIUS/TACACS+

Remote Authentication Dial-In User Service (RADIUS) is a security authentication client/server protocol that supports authentication, authorization and accounting, which is widely used by Internet service providers. It is the most common method of authenticating and authorizing dial-up and tunneled network users.

The built-in RADIUS client feature enables the router to assist the remote dial-in user or a wireless station and the RADIUS server in performing mutual authentication. It enables centralized remote access authentication for network management.

LDAP /Active Directory Setup

Lightweight Directory Access Protocol (LDAP) is a communication protocol for using in TCP/IP network. It defines the methods to access distributing directory server by clients, work on directory and share the information in the directory by clients. The LDAP standard is established by the work team of Internet Engineering Task Force (IETF).

As the name described, LDAP is designed as an effect way to access directory service without the complexity of other directory service protocols. For LDAP is defined to perform, inquire and modify the information within the directory, and acquire the data in the directory securely, therefore users can apply LDAP to search or list the directory object, inquire or manage the active directory.

UPnP

The Vigor supports UPnP (Universal Plug and Play), which is a suite of network protocols that simplifies network configuration. Applications and network devices on the LAN, that support UPnP, may request the router to modify its settings to allow NAT Traversal, so that WAN hosts can connect to them directly.

Examples of applications and devices that support UPnP include file-sharing applications such as uTorrent, Vuze and eMule, gaming consoles such as the Sony PlayStations 3 and 4 Xbox 360 and Xbox One, media streaming applications such as Plex and XBMC, and messaging and calling applications such as Skype. To find out if a certain application or network device supports or requires UPnP, please consult its user manual or check with its vendor.

Wake on LAN

Using the Wake on LAN (WoL) feature, LAN clients that support WoL can be powered on or resume from sleep over the network, without the need for physical access to the device.

In order for LAN clients to be able to woken from sleep or off states, the network interface card must be configured to monitor Wake-on-LAN messages. Consult the documentation of the LAN client for details on setting up its network interface for Wake on LAN.

Web User Interface

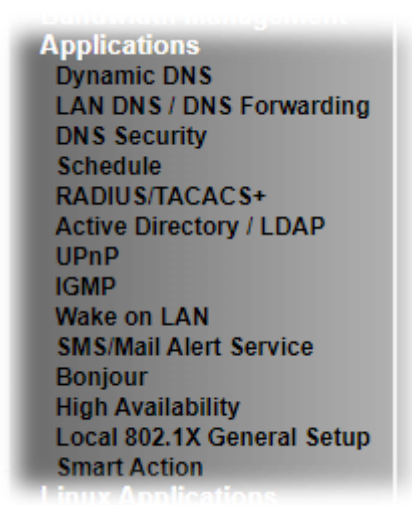

II-5-1 Dynamic DNS

Enable the Function and Add a Dynamic DNS Account

To begin configuring Dynamic DNS, from the main menu, navigate to **Applications**, and select **Dynamic DNS**. The Dynamic DNS main configuration screen appears:

Applications >> Dynamic DNS Setup

| [Set to Factory Default](#) |

Enable Dynamic DNS Setup

Auto-Update interval Min(s) (180~14400)

Accounts:

Index	Enable	WAN Interface	Domain Name
1.	<input checked="" type="checkbox"/>	WAN1 First	
2.	<input type="checkbox"/>	WAN1 First	
3.	<input type="checkbox"/>	WAN1 First	
4.	<input type="checkbox"/>	WAN1 First	
5.	<input type="checkbox"/>	WAN1 First	
6.	<input type="checkbox"/>	WAN1 First	

Available settings are explained as follows:

Item	Description
Enable Dynamic DNS Setup	Select to enable DDNS function.
Set to Factory Default	Click to clear all profiles to factory settings.
View Log	Select to display the most recent DDNS update messages.
Force Update	Click to connect immediately to DDNS servers to update IP address information.

Auto-Update interval	The frequency, in minutes, at which the router connects to DDNS servers to update IP address information.
Index	Click to bring up the configuration page of the DDNS profile.
Enable	Check the box to enable such account.
WAN Interface	Shows the WAN interface associated with the DDNS profile.
Domain Name	Shows the domain name with which the profile is associated.

After clicking on the index number, the detail configuration screen for the DDNS profile appears:

Applications >> Dynamic DNS Setup >> Dynamic DNS Account Setup

Index : 1

Enable Dynamic DNS Account

WAN Interface:

Service Provider:

Service Type:

Domain Name:

Login Name:

Password:

Wildcards

Backup MX

Mail Extender:

Determine WAN IP:

Let's Encrypt certificate

Status:

Auto Renew:

Note:

1. The Create function of Let's Encrypt certificate works only when the current profile has been stored.
2. WAN IP must be public IP when create Let's Encrypt certificate.

If User-Defined is specified as the service provider, the web page will be changed slightly as follows:

Index : 1

Enable Dynamic DNS Account

WAN Interface: WAN1 First

Service Provider: User-Defined

Provider Host: changeip.org

Service API: /dynamic/dns/update.asp?
u=joe&p=joe&hostname=joe.changeip.org&ip=##IP##&c
md=update&offline=0

Auth Type: basic

Connection Type: Http

Server Response:

Login Name: chronic6653 (max. 64 characters)

Password: (max. 23 characters)

Wildcards

Backup MX

Mail Extender:

Determine Real WAN IP: Internet IP

OK Clear Cancel

Available settings are explained as follows:

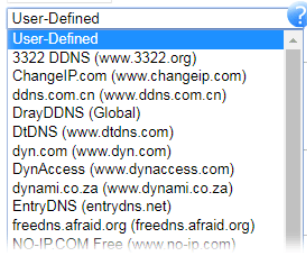
Item	Description
Enable Dynamic DNS Account	Select to enable this DDNS profile.
WAN Interface	Select the WAN interface to monitor for IP address changes. WANx First - The specified WAN interface will be examined first. If it is online, its IP address will be used in the DDNS update. WANx Only - Only the specified WAN interface will be examined. If the WAN interface is online, its IP address will be used in the DDNS update. Otherwise no update will be performed for this DDNS profile.
Service Provider	Select the DDNS provider. If your DDNS provider is not listed, select User-Defined and manually configure the profile.  <ul style="list-style-type: none"> ● Provider Host - Enter the IP address or the domain name of the host which provides related service. Note that such option is available when Customized is selected as Service Provider. ● Service API - Enter the API information obtained from DDNS server. Note that such option is available when Customized is

	<p>selected as Service Provider.</p> <p>(e.g: /dynamic/dns/update.asp?u=jo***&p=jo*****&hostname=j****.changeip.org&ip=###IP###&cmd=update&offline=0)</p> <ul style="list-style-type: none"> ● Auth Type - Two types can be used for authentication. <ul style="list-style-type: none"> Basic - Username and password defined later can be shown from the packets captured. URL - Username and password defined later can be shown in URL. (e.g., http://ns1.vigorddns.com/ddns.php?username=xxx&password=xxx&domain=xxx.vigorddns.com) <p>Note that such option is available when Customized is selected as Service Provider.</p> ● Connection Type - There are two connection types (HTTP and HTTPS) to be specified. Note that such option is available when Customized is selected as Service Provider. ● Server Response - Type any text that you want to receive from the DDNS server. Note that such option is available when Customized is selected as Service Provider. <p>If other service provider is selected, you have to configure Service Type, Domain Name, Login Name and Password.</p> <ul style="list-style-type: none"> ● Service Type - Select the service type that matches that of your DynDNS account. If you are unsure which service type to select, try Dynamic first. This options is applicable to DynDNS only. ● Domain Name - The domain and subdomain to be updated.
Login Name	The login name of the DDNS account.
Password	The password of the DDNS account.
Wildcard and Backup MX	The Wildcard and Backup MX (Mail Exchange) features are not supported for all Dynamic DNS providers. You could get more detailed information from their websites.
Mail Extender	If the mail server is defined with another name, please enter the name in this area. Such mail server will be used as backup mail exchange.
Determine WAN IP	<p>If a Vigor router is installed behind any NAT router, you can enable such function to locate the real WAN IP.</p> <p>When the WAN IP used by Vigor router is private IP, this function can detect the public IP used by the NAT router and use the detected IP address for DDNS update.</p> <p>There are two methods offered for you to choose:</p> <ul style="list-style-type: none"> ● WAN IP - The IP address of the router's WAN interface will be used. ● Internet IP - The real public IP address will be used. Select this option if the IP address assigned to the router's WAN interface is not the actual external IP address.
Let's Encrypt certificate	<p>Create - Click it to generate a certificate issued by Let's Encrypt for applying to such DDNS account.</p> <p>Auto Renew- Check the box to make the system update the</p>

certificate automatically.

Click **OK** to save changes, **Clear** to clear all settings, or **Cancel** to discard changes and return to the main DDNS screen.

DrayDDNS Settings

DrayDDNS, a new DDNS service developed by DrayTek, can record multiple WAN IP (IPv4) on single domain name. It is convenient for users to use and easily to set up. Each Vigor Router is available to register one domain name.

Choose **DrayTek Global** as the service provider, the web page will be displayed as follows:

Applications >> Dynamic DNS Setup >> Dynamic DNS Account Setup

Index : 1

<input checked="" type="checkbox"/> Enable Dynamic DNS Account	
Service Provider	DrayDDNS (Global) <input type="button" value="View Log"/>
Status	[Status:Activated][Provider:DT-DDNS] [Start Date:2020-10-25 Expire Date:2021-10-25]
Domain Name	garytest .drayddns.com <input type="button" value="Edit domain"/>
Determine WAN IP	WAN IP <input checked="" type="checkbox"/> IPv4 <input type="checkbox"/> IPv6
WAN Interfaces	<input type="checkbox"/> WAN 1 <input checked="" type="checkbox"/> WAN 3 <input checked="" type="checkbox"/> WAN 5 <input type="checkbox"/> WAN 6 <input type="checkbox"/> WAN 7 <input type="checkbox"/> WAN 8 <input type="checkbox"/> Alias IP in Service Status Setup
Let's Encrypt certificate	
Status	Signed [Valid To: Mar 11 02:07:28 2021 GMT]
Auto Renew	<input type="checkbox"/>

Available settings are explained as follows:

Item	Description
Enable Dynamic DNS Account	Check this box to enable the current account. If you did check the box, you will see a check mark appeared on the Active column of the previous web page in step 2).
Service Provider	Choose DrayTek Global as the service provider.
Status	Display if the license is actvtaed or not.
Domain Name	The domain and subdomain to be updated.
Determine WAN IP	If a Vigor router is installed behind any NAT router, you can enable such function to locate the real WAN IP. When the WAN IP used by Vigor router is private IP, this function can detect the public IP used by the NAT router and use the detected IP address for DDNS update. There are two methods offered for you to choose: <ul style="list-style-type: none">● WAN IP - If it is selected and the WAN IP of Vigor router is private, DDNS update will take place right away.● Internet IP - If it is selected and the WAN IP of Vigor router is private, it will be converted to public IP before DDNS update takes place.
WAN Interfaces	WANx - While connecting, the router will use WANx as the channel for such account.
Let's Encrypt certificate	Auto Renew - Check the box to make the system update the certificate automatically.

Disable the Function and Clear all Dynamic DNS Accounts

In the DDNS setup menu, uncheck **Enable Dynamic DNS Setup**, and push **Clear All** button to disable the function and clear all accounts from the router.

Delete a Dynamic DNS Account

In the DDNS setup menu, click the **Index** number you want to delete and then push **Clear All** button to delete the account.

DDNS updates take place when:

- The router is powered on or rebooted.
- The public IP address of any WAN interface changes.
- The online status of a WAN interface changes (going from online to offline or vice versa).
- The DDNS function is changed from disabled to enabled.
- A DDNS entry is modified and enabled.
- The Auto-Update Interval has elapsed.

Procedures for Setting up a Dynamic DNS Entry

1. Contact the dynamic DNS provider of your choice and have service set up. Most DDNS providers accept signups on their websites. Service could be provided free of charge or for a fee.
2. Create a DDNS entry on the router by selecting the appropriate DDNS provider and enter the account information.
3. Make sure that both the DDNS entry and the DDNS feature are enabled on the router.
4. Click the View Log button on the DDNS main page to bring up the update log.
5. Examine the update log to make sure the update was successful.
6. If the update was not successful, verify the DDNS entry to make sure the settings are entered correctly.

II-5-2 LAN DNS / DNS Forwarding

The LAN DNS lets the network administrators host servers with privacy and security. When the network administrators of your office set up FTP, Mail or Web server inside LAN, you can specify specific private IP address (es) to correspondent servers. Thus, even the remote PC is adopting public DNS as the DNS server, the LAN DNS resolution on Vigor3912 Series will respond the specified private IP address.

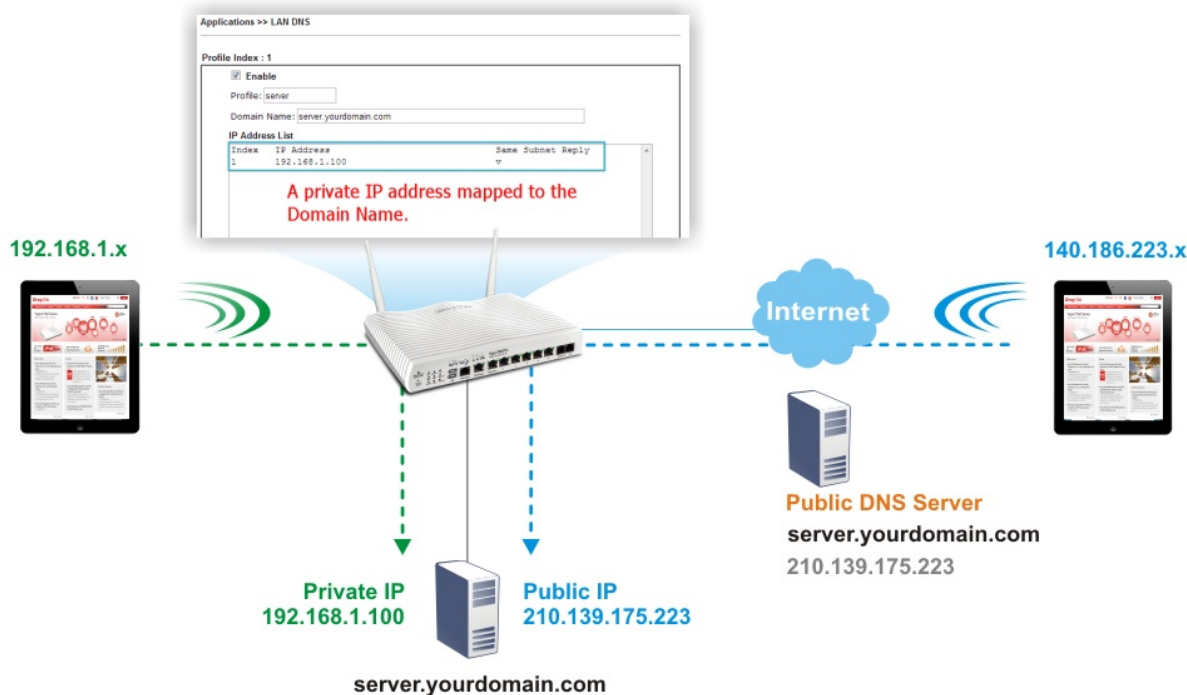

To start configuring LAN DNS or DNS Forwarding, from the main menu, click **Applications**, followed by **LAN DNS / DNS Forwarding**.

Applications >> LAN DNS / DNS Forwarding



LAN DNS Resolution / Conditional DNS Forwarding

[Set to Factory Default](#)

Index	Enable	Profile	Domain Name	Type	DNS Server
1.	<input type="checkbox"/>			-	
2.	<input type="checkbox"/>			-	
3.	<input type="checkbox"/>			-	
4.	<input type="checkbox"/>			-	
5.	<input type="checkbox"/>			-	
6.	<input type="checkbox"/>			-	
7.	<input type="checkbox"/>			-	
8.	<input type="checkbox"/>			-	
9.	<input type="checkbox"/>			-	
10.	<input type="checkbox"/>			-	

<< 1-10 | 11-20 | 21-30 | 31-40 | 41-50 | 51-60 | 61-70 | 71-80 | 81-90 | 91-100 | 101-110 | 111-120 >>

OK

Each item is explained as follows:

Item	Description
Set to Factory Default	Click to clear all profiles to factory settings.
Index	Click to bring up the configuration page for the profile.
Enable	Select to enable this profile.
Profile	Shows the name of the profile.
Domain Name	Shows the domain name configured for the profile.
Type	Displays the type (LAN DNS or DNS Forwarding) of the profile.
DNS Server	DNS server to which DNS queries for the specified domain name will be forwarded.

To configure a LAN DNS profile, click on its index to bring up the configuration page.

Profile Index : 1

Enable

Profile:

Type:

Domain Name:

Note:

1. Support wildcard subdomain, ex: *.example.com
2. One domain Name has only one IPv4 address and IPv6 address in the same subnet.

CNAME(Alias Domain Name):

IP Address List (Max. 40 entries)

Index	IP Address	Same Subnet	Reply
1	192.168.1.56	v	

Available settings are explained as follows:

Item	Description
Enable	Select to enable this profile.
Profile	Enter a name to identify this profile. Note: If you type a name here for LAN DNS and click OK to save the configuration, the name also will be applied to conditional DNS forwarding automatically.
Type	Choose LAN DNS or LAN Forwarding.
If LAN DNS is selected	<p>Domain Name - Enter the domain name for the router to look for in DNS queries to intercept and reply to. Wildcards in the form of asterisks (*) can be used to match a domain level. For example, *.draytek.com will match domain names such as www.draytek.com and ftp.draytek.com, whereas www.draytek.* will match domain names such as www.draytek.com and www.draytek.co.uk.</p> <p>CNAME - Add a domain name alias for the domain name.</p> <p>IP Address List - The IP address listed here will be used for mapping with the domain name specified above. In general, one domain name maps with one IP address. If required, you can configure two IP addresses mapping with the same domain name.</p> <p>Add -Click Add to bring up the Add IP Address dialog box:</p>

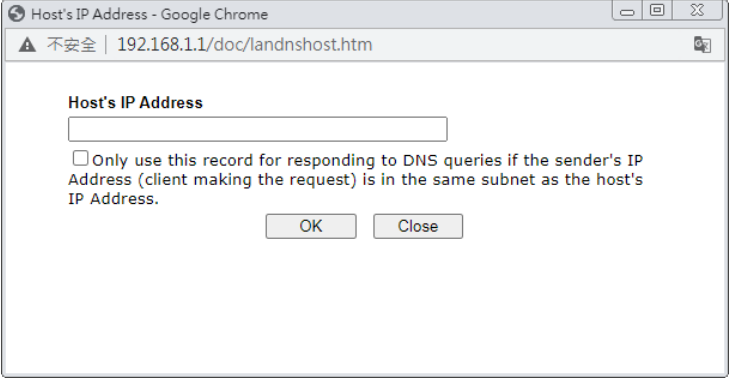
	 <ul style="list-style-type: none"> ● Host's IP Address - Enter the IP address to be returned in response to a DNS query for the configured domain names and aliases. ● Only use this record... - Select to use this IP address only if the IP address of the source of the DNS query belongs to the same subnet as the host IP address entered above. <p>After changes have been made, click OK to save and dismiss the dialog box, or Close to discard the changes and dismiss the dialog box.</p> <p>Delete -To delete an IP address, click on it and then click Delete.</p>
<p>If DNS Forwarding is selected</p>	<p>Domain Name - Enter the domain name for the router to look for in DNS queries to intercept and reply to. Wildcards in the form of asterisks (*) can be used to match a domain level. For example, *.draytek.com will match domain names such as www.draytek.com and ftp.draytek.com, whereas www.draytek.* will match domain names such as www.draytek.com and www.draytek.co.uk.</p> <p>DNS Server IP Address - Enter the IP address of the DNS server you want to use for DNS forwarding.</p>

To save changes made to the LAN DNS profile, click **OK**. To clear the profile and restore the factory default blank values, click **Clear**.

II-5-3 DNS Security

Domain Name System Security Extensions (DNSSEC) protects against DNS-based attacks by authenticating DNS responses from DNS resolvers.

The DNS servers must support DNS security validation for the feature to function properly.

To configure DNS security, from the main menu, click **Applications**, followed by **DNS Security**.

II-5-3-1 General Setup

All of WAN interfaces of Vigor router can be configured with DNS Security enabled respectively.

Application >> DNS Security



DNS Security

General Setup		Domain Diagnosis		Refresh
Interface	Enable	Primary DNS	Secondary DNS	Bogus DNS Reply
WAN1	<input type="checkbox"/>	---	---	Pass ▼
WAN3	<input type="checkbox"/>	---	---	Pass ▼
WAN5	<input type="checkbox"/>	---	---	Pass ▼
WAN6	<input type="checkbox"/>	---	---	Pass ▼
WAN7	<input type="checkbox"/>	---	---	Pass ▼
WAN8	<input type="checkbox"/>	---	---	Pass ▼

Note:



The DNS server supports DNSSEC



The DNS server does not support DNSSEC, function may not work as expected even if it is enabled

OK

Available settings are explained as follows:

Item	Description
Interface	The WAN interface name for which DNS security is to be configured.
Enable	Select to enable DNS security for this WAN Interface.
Primary DNS	Shows the primary DNS server IP address in effect for this WAN.
Secondary DNS	Shows the secondary DNS server IP address in effect for this WAN.
Bogus DNS Reply	Show action to be taken for DNS responses that fail authentication. Choose Pass or Drop. Pass - Pass DNS result. Drop - Do not pass DNS result.

Press OK to save changes.

II-5-3-2 Domain Diagnose

While using the Domain Diagnose feature, you can check to see if the router's DNS security function is working properly, or whether a given domain is secured by DNS security. Note that DNS Security has to be first enabled or the test results would not be meaningful.

Application >> DNS Security



DNS Security

General Setup | **Domain Diagnosis** | [DNS Cache](#)

Domain: IPv4 IPv6

Interface:

DNS Server:

Note:
If the domain has not been queried before, it will take a few seconds to process.

Result | [Clear](#) |

Domain Name	IP Address	Interface	Verify Result

Available settings are explained as follows:

Item	Description
Domain	Enter domain address to be diagnosed. Select the type of IP address to be looked up. IPv4 - looks up A records. IPv6 - looks up AAAA records.
Interface	Select the WAN port to be used for the lookup.
DNS Server	Enter the IPv4 address of the DNS server to be used for the lookup.
Diagnose	Click to begin DNS lookup.
Result	The history of domain diagnosis is shown in the Result panel.

II-5-4 Schedule

Time schedules can be created and used with router features that support them, so that those features can be turned on and off automatically at preconfigured times.

Applications >> Schedule

Schedule : Current System Time
 2020 Dec 29 Tue 6 : 27 : 40 | [System time set](#) | [Set to Factory Default](#) |

Index	Enable	Comment	Time	Frequency
1	<input type="checkbox"/>			Sun.
2	<input type="checkbox"/>			Sun.
3	<input type="checkbox"/>			Sun.
4	<input type="checkbox"/>			Sun.
5	<input type="checkbox"/>			Sun.
6	<input type="checkbox"/>			Sun.
7	<input type="checkbox"/>			Sun.
8	<input type="checkbox"/>			Sun.
9	<input type="checkbox"/>			Sun.
10	<input type="checkbox"/>			Sun.
11	<input type="checkbox"/>			Sun.
12	<input type="checkbox"/>			Sun.
13	<input type="checkbox"/>			Sun.
14	<input type="checkbox"/>			Sun.
15	<input type="checkbox"/>			Sun.

■ Force on ■ Force down

OK

Available settings are explained as follows:

Item	Description
Current System Time	Shows the current time of the router.
System time set	Click to navigate to System Maintenance >> Time and Date to set the system time and date.
Set to Factory Default	Reset all schedules to factory default values.
Index	Shows the index number of the schedule entry.
Enable	Select to enable the schedule; clear to disable it.
Comment	Shows the name given to the schedule.
Time	Shows the start and end times of the schedule. The time interval of the schedule is indicated in dark grey.

Frequency	Shows the days of the week configured for the schedule. Selected days are shown in dark grey. ● - If it lights in green, it means such schedule is active.
-----------	---

To configure a schedule, click on its index to bring up the settings page.

Applications >> Schedule

Index No. 1 Current System Time 2000 Jan 1 Sat 3 : 27 : 41 | System time set |

Enable Schedule Setup

Comment

Start Date (yyyy-mm-dd) --

Start Time (hh:mm) :

Duration Time (hh:mm) :

End Time (hh:mm) :

Action

How Often

Once

Weekdays

Sun Mon Tue Wed Thu Fri Sat

Monthly, on date

Cycle duration: days (Cycle will start on the Start Date.)

Note:

Comment can only contain A-Z a-z 0-9 , . { } - _ () ^ \$! ~ ` |

Available settings are explained as follows:

Item	Description
Enable Schedule Setup	Select to enable the schedule; clear to disable it.
Comment	Name to identify this schedule entry.
Start Date (yyyy-mm-dd)	The date when the entry comes into effect.
Start Time (hh:mm)	The time when the schedule is triggered. See the How Often setting below for details.
Duration Time (hh:mm)	How long the action lasts when the scheduled is triggered.
End Time (hh:mm)	It will be calculated automatically when Start Time and Duration Time are configured well.
Action	Action to take when the schedule is triggered. Force On - The feature with which this schedule is associated will be turned on. Force Down - The feature with which this schedule is associated will be turned off.
How Often	How frequently the schedule is triggered. <ul style="list-style-type: none"> ● Once - The schedule is triggered once, on the Start Date at the Start Time, for the Duration Time. ● Weekdays - The schedule will be triggered repeatedly, starting on the Start Date at the Start Time, on the selected days of the week, at the Start Time, for the Duration Time.

- **Monthly, on date** - The router will only execute the action applied such schedule on the date (1 to 28) of a month.
- **Cycle duration** - Type a number as cycle duration. Then, any action applied such schedule will be executed per several days. For example, "3" is selected as cycle duration. That means, the action applied such schedule will be executed every three days since the date defined on the Start Date.

To save changes made to the Schedule, click **OK**. To clear the schedule and restore the factory default blank values, click **Clear**. To cancel the changes and return to the main Schedule page, click **Cancel**.

Example

Suppose you want to control the PPPoE Internet access connection to be always on (Force On) from 9:00 to 18:00 for whole week. Other time the Internet access connection should be disconnected (Force Down).

Office
Hour:
(Force On)



Mon - Sun 9:00 am to 6:00 pm

1. Make sure the PPPoE connection and **Time Setup** is working properly.
2. Configure the PPPoE always on from 9:00 to 18:00 for whole week.
3. Configure the **Force Down** from 18:00 to next day 9:00 for whole week.
4. Assign these two profiles to the PPPoE Internet access profile. Now, the PPPoE Internet connection will follow the schedule order to perform **Force On** or **Force Down** action according to the time plan that has been pre-defined in the schedule profiles.

II-5-5 RADIUS/TACACS+

Remote Authentication Dial-In User Service (RADIUS) is a security authentication client/server protocol that supports authentication, authorization, and accounting, which is widely used in enterprise networks. It is the most common authentication method to manage the clients' access to the wireless network, the Internet and the VPN.

The router supports external TACACS+ and internal and external RADIUS servers for user authentication. To configure TACACS+ or RADIUS servers, from the Main Menu select **Applications >> RADIUS/TACACS+**.

II-5-5-1 External RADIUS

The built-in RADIUS client feature enables the router to assist the remote dial-in user or a wireless station and the RADIUS server in performing mutual authentication. It enables centralized remote access authentication for network management.

Vigor router can be operated as a RADIUS client. This web page is used to configure settings for external RADIUS server. Then LAN users of Vigor router will be authenticated and accounted by such server for network application.

Select External RADIUS to configure the router to use an external RADIUS server for user authentication.

Applications >> RADIUS/TACACS+

External RADIUS		Internal RADIUS	External TACACS+		
Index	Enable	Comments	Primary Server	Secondary Server	
1.	<input type="checkbox"/>				
2.	<input type="checkbox"/>				
3.	<input type="checkbox"/>				
4.	<input type="checkbox"/>				

Default Profile

RADIUS Request Interval sec (2~30)

OK

Clear

Cancel

RADIUS Server Status Log

Profile | [Refresh](#) | [Clear](#)

Item	Description
Enable	Select to enable the profile.
Comment	Displays the comment of the profile.
Primary Server	Displays the IP address of the primary server.
Secondary Server	Display the IP address of the secondary server.
Default Profile	Select one of the profiles as the default profile for user authentication.
RADIUS Request Interval	Set a timeout value for the router waiting for a response from the RADIUS server. If no response, Vigor router will send the authentication request again.

RADIUS Server Status Log

Display the record of current status of RADIUS server.

Click any index number to open the following page. It is used to configure settings for external RADIUS server. Then users of the Vigor router will be authenticated by this server for the network application.

Applications >> RADIUS/TACACS+ >> Profile 1

<input checked="" type="checkbox"/>	Enable this profile
<input checked="" type="checkbox"/>	Enable Accounting
Comments:	<input type="text"/>
Primary Server	
Primary Server	<input type="text"/>
Secret	<input type="text"/>
Authentication Port	<input type="text" value="1812"/>
Accounting Port	<input type="text" value="1813"/>
Disconnect Message Port	<input type="text" value="3799"/>
Interim Update Interval	<input type="text" value="10"/> min(s)(10~1440)
Retry	<input type="text" value="2"/> times(1~3)
Secondary Server	
Secondary Server	<input type="text"/>
Secret	<input type="text"/>
Authentication Port	<input type="text" value="1812"/>
Accounting Port	<input type="text" value="1813"/>
Disconnect Message Port	<input type="text" value="3799"/>
Interim Update Interval	<input type="text" value="10"/> min(s)(10~1440)
Retry	<input type="text" value="2"/> times(1~3)

Note:

If RADIUS server has specified Interim Update Interval value(Acct-Interim-Interval), Vigor Router will follow the interval that the RADIUS server provides and ignore the Interim Update Interval setting here.

Available settings are explained as follows:

Item	Description
Enable this profile	Check to enable RADIUS client profile. Comment - Enter a brief description for this profile.
Enable Accounting	After checking it, Vigor router supports the accounting feature (available seconds for using, quantity of RX/TX data) for external RADIUS server. Any client tries to access the Internet shall be authenticated and accounted by an external RADIUS server. Accounting Port -The UDP port number that the RADIUS server is using. The default value is 1813, based on RFC 2138. Disconnect Message Port - Set a port number for listening the RADIUS disconnection message. Interim Update Interval - Set a time interval for sending the accounting request to the RADIUS server.

	<p>Applications >> RADIUS/TACACS+ >> Profile 1</p> <div style="border: 1px solid black; padding: 5px;"> <input checked="" type="checkbox"/> Enable this profile <input checked="" type="checkbox"/> Enable Accounting Comments: <input type="text"/> <hr/> Primary Server <hr/> Primary Server <input type="text"/> Secret <input type="text"/> Authentication Port <input type="text" value="1812"/> Accounting Port <input type="text" value="1813"/> Disconnect Message Port <input type="text" value="3799"/> Interim Update Interval <input type="text" value="10"/> min(s)(10~1440) Retry <input type="text" value="2"/> times(1~3) </div>
Primary Server	<p>Primary Server - Enter the IP address of RADIUS server.</p> <p>Secret - The RADIUS server and client share a secret that is used to authenticate the messages sent between them. Both sides must be configured to use the same shared secret. The maximum length of the shared secret you can set is 36 characters.</p> <p>Authentication Port - The UDP port number that the RADIUS server is using. The default value is 1812, based on RFC 2138.</p> <p>Retry - Set the number of attempts to perform reconnection with RADIUS server. If the connection (with the Primary Server) still fails, stop the connection attempt and begin to make connection with the secondary server.</p>
Secondary Server	<p>Secondary Server - Enter the IP address of RADIUS server.</p> <p>Secret - The RADIUS server and client share a secret that is used to authenticate the messages sent between them. Both sides must be configured to use the same shared secret. The maximum length of the shared secret you can set is 36 characters.</p> <p>Authentication Port - The UDP port number that the RADIUS server is using. The default value is 1812, based on RFC 2138.</p> <p>Retry - Set the number of attempts to perform reconnection. If the connection (with the Secondary Server) still fails, stop the connection attempt. The client authentication would be determined as "failed".</p>

To save changes on the page, click **OK**. To discard changes, click **Cancel**. To reset all settings to blank, click **Clear**.

II-5-5-2 Internal RADIUS

Except for being a built-in RADIUS client, Vigor router also can be operated as a RADIUS server which performs security authentication by itself. This page is used to configure settings for internal RADIUS server. Then users of Vigor router will be authenticated by Vigor router directly.

Select Internal RADIUS to configure the router's built-in RADIUS server.

External RADIUS
Internal RADIUS
External TACACS+

Enable

Authentication Port

RADIUS Client Access List

Index	Enable	Shared Secret	IP Address	IP Mask	IPv6 Address	IPv6 Length
1	<input checked="" type="checkbox"/>	***	192.168.100.10	255.255.255.255	::	0
2	<input type="checkbox"/>	Max: 31 character	0.0.0.0	0.0.0.0	::	0
3	<input type="checkbox"/>	Max: 31 character	0.0.0.0	0.0.0.0	::	0
4	<input type="checkbox"/>	Max: 31 character	0.0.0.0	0.0.0.0	::	0
5	<input type="checkbox"/>	Max: 31 character	0.0.0.0	0.0.0.0	::	0
6	<input type="checkbox"/>	Max: 31 character	0.0.0.0	0.0.0.0	::	0
7	<input type="checkbox"/>	Max: 31 character	0.0.0.0	0.0.0.0	::	0
8	<input type="checkbox"/>	Max: 31 character	0.0.0.0	0.0.0.0	::	0
9	<input type="checkbox"/>	Max: 31 character	0.0.0.0	0.0.0.0	::	0
10	<input type="checkbox"/>	Max: 31 character	0.0.0.0	0.0.0.0	::	0

Authentication

Method

802.1X Method
 Support 802.1X Method
 EAP_TTLS/PAP EAP_TTLS/MSCHAP EAP_TTLS/MSCHAPv2
 EAP_PEAP/MSCHAPv2

User Profile

Available List

Authentication List

Note:
 1. Only the user profiles which is enabled in [User Management >> User Profile](#) will be listed here, and it shows in the [System Maintenance >> Internal Service User List](#).
 2. RADIUS Client Access List is first match.

Available settings are explained as follows:

Item	Description
Enable	Select to enable the router's internal RADIUS server.
Authentication Port	The UDP port for authentication message.
RADIUS Client Access List	Only clients that meet the criteria configured in the access list are allowed to access the RADIUS server. Index - The index number of the client entry. Enable - Select to enable this client entry. Shared Secret - A text string that is known to both the router's RADIUS server and the RADIUS client that is used to authenticate messages sent between them. Maximum length is 36 characters. IP Address - Enter the base address of the IP block.

	<p>IP Mask - Enter the IP mask to configure the size of the IP block.</p> <p>IPv6 Address - Enter the base address of the IPv6 block.</p> <p>IPv6 Length - Enter the prefix length of the IPv6 block.</p>
Authentication	<p>Configures the authentication settings.</p> <p>Specify the way to authenticate the client.</p> <p>PAP - Only the Password Authentication Protocol will be used to validate users.</p> <p>PAP/CHAP/MS-CHAP/MS-CHAPv2 - PAP, CHAP (Challenge-Handshake Authentication Protocol), and Microsoft versions of CHAP can be used to validate users.</p> <p>Support 802.1X Method - The built in RADIUS server offered by Vigor router can act as the AAA server. Select to enable 802.1X support.</p>
User Profile	<p>During the process of security authentication, user account and user password will be required for identity authentication. Before configuring such page, create at least one user profile in User Management>>User Profile first.</p> <p>Select All - Click to move all user profiles under the Available List to the Authentication List.</p> <p>Clear All- Click to remove all user profiles from the Authentication List.</p> <p>Available List - User profiles (created in User Management >> User Profile) that have not been added to the authentication list.</p> <p>Authentication List - User profiles (created in User Management >> User Profile) that have been added to the authentication list. Users can log in using these profiles.</p>

To add a User Profile to the RADIUS server, select it under Available List, then click the >> button. To remove a User Profile from the RADIUS server, select it under Selected Authentication List, then click the << button.

To save changes on the page, click OK. To discard changes, click Cancel. To reset all settings to blank, click Clear.

II-5-5-3 External TACACS+

It means Terminal Access Controller Access-Control System Plus. It works like RADIUS does. Click the External TACACS+ to open the following page:

Applications >> RADIUS/TACACS+

External RADIUS Internal RADIUS External TACACS+

Enable

Primary Server

Server IP Address Max: 15 characters

Destination Port 49

Type ASCII

Shared Secret Max: 36 characters

Confirm Shared Secret Max: 36 characters

Secondary Server

Server IP Address Max: 15 characters

Destination Port 49

Type ASCII

Shared Secret Max: 36 characters

Confirm Shared Secret Max: 36 characters

OK Clear Cancel

Available settings are explained as follows:

Item	Description
Enable	Select to enable the use of an external TACACS+ server.
Primary Server / Secondary Server	Two external TACACS+ servers are allowed to set in this page. The secondary TACACS+ server will be used as a backup server when the primary TACACS+ server is down.
Server IP Address	The IP address of the TACACS+ server.
Destination Port	The port used by the TACACS+ server. Port 49 is most common.
Shared Secret	A text string that is known to both the TACACS+ server and client (the router) that is used to authenticate messages sent between them. Maximum length is 36 characters.
Confirm Shared Secret	Enter the shared secret again for verification.

To save changes on the page, click OK. To discard changes, click Cancel. To reset all settings to blank, click Clear.

II-5-6 Active Directory/ LDAP

Lightweight Directory Access Protocol (LDAP) is an industry-standard protocol for maintaining and accessing directory information on a network. When used in conjunction with a Vigor router, LDAP can be used to authenticate VPN connection attempts.

Active Directory (AD) is a directory service from Microsoft that supports LDAP queries.

To configure Active Directory or LDAP settings, from the Main Menu select **Applications >> Active Directory /LDAP**.

II-5-6-1 General Setup

To configure the settings for the LDAP server, select **General Setup**.

Applications >> Active Directory / LDAP

General Setup | [Set to Factory Default](#) |

<input checked="" type="checkbox"/> Enable	
Bind Type	Anonymous ▾
Server Address	<input type="text"/>
Destination Port	389 <input type="checkbox"/> Use SSL
Regular DN	<input type="text"/>
Regular Password	<input type="password"/>

Active Directory / LDAP Profiles

Index	Name	Distinguished Name
<u>1.</u>		
<u>2.</u>		
<u>3.</u>		
<u>4.</u>		
<u>5.</u>		
<u>6.</u>		
<u>7.</u>		
<u>8.</u>		

Available settings are explained as follows:

Item	Description
Enable	Select to enable LDAP client. If enabled, the LDAP profiles will be available for configuration.
Bind Type	Select from one of 3 bind types: <ul style="list-style-type: none">● Simple Mode - Initiate bind operation (authentication) without performing user search. This mode can be used when all users belong to the same branch in the LDAP structure.● Anonymous - Bind anonymously, without supplying the distinguished name (DN) and password, and perform user

	<p>search. This mode can be used when not all users belong to the same branch and the server allows anonymous searches.</p> <ul style="list-style-type: none"> ● Regular Mode - Same as Anonymous mode, except that the DN and password are sent to the server. This mode can be used when not all users belong to the same branch and the server does not allow anonymous searches. <p>For the regular mode, you'll need to Enter the Regular DN and Regular Password.</p>
Server Address	The network address of the LDAP server.
Destination Port	The network port that the LDAP server listens on. The default ports are 389 for unsecured connections and 636 for LDAPS (LDAP over SSL) connections.
Use SSL	Select to use Secure Sockets Layer (SSL) for LDAP traffic.
Regular DN	Enter the LDAP Distinguished Name for authentication if Bind Type is set to Regular Mode .
Regular Password	Enter the LDAP Password for authentication if Bind Type is set to Regular Mode .
Active Directory / LDAP Profiles	Up to 8 LDAP profiles can be created. These profiles would be used with User Management for different purposes in management.



To save changes on the page, select **OK**; to discard changes, select **Cancel**.

II-5-6-2 Active Directory / LDAP Profiles

To configure an LDAP profile, click on its index to show the following settings page.

Applications >> Active Directory /LDAP>>Server Profiles

Index No. 1

Name	<input type="text" value="RD1"/>
Common Name Identifier	<input type="text" value="UD1"/>
Base Distinguished Name	<input type="text"/> 
Additional Filter	<input type="text"/>
Group Distinguished Name	<input type="text"/> 

Note:

Please type in your additional filter for BaseDN search request. For example, "gidNumber=500" for OpenLDAP, and "msNPAllowDialin=TRUE" for AD.

Available settings are explained as follows:

Item	Description
Name	Name that identifies this profile. Maximum length is 19 characters.
Common Name Identifier	The common name attribute, which is typically "cn" in most LDAP configurations.
Base Distinguished Name	The starting point of user search in the LDAP directory, for example, dc=draytek,dc=com.  - click this icon to display a list of valid DNs in the LDAP

	directory.
Additional Filter	<p>Additional filter to be applied to the search request to identify eligible users.</p> <p>For example,</p> <ul style="list-style-type: none"> - "OpenLDAP: (gidNumber=500)" <p>Here group ID 500 is the group of dial-in users.</p> <ul style="list-style-type: none"> - "ActiveDirectory: (msNPAllowDialin=TRUE)" <p>The msNPAllowDialin attribute indicates that the user has permission to dial in remotely.</p>
Group Distinguished Name	<p>The base DN of the tree in the LDAP directory that contains groups, for example, ou=groups,dc=draytek,dc=com.</p> <p> - click this icon to display a list of valid DNs in the LDAP directory.</p>

To save changes on the page, select **OK**; to discard changes, select **Cancel**.

II-5-7 UPnP

To configure UPnP settings, from the Main Menu select **Applications >> UPnP**.

Applications >> UPnP

UPnP

Enable UPnP Service Default WAN ▾

Enable Connection Control Service

Enable Connection Status Service

Note:

1. To allow NAT pass-through to a UPnP enabled client the connection control service must also be enabled.
2. CAUTION: due to vulnerabilities CVE-2020-12695, UPnP is not considered safe to use. Use it at your own risk.

Available settings are explained as follows:

Item	Description
Enable UPnP Service	Select to enable UPnP.
Default WAN	Select the WAN port on which ports will be opened in response to UPnP commands.
Enable Connection Control Service	Select to enable the connection control service.
Enable Connection Status Service	Select to enable the connection status service.

To save changes on the page, select **OK**; to discard changes, select **Cancel**; to revert all settings to the factory default, select **Clear**.

The reminder as regards concern about Firewall and UPnP:

Can't work with Firewall Software

Enabling firewall applications on your PC may cause the UPnP function not working properly. This is because these applications will block the accessing ability of some network ports.

Security Considerations

Activating UPnP allows any application or network devices to open ports on the WAN side to allow connections to the LAN, which could compromise network security. Also if UPnP applications or network devices malfunction or terminate abnormally, the opened ports may remain open indefinitely, and thus increasing the chance of it getting exploited by malicious parties.

If you do not have applications or network devices which requires UPnP, you are advised to disable UPnP.



Info

UPnP is required for some applications such as PPS, Skype, eMule...and etc. If you are not familiar with UPnP, it is suggested to turn off this function for security.

II-5-8 IGMP

Internet Group Management Protocol (IGMP) is an IPv4 communication protocol for establishing multicast group memberships.

To configure IGMP settings, from the Main Menu select **Applications >> IGMP**.

II-5-8-1 General Setting

Applications >> IGMP

General setting	Working status
<input checked="" type="checkbox"/> IGMP Proxy IGMP Proxy acts as a multicast proxy for hosts on the LAN side. Enable IGMP proxy to access any multicast group. This function takes no effect when Bridge Mode is enabled .	
Interface	WAN1
IGMP version	Auto
General Query Interval	125 (seconds)
Add PPP header (Encapsulate IGMP in PPPoE)	<input type="checkbox"/>
Enable IGMP syslog	<input type="checkbox"/>
<input checked="" type="checkbox"/> IGMP Snooping Enable: Forwards multicast traffic only to ports that are members of that group. Disable: Treats multicast traffic the same as broadcast traffic.	
<input type="checkbox"/> IGMP Fast Leave The router stops forwarding multicast traffic to a LAN port as soon as it receives a leave message from that port. Each LAN port should have no more than one IGMP host connected.	
IGMP Accept List	IP Object None
Only allow the IP of the LAN device to be included in the specified object/group to use IGMP.	
<input type="button" value="OK"/> <input type="button" value="Cancel"/>	

Available settings are explained as follows:

Item	Description
IGMP Proxy	<p>Check this box to enable this function. The application of multicast will be executed through WAN /PVC/VLAN port. In addition, such function is available in NAT mode.</p> <p>Interface - Specify an interface for packets passing through.</p> <p>IGMP version - At present, two versions (v2 and v3) are supported by Vigor router. Choose the correct version based on the IPTV service you subscribe.</p> <p>General Query Interval - Vigor router will periodically check which IP obtaining IPTV service by sending query. It might cause inconvenience for client. Therefore, set a suitable time (unit: second) as the query interval to limit the frequency of query sent by Vigor router.</p> <p>Add PPP header - Check this box if the interface type for IGMP is PPPoE. It depends on the specifications regulated by each ISP. If you have no idea to enable or disable, simply contact your ISP providers.</p> <p>Enable IGMP syslog - Check the box to store the IGMP status ontot Syslog.</p>

IGMP Snooping	Select to enable IGMP Snooping so that multicast traffic are forwarded to IGMP clients that have joined a multicast group.
IGMP Fast Leave	This option is shown only when IGMP Snooping is enabled. Select to enable IGMP Fast Leave. Normally when the router receives a "leave" message from an IGMP host, it will send a last member query message to see if there are still members within the multicast group. When Fast Leave is enabled, multicast for a group is immediately terminated when the last host in that group sends a "leave" message.
IGMP Accept List	Select IP Object or IP Group. Only the IP of the LAN device within the IP object / IP group will be allowed to use IGMP.

To save changes on the page, select **OK**; to discard changes, select **Cancel**.

II-5-8-2 Working Status

Displays a list of active multicast groups.

Applications >> IGMP

General setting		Working status					
Refresh							
Multicast Group Table							
Index	Group ID	P2	P4	P9	P10	P11	P12
IGMP Device Table							
Index	MAC Address	IP Address	Interface	IGMP Version			

Available settings are explained as follows:

Item	Description
Refresh	Click to reload the Multicast Group Table with the latest information.
Index	Index number of the multicast group.
Group ID	ID port of the multicast group, which is within the IP range reserved for IGMP, 224.0.0.0 through 239.255.255.254.
P2 to P12	LAN ports that have IGMP hosts joined to this multicast group.

II-5-9 Wake on LAN

Using the Wake on LAN (WoL) feature, LAN clients that support WoL can be powered on or resume from sleep over the network, without the need for physical access to the device.

In order for LAN clients to be able to wake from sleep or off states, the network interface card must be configured to monitor Wake-on-LAN messages. Consult the documentation of the LAN client for details on setting up its network interface for Wake on LAN.

If you wish to be able to select the IP address of the Wake-on-LAN client, its MAC address must first be bound to a static IP address using the Bind IP to MAC function.

To configure Wake on LAN settings, from the Main Menu select **Applications >> Wake on LAN**.

Applications >> Wake on LAN

Wake on LAN

Wake by:	MAC Address ▾
IP Address:	--- ▾
MAC Address:	FF:FF:FF:FF:FF:FF <input type="button" value="Wake Up!"/>
Result	<div style="border: 1px solid black; height: 20px;"></div>

Note:

Wake on LAN integrates with [Bind IP to MAC](#) function; only bound PCs can wake up through IP.

Available settings are explained as follows:

Item	Description
Wake by	The type of address of the LAN client to be woken up. <ul style="list-style-type: none">● If you choose Wake by MAC Address, you have to Enter the correct MAC address of the host in MAC Address boxes.● If you choose Wake by IP Address, you have to choose the correct IP address.
IP Address	The IP addresses that have been configured in Firewall>>Bind IP to MAC will be shown in this drop down list. Select the IP address of the LAN client.
MAC Address	Enter the MAC address of the LAN client.
Wake Up	Click to send Wake-on-LAN message to the specified LAN client.
Result	Result of the transmission of the Wake-on-LAN message.

II-5-10 SMS / Mail Alert Service

You can set up SMS or mail profiles for the router to send events or alerts to designated recipients. Up to 10 SMS profiles and 10 mail profiles can be configured.

II-5-10-1 SMS Alert

To configure SMS alert profiles, select the SMS Alert tab.

Applications >> SMS / Mail Alert Service

SMS Alert		Mail Alert		Set to Factory Default		
Index	Enable	SMS Provider	Recipient Number	Notify Profile	Schedule(1-15)	
1	<input type="checkbox"/>	1 - ???		1 - ???	None	None
2	<input type="checkbox"/>	1 - ???		1 - ???	None	None
3	<input type="checkbox"/>	1 - ???		1 - ???	None	None
4	<input type="checkbox"/>	1 - ???		1 - ???	None	None
5	<input type="checkbox"/>	1 - ???		1 - ???	None	None
6	<input type="checkbox"/>	1 - ???		1 - ???	None	None
7	<input type="checkbox"/>	1 - ???		1 - ???	None	None
8	<input type="checkbox"/>	1 - ???		1 - ???	None	None
9	<input type="checkbox"/>	1 - ???		1 - ???	None	None
10	<input type="checkbox"/>	1 - ???		1 - ???	None	None

Note:

All the SMS Alert profiles share the same "Sending Interval" setting if they use the same SMS Provider.

OK Cancel

Available settings are explained as follows:

Item	Description
Set to Factory Default	Click to clear all SMS alert profiles.
Enable	Select the checkbox to enable the profile.
SMS Provider	Select the profile of the SMS provider to be used. To set up or modify SMS provider profiles, click the hyperlink SMS Provider to go to Objects Setting >> SMS/Mail Service Object.
Recipient Number	Enter the recipient's SMS number.
Notify Profile	Select the notification profile to be used. To set up or modify notification object profiles, click the hyperlink Notify Profile to go to Objects Setting >> Notification Object.
Schedule (1-15)	Enter up to 2 schedule profile indexes. To set up or modify schedule profiles, click the hyperlink Schedule(1-15) to go to Applications >> Schedule.

After finishing all the settings here, please click **OK** to save the configuration.

II-5-10-2 Mail Alert

To configure mail alert profiles, select the SMS Alert tab.

Application >> SMS / Mail Alert Service

SMS Alert		Mail Alert		Set to Factory Default	
Index	Enable	Mail Service	Mail Address	Notify Profile	Schedule(1-15)
1	<input type="checkbox"/>	1 - ??? ▾		1 - ??? ▾	None ▾ None ▾
2	<input type="checkbox"/>	1 - ??? ▾		1 - ??? ▾	None ▾ None ▾
3	<input type="checkbox"/>	1 - ??? ▾		1 - ??? ▾	None ▾ None ▾
4	<input type="checkbox"/>	1 - ??? ▾		1 - ??? ▾	None ▾ None ▾
5	<input type="checkbox"/>	1 - ??? ▾		1 - ??? ▾	None ▾ None ▾
6	<input type="checkbox"/>	1 - ??? ▾		1 - ??? ▾	None ▾ None ▾
7	<input type="checkbox"/>	1 - ??? ▾		1 - ??? ▾	None ▾ None ▾
8	<input type="checkbox"/>	1 - ??? ▾		1 - ??? ▾	None ▾ None ▾
9	<input type="checkbox"/>	1 - ??? ▾		1 - ??? ▾	None ▾ None ▾
10	<input type="checkbox"/>	1 - ??? ▾		1 - ??? ▾	None ▾ None ▾

Note:

All the Mail Alert profiles share the same "Sending Interval" setting if they use the same Mail Server.

OK Cancel

Available settings are explained as follows:

Item	Description
Set to Factory Default	Click to clear all mail alert profiles.
Enable	Select the checkbox to enable the profile.
Mail Service	Select the profile of the mail provider to be used. To set up or modify a mail provider profile, click the hyperlink Mail Service to go to Objects Setting >> SMS/Mail Service Object.
Mail Address	Enter the recipient's email address.
Notify Profile	Select the notification profile to be used. To set up or modify a notification object profile, click the hyperlink Notify Profile to go to Objects Setting >> Notification Object.
Schedule (1-15)	Enter up to 2 schedule profile indexes. To set up or modify schedule profiles, click the hyperlink Schedule(1-15) to go to Applications >> Schedule.

After finishing all the settings here, please click **OK** to save the configuration.

II-5-11 Bonjour

Bonjour is Apple's implementation of zero-configuration networking (Zeroconf), a technology that allows automatic discovery and configuration of network devices and services. Bonjour is built into OS X, and versions for Windows PCs can be downloaded without charge from Apple's website.

Without Bonjour, routers, computers, and other network peripherals would require manual configuration of network settings such as IP addresses and port numbers, which could be complex and cumbersome. By enabling Bonjour on the Vigor router, users only need to know the name of the router in order to set up connectivity between LAN devices, and the router and the peripherals that are connected to it.

To enable the Bonjour service, click **Application>>Bonjour** to open the following page. Check the box(es) of the server service(s) that you want to share to the LAN clients.

Applications >> Bonjour



Bonjour Setup

<input type="checkbox"/> Enable Bonjour Service
<input type="checkbox"/> HTTP Server
<input type="checkbox"/> Telnet Server
<input type="checkbox"/> SSH Server

OK Cancel

Available settings are explained as follows:

Item	Description
Enable Bonjour Service	Select to enable the Bonjour service on the router. The rest of the checkboxes will be enabled for selection when this checkbox has been selected.
HTTP Server	Select to allow the router's HTTP server to be discovered via Bonjour.
Telnet Server	Select to allow the router's telnet server to be discovered via Bonjour.
SSH Server	Select to allow the router's SSH server to be discovered via Bonjour.

Below shows an example for applying the Bonjour feature that Vigor router can be used as the FTP server.

1. Here, we use Firefox and DNSSD to discover the service in such case. Therefore, just ensure the Bonjour client program and DNSSD for Firefox have been installed on the computer.

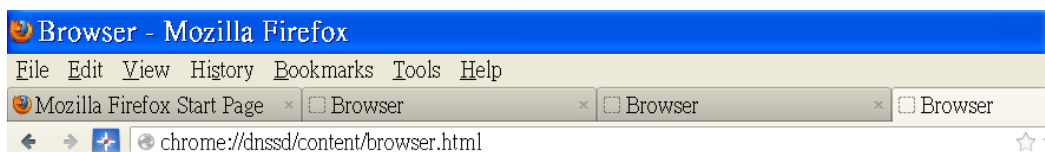

- Open the web browser, Firefox. If Bonjour and DNSSD have been installed, you can open the web page (DNSSD) and see the following results.

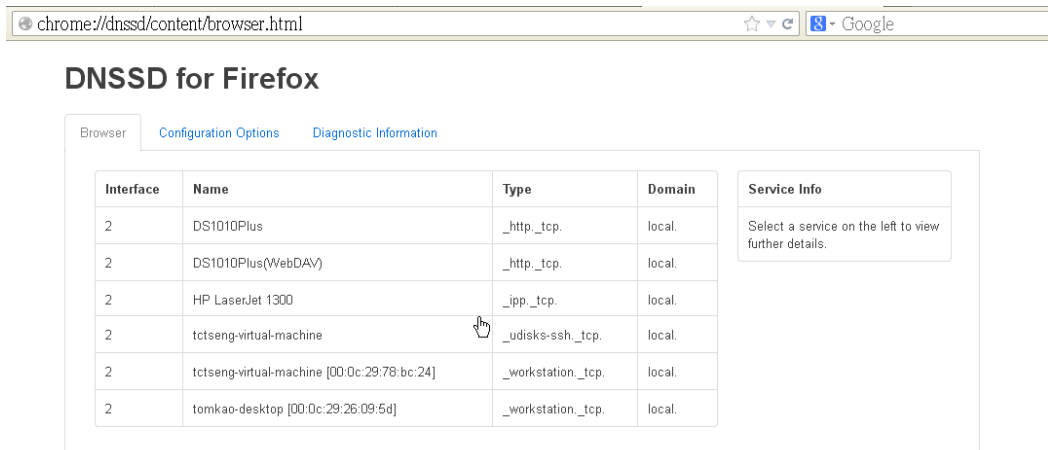

- Open **System Maintenance >> Management**. Type a name (e.g., DrayTek) as the Router Name and click OK.

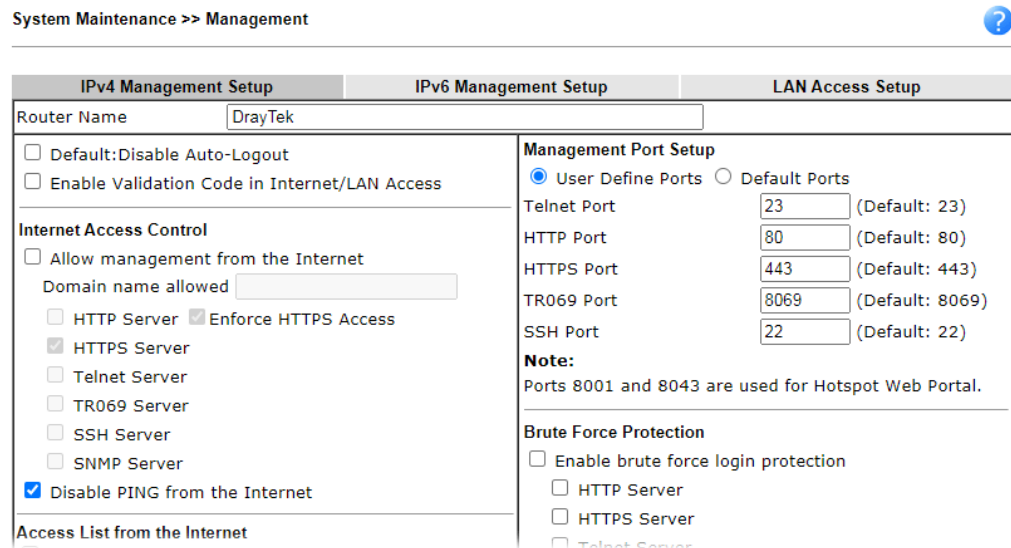

- Next, open **Applications >> Bonjour**. Check the service that you want to use via Bonjour.

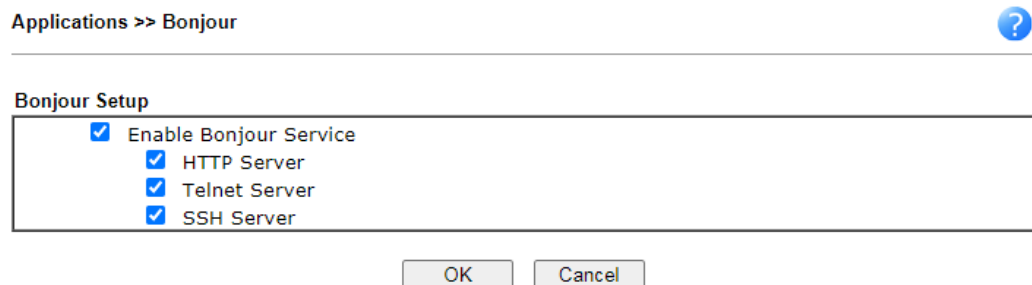

- Open the DNSSD page again. The available items will be changed as the follows. It means the Vigor router (based on Bonjour protocol) is ready to be used as a printer server, FTP server, SSH Server, Telnet Server, and HTTP Server.

DNSSD for Firefox

Browser Configuration Options Diagnostic Information

Interface	Name	Type	Domain	Service Info
2	DS1010Plus	_http._tcp.	local.	Select a service on the left to view further details.
2	DS1010Plus(WebDAV)	_http._tcp.	local.	
2	HP LaserJet 1300	_ipp._tcp.	local.	
2	Vigor Router	_ftp._tcp.	local.	
2	Vigor Router	_http._tcp.	local.	
2	Vigor Router	_printer._tcp.	local.	
2	Vigor Router	_ssh._tcp.	local.	
2	Vigor Router	_telnet._tcp.	local.	
2	tctseng-virtual-machine	_udisks-ssh._tcp.	local.	
2	tctseng-virtual-machine [00:0c:29:78:bc:24]	_workstation._tcp.	local.	
2	tomkao-desktop [00:0c:29:26:09:5d]	_workstation._tcp.	local.	

- Now, any page or document can be printed out through Vigor router (installed with a printer).

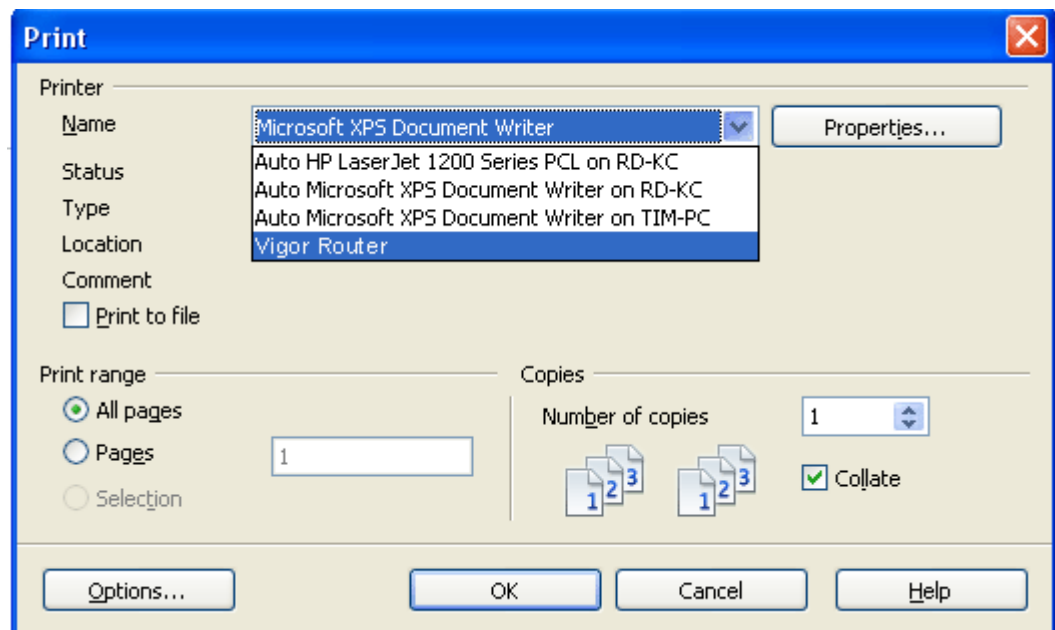

II-5-12 High Availability

The High Availability (HA) feature of the router provides redundancy of network resources, and reduces downtime in case of component failure. The level of sophistication of HA is determined by availability requirements and tolerance of system interruptions. Systems that provide near full-time availability typically have redundant hardware and software.

The HA of the Vigor3912 Series is designed to avoid single points-of-failure. When failures occur, the failover process transfers the network load handled by the failed component (the primary router) to the backup component (the secondary router), and the availability of network resources are preserved and partially failed transactions are recovered. In a matter of seconds the system returns to normal operation.

In order to set up High Availability, at least 2 DrayTek routers have to be configured in the following manner:

- Enable High Availability on both the primary and secondary routers.
- Set a high priority ID on the primary router, and a lower priority ID on the secondary router.
- Configure identical redundancy methods, group IDs, and authentication keys on both routers.
- Set the management interface of both routers to the same subnet.
- Enable virtual IP on both routers for each subnet in use. Make sure the virtual IPs are identical on both routers.

II-5-12-1 General Setup

Open **Applications >> High Availability** to bring up the configuration page to configure High Availability.

Applications >> High Availability



Enable High Availability

Redundancy Method **Active-Standby** ▼

General Setup	Config Sync	Status	Set to Factory Default
Group ID	<input type="text" value="1"/> (1-255)		
Priority ID	<input type="text" value="10"/> (1-30, 30 is highest priority)		
Authentication Key	<input type="text" value="draytek"/>		
Protocol	IPv4 ▼		
Management Interface	LAN1 ▼		
Update DDNS	<input type="checkbox"/> Enable		
Syslog	<input type="checkbox"/> Enable		
IPv4 IPv6			
Index	Enable	Virtual IP	
LAN1	<input type="checkbox"/>	192.168.1.2	
LAN2	<input type="checkbox"/>	192.168.2.2	!
LAN3	<input type="checkbox"/>	192.168.3.2	!
LAN4	<input type="checkbox"/>	192.168.4.2	!
LAN5	<input type="checkbox"/>	192.168.5.2	!
LAN6	<input type="checkbox"/>	192.168.6.2	!
LAN7	<input type="checkbox"/>	192.168.7.2	!

Available settings are explained as follows:

Item	Description
Enable High Availability	Select to enable HA function.
Redundancy Method	<p>Select the redundancy method for high availability.</p> <p>Hot-Standby - Such method is suitable when there is only one ISP account. When this method is selected,</p> <ul style="list-style-type: none"> ● During normal operation the secondary router will be idling. When the primary router fails to operate normally, the secondary router(s) will take over. ● WAN settings of the primary and secondary routers are identical. <p>Note: When Hot-Standby is used, the wireless LAN function on secondary router will be "disabled" directly. Clients can not connect to the secondary router any more.</p> <p>Active-Standby - This method is suitable when there are multiple simultaneously active ISP connections. When this method is selected,</p> <ul style="list-style-type: none"> ● All WANs on the secondary routers can be up at the same time. LANs that are not configured under high availability can be routed to secondary routers. ● WAN settings of primary and secondary routers are independently configured. ● Config Sync may be enabled to synchronize most configuration settings between the primary and secondary routers. ● All routers must be set to the same redundancy method.
Group ID	<p>Enter a value (1-255).</p> <p>All routers having the same group ID belong to the same group.</p>
Priority ID	<p>Enter a value (1-30).</p> <p>Different routers must be configured with different IDs. All routers within a group must be assigned a priority ID. Within a group, the router with the largest priority ID (i.e., the highest priority) will be the primary router. When multiple routers in a group are assigned the same priority ID, routers with lower LAN IP addresses (configured on the LAN >> General Setup page) have higher priority.</p>
Authentication Key	Enter an authentication key up to 31 characters long. This is used to encrypt the DARP (DrayTek Address Redundancy Protocol) traffic to guard against malicious attacks.
Protocol	Select the IP protocol to be used for DARP.
Management Interface	Select the interface to be used for DARP negotiation between routers. Only interfaces which are enabled in LAN>>General Setup are available for selection. However, LAN1 is always enabled.
Update DDNS	Select Enable to update the DDNS server for secondary devices when the primary router fails.

Syslog	Select Enable to have syslog record HA activity.
LAN1 ~ LAN50	Enable - Check the box to enable the interface. Virtual IP - Display the default IP address for each LAN. If required, modify the IP address for the LAN port device.

When you finish the configuration, please click **OK** to save and exit this page.

II-5-12-2 Config Sync

The synchronization of configuration between high availability routers is configured here.

Applications >> High Availability

Enable High Availability

Redundancy Method **Active-Standby** ▼

General Setup	Config Sync	Status	Set to Factory Default
<input type="checkbox"/> Enable Config Sync (Max. Sync to 10 routers)			
Config Sync Interval:			
Day	0 ▼		
Hour	0 ▼		
Minute	15 ▼		
Exclude the following settings from config sync:			
<input checked="" type="checkbox"/> WAN Settings			

Note:

This feature requires that both routers are the same series, and the High Availability must be enabled for Config Sync to operate.

Available settings are explained as follows:

Item	Description
Enable Config Sync (Max. Sync to 10 routers)	Select to enable configuration synchronization. All routers to be synchronized must have this checkbox selected. Note that config sync can be enabled by Hot-Standby redundancy method only.
Config Sync Interval	Day / Hour / Minute - The primary router will synchronize its configuration with secondary routers at every specified time interval.
Exclude the following settings from config sync	This setting is available when the Redundancy Method is set to Hot Standby . Select the configuration settings to be excluded from synchronization.

When you finish the configuration, please click **OK** to save and exit this page.

When the configuration method is set to "Hot Standby", the following settings will not be synchronized:

- WAN (user selectable)

- LAN
- LAN IPv6
- router name
- admin and user passwords.

Example:

Take the following picture as an example. The upper Vigor3912 is regarded as primary device, the lower Vigor3912 is regarded as secondary device. When primary Vigor3912 Series is broken down, the secondary device could replace the primary role to take over all jobs as soon as possible. However, once the primary device is working again, the secondary device would be changed to original role to stand by.

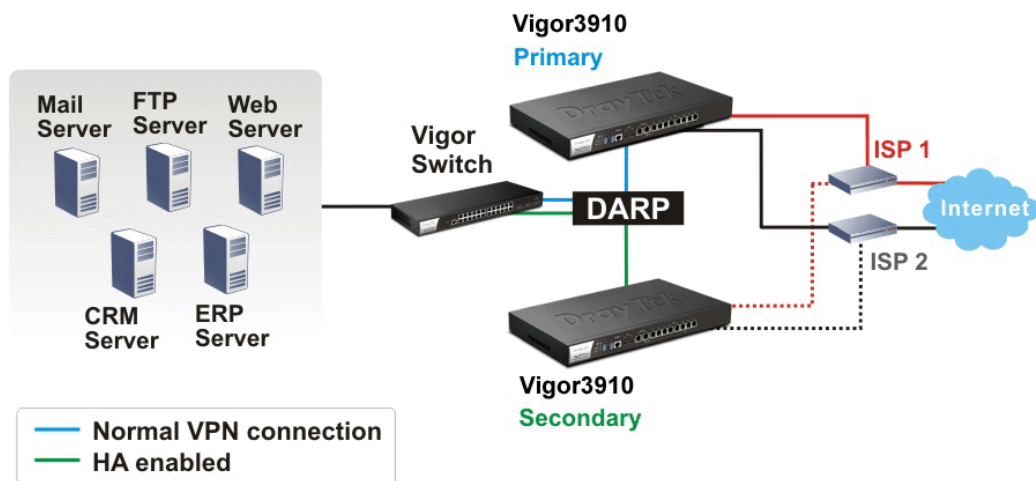

II-5-13 Local 802.1X General Setup

You may configure the built-in 802.1X server here. The local 802.X server can be used to authenticate wired and wireless LAN clients.

Applications >> Local 802.1X General Setup

Local 802.1X General Setup

Enable

EAP_TTLS/PAP EAP_TTLS/MSCHAP EAP_TTLS/MSCHAPv2
 EAP_PEAP/MSCHAPv2

User Profile

Available List	Authentication List

Sync User Profile Setting to Internal RADIUS

Note:

1. Only the user profiles which is enabled in **User Management >> User Profile** will be listed here.
2. **Wired 802.1X** used the same **User Profile** as its identity and password.

Available settings are explained as follows:

Item	Description		
Enable	Select it to enable the built-in 802.1X server. At present, such feature can be used for wireless and wired 802.1x authentication.		
User Profile	Select All - Click to add all User Profiles to the 802.1X server. All profiles will appear under the Authentication List. Clear All - Remove all user profiles from the 802.1X server. All profiles will appear under Available List.		
Sync User Profile	Make the enabling/disabling setting for both Internal RADIUS and Local 802.1X synchronize for all of the user profiles (User Management>>User Profile). For example, if Local 802.1x is configured as Enabled (checked), the Internal RADIUS will be configured as Enabled too. <div style="border: 1px solid black; padding: 5px;"> <p>3. Internal Services</p> <table border="1" style="width: 100%;"> <tr> <td><input checked="" type="checkbox"/> Internal RADIUS</td> <td><input checked="" type="checkbox"/> Local 802.1X</td> </tr> </table> <p>Note: Internal Services means the account and password of this user profile can be used by other application.</p> <p style="text-align: center;"><input type="button" value="OK"/> <input type="button" value="Refresh"/> <input type="button" value="Clear"/> <input type="button" value="Cancel"/></p> </div> If Local 802.1X is configured as Disabled (unchecked), the	<input checked="" type="checkbox"/> Internal RADIUS	<input checked="" type="checkbox"/> Local 802.1X
<input checked="" type="checkbox"/> Internal RADIUS	<input checked="" type="checkbox"/> Local 802.1X		

	<p>Internal RADIUS will be changed as Disabled too, even if it is enabled previously.</p> 
OK	Click it to save the settings.
Cancel	Click it to give up all settings configuration.

When you finish the configuration, please click **OK** to save and exit this page.

II-5-14 Smart Action

Smart Action allows you to run some tasks (e.g., sending alerts, mails, or removing a VPN profile) automatically at a specified date, a cycle time, or a specified situation. Vigor user can pre-configure up to 64 profiles to manage different tasks.

Applications >> Smart Action

Smart Action Setup							Set to Factory Default
Index	Enable	Comment	Event Group	Event type	Action Group	Action type	
1.	<input type="checkbox"/>						
2.	<input type="checkbox"/>						
3.	<input type="checkbox"/>						
4.	<input type="checkbox"/>						
5.	<input type="checkbox"/>						
6.	<input type="checkbox"/>						
7.	<input type="checkbox"/>						
8.	<input type="checkbox"/>						
9.	<input type="checkbox"/>						
10.	<input type="checkbox"/>						

[<<](#) | [1-10](#) | [11-20](#) | [21-30](#) | [31-40](#) | [41-50](#) | [51-60](#) | [61-64](#) >>
 [Next](#) >>

OK

To configure a profile, click on its index to show the following settings page.

Applications >> Smart Action

Profile Index : 1

Enable

Comment:

Event Category:

Event Type:

Schedule Profile:

Action Category:

Action Type:

Note:

1. Comment can not contain characters ~ ! @ # \$ % ^ & * () ' " { } | ;
2. If use CLI, user can put two or more commands on the same line separated by the semicolon
3. If use Webhook POST Content, only JSON format be accepted

Available settings are explained as follows:

Item	Description
Enable	Select to enable this function.
Comment	Describe the name/focus of this profile.
Event Category	Select an event (e.g., System).

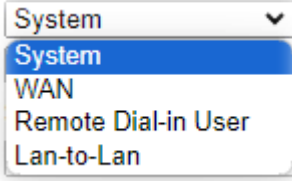
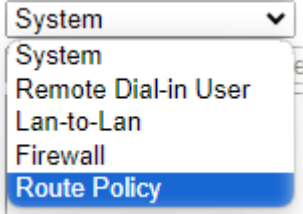
	
Event Type	<p>Select an event type.</p> <p>Schedule - Specify a schedule profile to perform the job based on conditions determined by the action category and action type.</p> <ul style="list-style-type: none"> ● Schedule Profile - Use the drop-down list to select a profile. If there is no schedule defined previously, click [Create New] to set a new schedule. <p>Date and Time - Set the year, month, day, hour and minute to perform the job.</p> <p>CPU Usage - When the usage of the CPU reaches the threshold, a job based on the conditions set below will be performed.</p> <ul style="list-style-type: none"> ● Usage threshold - Select a value. <p>Memory Usage - When the usage of the memory reaches the threshold, a job based on the conditions set below will be performed.</p> <ul style="list-style-type: none"> ● Usage threshold - Select a value. <p>Session Usage - When the session limit reaches the threshold, a job based on the conditions set below will be performed.</p> <ul style="list-style-type: none"> ● Usage - Enter a value as a threshold.
Action Category	<p>Select an action category to set the corresponding action type.</p>  <ul style="list-style-type: none"> ● System ● Remote Dial-in User ● Lan-to-Lan ● Firewall ● Route Policy
Action Type	<p>Available actions vary based on the selected action category.</p> <p>To perform a CLI or send out an e-mail, select System as the Action Category.</p> <ul style="list-style-type: none"> ● Command Line Interface - Put two or more commands on the same line separated by a semicolon. ● Mail Alert - Send an alert mail to a recipient. <ul style="list-style-type: none"> - Email Notification Object - Select a mail service object . - Recipient - Enter the e-mail address of the recipient.

	<ul style="list-style-type: none"> - Subject - Enter the title of the e-mail. - Message - Enter the content of the message for sending to the recipient. ● Webhook - When the above event (meeting event category and event type) is triggered, Vigor system will construct an HTTPS POST with JSON content and transmit the detail to the specified server URL. <ul style="list-style-type: none"> - Server URL - Enter the URL of the webhook server. - POST Content - Enter the content in JSON format. <p>To enable, disable or terminate the VPN connection by the remote dial-in user, select Remote Dial-in User as the Action Category.</p> <ul style="list-style-type: none"> ● Enable Profile - Enable the remote dial-in user profile. ● Disable Profile - Disable the selected remote dial-in user profile. ● Drop Connection - Terminate VPN connection for the selected remote dial-in user profile. <p>To enable, disable or terminate the VPN connection by the LAN to LAN profile, select Lan-to-Lan as the Action Category,</p> <ul style="list-style-type: none"> ● Enable Profile - Enable the LAN to LAN profile. ● Disable Profile - Disable the selected LAN to LAN profile. ● Drop Connection - Terminate VPN connection for the selected LAN to LAN profile. <p>To filter the packets via the firewall rule, select Firewall as the Action Category,</p> <ul style="list-style-type: none"> ● Data Filter:Start Filter Set - Select one of the filter rules as the base for Vigor router processing the event. ● Enable Rule - Select two sets of the rule profiles. ● Disable Rule - Select two sets if the rule profiles. <p>To deliver the packets based on the route policy, select Route Policy as the Action Category,</p> <ul style="list-style-type: none"> ● Enable Rule - Select two sets of the rule profiles. ● Disable Rule - Select two sets if the rule profiles.
--	--

When you finish the configuration, please click **OK** to save and exit this page.

Application Notes

A-1 How to use DrayDDNS?

Vigor router supports various DDNS service providers, user can set up user-defined profile to update the DDNS even the service provider is not on the list. Now, DrayTek starts to support our own DDNS service - DrayDDNS. We will provide a domain name for each Vigor router, this single domain name can record IP addresses of all WAN.

Set up DrayDDNS on DrayOS Router

1. Go to **Applications >> Dynamic DNS**. Enable Dynamic DNS Setup.

Applications >> Dynamic DNS Setup

Dynamic DNS Setup | [Set to Factory Default](#) |

Enable Dynamic DNS Setup

Auto-Update interval Min(s) (180~14400)

Accounts:

Index	Enable	WAN Interface	Domain Name
<u>1.</u>	<input checked="" type="checkbox"/>	WAN 3/5	garytest.drayddns.com
<u>2.</u>	<input type="checkbox"/>	WAN1 First	
<u>3.</u>	<input type="checkbox"/>	WAN1 First	
<u>4.</u>	<input type="checkbox"/>	WAN1 First	
<u>5.</u>	<input type="checkbox"/>	WAN1 First	
<u>6.</u>	<input type="checkbox"/>	WAN1 First	

2. Go to **Wizards >> Service Activation Wizard** page, wait for the router to connect to MyVigor server, then:
 - (a) Select **DT-DDNS**.
 - (b) Enter the desired Domain Name.
 - (c) Make sure you have read the License Agreement. Check **I have read and accept the above Agreement**, then click **Next**.

Service Activation Wizard

Select the service type that you want to activate

Activation Date : 2024-01-11

Web Content Filter(WCF) Service :

BPjM [License Agreement](#)
This is a web content filter that is provided by the German government. It is a free service without any guarantee and will expire one year after activation. You may re-activate the service after expiry.

URL Reputation 30-Day Free Trial [License Agreement](#)
To activate the 30-day trial license, you will need a MyVigor account and register the router to the MyVigor account first. [How To... Upgrade Firmware to v4.4.3 or later is mandatory. More Details...](#)

APP Enforcement(APPE) Service :

DT-APPE [License Agreement](#)
Upgrade APPE Signature automatically.

Dynamic DNS(DDNS) Service :

DT-DDNS [License Agreement](#)
This Dynamic Domain Name service is provided by DrayTek Corporation. To activate the DrayDDNS (Global) service, please select this option to activate the license. This is a 1-year free license key. For re-activation after expiry, you have to obtain a new license from MyVigor website (<https://myvigor.draytek.com>).

I agree to let the MyVigor server record the WAN or Internet IP address of this router in order to activate the DrayDDNS service.
You can stop this service and clear your IP address at any time.

Domain Name : .drayddns.com

I have read and accept the above Agreement. (Please check this box).

Next > Cancel

3. Confirm the information, then click **Activate**.

Service Activation Wizard

Please confirm your settings

Service Type : Trial version
Service Activated : Dynamic DNS (demo.drayddns.com)

Please click **Back** to re-select service type you to activate.

< Back Activate Cancel

4. MyVigor server will reply with the service activation information.

DrayTek Service Activation

Service Name	Start Date	Expire Date	Status
Web Content filter	---	---	Not Activated
APP Enforcement	---	---	Not Activated
DDNS	2018-01-18	2019-01-18	DT-DDNS

Please check if the license fits with the service provider of your signature. To ensure normal operation for your router, update your signature again is recommended.

Copyright © DrayTek Corp. All Rights Reserved.

- Vigor router will contact with MyVigor server, then get the DrayDDNS license as well as the domain name back, and create the DDNS profile automatically. Please go to **Applications >> Dynamic DNS Setup** page to make sure the router has created the DDNS profile.

Applications >> Dynamic DNS Setup

Set to Factory Default

Enable Dynamic DNS Setup

Auto-Update interval Min(s) (180~14400)

Accounts:

Index	WAN Interface	Domain Name	Active
1.	WAN 1/2/3/4	demo.drayddns.com	v
2.	WAN1 First		x
3.	WAN1 First		x
4.	WAN1 First		x
5.	WAN1 First		x
6.	WAN1 First		x

Note that, if your router does not get the domain after you activating the license, it may due to the router does not trigger the process, which to connect and get the license from MyVigor server. You may reboot the router to trigger the process.

Modify DrayDDNS Domain Name

Currently, only the domain name is allowed to be modified MyVigor website. We will need to register the router to MyVigor server, and log in to MyVigor website to modify it.

- Please visit <https://myvigor.draytek.com/> or go to **Applications >> Dynamic DNS Setup >> DrayDDNS** profile and click **Edit domain**.

Applications >> Dynamic DNS Setup >> Dynamic DNS Account Setup

Index : 1

Enable Dynamic DNS Account
Service Provider: DrayDDNS (Global)
Status: **Activated** [Start Date:2018-01-19 Expire Date:2019-01-19]
Domain Name: demo . drayddns.com Edit domain
Determine WAN IP: WAN IP IPv4 IPv6
WAN Interfaces: WAN 1 WAN 2 WAN 3 WAN 4

OK Clear Cancel

2. Log in to MyVigor Website, choose the profile, then click Edit DDNS settings.

My Information - My Products

Device Information

Device Name : FAE2860
Serial Number : 2016-0205
Model : Vigor2860 Series

Rename Transfer Back

Device's Service Expired License

Service	Provider	Action	Status	Start Date	Expired Date	Note
WCF	BPjM	Activate	● On	-	-	-
WCF	Cyren	Trial	● On	-	-	-
APPE	DT-APPE	Activate	● On	-	-	-
DDNS	DT-DDNS	Renew	● On	2018-01-19	2019-01-19	Edit DDNS settings

3. Input the desired Domain name and click Update.

Edit DDNS Settings

Domain Name: modification . drayddns.com

Current IP: 192.168.100.100 Get PC's Internet IP

Last Update: 2018-01-22 14:26:29

Status: **Update success**

Update Delete Reset

4. Vigor router will get the modified domain name when the it performs next DDNS updating. We can click Sync domain to accelerate this process.

Applications >> Dynamic DNS Setup >> Dynamic DNS Account Setup

Index : 1

Enable Dynamic DNS Account

Service Provider: DrayDDNS (Global)

Status: **Activated** [Start Date:2018-01-19 Expire Date:2019-01-19]

Domain Name: demo.drayddns.com Sync domain

Determine WAN IP: WAN IP IPv4 IPv6

WAN Interfaces: WAN 1 WAN 2 WAN 3 WAN 4

OK Clear Cancel

5. After few seconds, the router will get the new domain name and print it on the profiles list.

Applications >> Dynamic DNS Setup

Dynamic DNS Setup | [Set to Factory Default](#)

Enable Dynamic DNS Setup View Log Force Update

Auto-Update interval: 14400 Min(s) (180~14400)

Accounts:

Index	WAN Interface	Domain Name	Active
1.	WAN 1/2/3/4	demo.drayddns.com	v
2.	WAN1 First		x
3.	WAN1 First		x
4.	WAN1 First		x
5.	WAN1 First		x
6.	WAN1 First		x

↓

1.	WAN 1/2/3/4	modification.drayddns.com	v
----	-------------	---------------------------	---

II-6 Routing

Route Policy (also well known as PBR, policy-based routing) is a feature where you may need to get a strategy for routing. The packets will be directed to the specified interface if they match one of the policies. You can setup route policies in various reasons such as load balance, security, routing decision, and etc.

Through protocol, IP address, port number and interface configuration, Route Policy can be used to configure any routing rules to fit actual request. In general, Route Policy can easily reach the following purposes:

Load Balance

You may manually create policies to balance the traffic across network interface.

Specify Interface

Through dedicated interface (WAN/LAN/VPN), the data can be sent from the source IP to the destination IP.

Address Mapping

Allows you specify the outgoing WAN IP address (es) for an internal private IP address or a range of internal private IP addresses.

Priority

The router will determine which policy will be adopted for transmitting the packet according to the priority of Static Route and Route Policy.

Failover to/Failback

Packets will be sent through another Interface or follow another Policy when the original interface goes down (**Failover to**). Once the original interface resumes service (**Failback**), the packets will be returned to it immediately.

Other routing

Specify routing policy to determine the direction of the data transmission.



Info

For more detailed information about using policy route, refer to [Support >> Tech Support >>FAQs](#) on www.draytek.com.

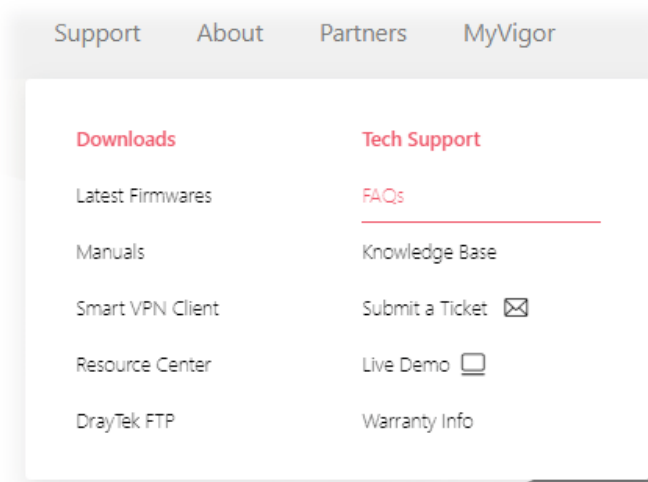

Web User Interface

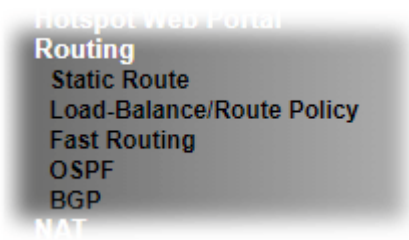

II-6-1 Static Route

Go to **Routing >> Static Route**. You can create static routes so that traffic to specific IP addresses go through a particular LAN or WAN.

The Static Route Setup screen has separate tabs for IPv4 and IPv6. Select the appropriate tab to begin.

II-6-1-1 Static Route for IPv4

Routing >> Static Route

IPv4		IPv6	Set to Factory Default	View Routing Table	
Index	Enable	Destination Address	Mask	Gateway	Interface
1.	<input type="checkbox"/>				
2.	<input type="checkbox"/>				
3.	<input type="checkbox"/>				
4.	<input type="checkbox"/>				
5.	<input type="checkbox"/>				
6.	<input type="checkbox"/>				
7.	<input type="checkbox"/>				
8.	<input type="checkbox"/>				
9.	<input type="checkbox"/>				
10.	<input type="checkbox"/>				
11.	<input type="checkbox"/>				
12.	<input type="checkbox"/>				
13.	<input type="checkbox"/>				
14.	<input type="checkbox"/>				

Available settings are explained as follows:

Item	Description
Set to Factory Default	Clear all of the settings and return to factory default settings.

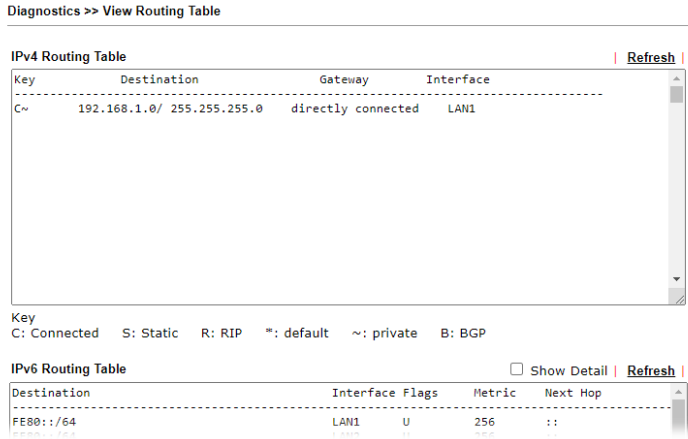
Viewing Routing Table	<p>Displays the routing table for your reference.</p> 
Index	<p>The number (1 to 300) under Index allows you to open next page to set up static route.</p>
Enable	<p>Enables or disables the static route.</p>
Destination Address	<p>Beginning destination address.</p>
Mask	<p>Subnet mask of the destination address.</p>
Gateway	<p>IP address of the gateway, which is the host that the traffic needs to go through to reach the destination.</p>
Interface	<p>The LAN or WAN that should be used to contact the gateway.</p>
Backup	<p>Click it to backup the configuration of static route settings.</p>
Restore	<p>Click it to restore the configuration of static route settings. Before clicking, make sure upload the configuration file onto Vigor router.</p>

Add Static Routes to Private and Public Networks

Here is an example (based on IPv4) of setting Static Route in Main Router so that user A and B locating in different subnet can talk to each other via the router. Assuming the Internet access has been configured and the router works properly:

- use the Main Router to surf the Internet.
- create a private subnet 192.168.10.0 using an internal Router A (192.168.1.2)
- create a public subnet 211.100.88.0 via an internal Router B (192.168.1.3).
- have set Main Router 192.168.1.1 as the default gateway for the Router A 192.168.1.2.

Before setting Static Route, user A cannot talk to user B for Router A can only forward recognized packets to its default gateway Main Router.

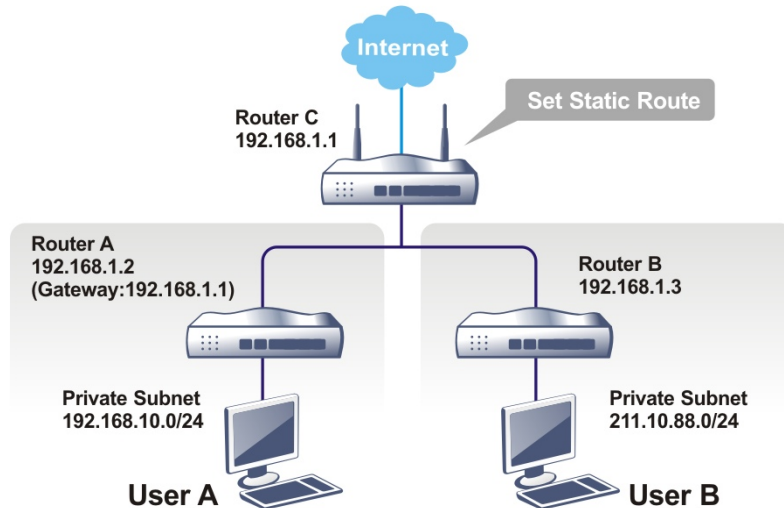

1. Go to **Routing** page and click **General Setup**, select 1st Subnet as the **RIP Protocol Control**. Then click the **OK** button.



Info

There are two reasons that we have to apply RIP Protocol Control on 1st Subnet. The first is that the LAN interface can exchange RIP packets with the neighboring routers via the 1st subnet (192.168.1.0/24). The second is that those hosts on the internal private subnets (ex. 192.168.10.0/24) can access the Internet via the router, and continuously exchange of IP routing information with different subnets.

2. Click the **Routing >> Static Route** and click on the **Index Number 1**. Check the **Enable** box. Please add a static route as shown below, which regulates all packets destined to 192.168.10.0 will be forwarded to 192.168.1.2. Click **OK**.

Routing >> Static Route

Index No. 1

<input type="checkbox"/> Enable	
Destination IP Address	???
Subnet Mask	255.255.255.0 / 24
Gateway IP Address	
Network Interface	LAN1

Available settings are explained as follows:

Item	Description
Enable	Enables or disables the static route.
Destination IP Address	Beginning destination address. Enter an IP address as the destination of the static route.
Subnet Mask	Subnet mask of the destination address. Enter the subnet mask for the static route.
Gateway IP Address	Enter the IP address of the gateway, which is the host that the traffic needs to go through to reach the destination.

Network Interface	Use the drop down list to specify an interface for such static route. The LAN or WAN that should be used to contact the gateway.
--------------------------	--

- Return to **Static Route Setup** page. Click on another **Index Number** to add another static route as show below, which regulates all packets destined to 211.100.88.0 will be forwarded to 192.168.1.3. Click OK.

Routing >> Static Route Setup

Index No. 2

Enable

Destination IP Address:

Subnet Mask:

Gateway IP Address:

Network Interface:

Note:

WAN7, WAN8, WAN9 are PVCs or VLANs that can be configured on the [Multi-PVC/VLAN](#) page.

- Go to **Diagnostics** and choose **Routing Table** to verify current routing table.

Diagnostics >> View Routing Table

IPv4 Routing Table | [Refresh](#)

Key	Destination	Gateway	Interface
S~	192.168.10.0/ 255.255.255.255	via 192.168.1.2	LAN1
C~	192.168.1.0/ 255.255.255.0	directly connected	LAN1
S~	211.100.88.0/ 255.255.255.255	via 192.168.1.3	LAN1

II-6-1-2 Static Route for IPv6

You can set up to 300 profiles for IPv6 static route. Click on a route index on the IPv6 tab to configure an IPv6 static route.

Routing >> Static Route Setup

IPv4		IPv6	Set to Factory Default View IPv6 Routing Table	
Index	Enable	Destination Address	Gateway	Interface
1.	<input type="checkbox"/>			
2.	<input type="checkbox"/>			
3.	<input type="checkbox"/>			
4.	<input type="checkbox"/>			
5.	<input type="checkbox"/>			
6.	<input type="checkbox"/>			
7.	<input type="checkbox"/>			

Available settings are explained as follows:

Item	Description
Set to Factory Default	Clear all of the settings and return to factory default settings.
Viewing IPv6 Routing Table	Displays the routing table for your reference.

Index	The number (1 to 300) under Index allows you to open next page to set up static route.
Enable	Enables or disables the static route.
Destination Address	Beginning destination address.

Click any underline of index number to get the following page.

[Routing >> Static Route Setup](#)

Index No. 1

Enable
Destination IPv6 Address / Prefix Len /
Gateway IPv6 Address
Network Interface

Available settings are explained as follows:

Item	Description
Enable	Enables or disables the static route.
Destination IPv6 Address / Prefix Len	Beginning destination address and the number of bits in the subnet mask of the destination IPv6 address. Enter the IP address with the prefix length for this entry.
Gateway IPv6 Address	IP address of the gateway, which is the host that the traffic needs to go through to reach the destination.
Network Interface	The LAN or WAN that should be used to contact the gateway.

When you finish the configuration, please click **OK** to save and exit this page.

II-6-2 Load-Balance/Route Policy

The Load-Balance/Route Policy feature gives you control over how different types of outbound traffic are routed, through any of the LANs, WANs or VPNs. The policy set in Load-Balance/Route Policy always has higher priority than **Default Route** and **Auto Load Balance** set in WAN >> **Internet Access**, and always has lower priority than the **Firewall Rules**. Administrator may also define a priority to this policy.

II-6-2-1 General Setup

To add, delete or modify load balance or route policies, select **Routing >> Load-Balance / Route Policy** from the menu bar.

Routing >> Load-Balance/Route Policy ?

Load-Balance/Route Policy 10 rules per page | [Set to Factory Default](#) | [Diagnose](#) |

Index	Enable	Comment	Protocol	Interface	Priority	Source	Destination	Dest Port	Move Up	Move Down
1	<input type="checkbox"/>		Any	WAN1	200	Any	Any	Any		Down
2	<input type="checkbox"/>		Any	WAN1	200	Any	Any	Any	UP	Down
3	<input type="checkbox"/>		Any	WAN1	200	Any	Any	Any	UP	Down
4	<input type="checkbox"/>		Any	WAN1	200	Any	Any	Any	UP	Down
5	<input type="checkbox"/>		Any	WAN1	200	Any	Any	Any	UP	Down
6	<input type="checkbox"/>		Any	WAN1	200	Any	Any	Any	UP	Down
7	<input type="checkbox"/>		Any	WAN1	200	Any	Any	Any	UP	Down
8	<input type="checkbox"/>		Any	WAN1	200	Any	Any	Any	UP	Down
9	<input type="checkbox"/>		Any	WAN1	200	Any	Any	Any	UP	Down
10	<input type="checkbox"/>		Any	WAN1	200	Any	Any	Any	UP	Down

<< [1-10](#) | [11-20](#) | [21-30](#) | [31-40](#) | [41-50](#) | [51-60](#) | [61-70](#) | [71-80](#) | [81-90](#) | [91-100](#) | [101-110](#) | [111-120](#) | [121-130](#) | [131-140](#) | [141-150](#) | [151-160](#) | [161-170](#) | [171-180](#) | [181-190](#) | [191-200](#) | [201-210](#) | [211-220](#) | [221-230](#) | [231-240](#) | [241-250](#) >>

Wizard Mode: most frequently used settings in three pages
 Advance Mode: all settings in one page

Note:
The policies in blue are SD-WAN related, and can only be edited via ACS.

Available settings are explained as follows:

Item	Description
Rules per page	The number of rules to display on a single page.
Set to Factory Default	Clear the settings of all Load-Balance and Route Policy rules.
Index	Rule index. Click to bring up the configuration page of the rule.
Enable	Select to enable this rule.
Protocol	Protocol(s) to which this rule applies.
Interface	LAN, IP Routed Subnet, WAN or VPN interface that the traffic described by this rule is to be directed.
Priority	The priority of this rule.
Source	The beginning and ending source IP addresses.
Destination	The beginning and ending destination IP addresses.
Dest Port	The beginning and ending destination port number.
Move UP/Move Down	Click to shift priority of rule up/down by one.
Wizard Mode	The setup wizard will present the most-commonly used rule settings in three steps.

Advance Mode	All the rule settings will be shown on one configuration page.
---------------------	--

If Wizard Mode is selected, you will be guided through the configuration process in three steps. Only the most commonly used settings will be shown.

1. Click the **Wizard Mode** radio button.
2. Click **Index 1**. The setting page will appear as follows:

Routing >> Load-Balance/Route Policy

Index: 1 Criteria

Load-Balance/Route Policy applies to packets that meet the following criteria

Source IP

Any

Src IP Start Src IP End

[] ~ []

Destination IP

Any

Dest IP Start Dest IP End

[] ~ []

Country Object

Available settings are explained as follows:

Item	Description
Source IP	Source IP addresses to which this rule is to be applied. Any - This rule applies to all source IP addresses. Src IP Start, Src IP End - This rule applies to the specified range of source IP addresses. If there is only one source IP address, enter the address in both the Start and End fields.
Destination IP	Destination IP addresses to which this rule is to be applied. Any - This rule applies to all destination IP addresses. Dest IP Start, Dest IP End - This rule applies to the specified range of destination IP addresses. If there is only one destination IP address, enter the address in both the Start and End fields. Country Object - Specify a country object. All the IPs coming from the country (countries) specified in the object will be passed through the WAN interface.

3. Click **Next** to get the following page.

Routing >> Load-Balance/Route Policy

Index: 1 Interface

Load-Balance/Route Policy directs the packets to the interface below

Interface

WAN1

LAN3
 LAN4
 LAN5
 LAN6
 LAN7
 LAN8
 LAN9

Available settings are explained as follows:

Item	Description
Interface	You can select an interface from one of the following: WAN, LAN, VPN, and IP Routed Subnet. Packets match with the above criteria will be transferred to the interface chosen here. Select an interface from the list.

- Specify an interface and click **Next**. The following page will appear only if you choose WAN1 ~WAN7 as Interface.

Routing >> Load-Balance/Route Policy

Index: 1 NAT or Routing

Based on the settings in the previous pages, we guess you want to have: Force NAT

The current setting is:

Force NAT
 Force Routing

Available settings are explained as follows:

Item	Description
Force NAT /Force Routing	It determines which mechanism that the router will use to forward the packet to WAN.

- After choosing the mechanism, click **Next** to get the summary page for reference.

Load-Balance/Route Policy

Index: 1 Configuration Summary

Criteria

Source IP Any
Destination IP 192.168.1.6 ~ 192.168.1.56

Interface

WAN3

More options

Force NAT

- If there is no error, click **Finish** to complete wizard setting. To make changes, click **Back** to return to the previous pages. To discard all changes, click **Cancel**.

If **Advance Mode** is selected, you will be presented with a single page with all the configurable settings for the rule.

- Click the **Advance Mode** radio button.
- Click **Index 1** to access into the following page.

Index: 1

Enable

Comment

Criteria

Protocol
 Source
 Destination
 Destination Port

Send via if Criteria Matched

Interface

Interface Mode

Gateway

Default Gateway
 Specific Gateway

Packet Forwarding to WAN/LAN via

Force NAT
 Force Routing

Failover to

WAN/LAN
 VPN
 Route Policy
 Gateway Default Gateway
 Specific Gateway

Priority

New sessions affected by this Policy will be sent via primary interface once that interface resumes service; while existing sessions will remain on the failovered interface.

Note:

Force NAT(Routing): NAT(Routing) will be performed on outgoing packets, regardless of which type of subnet (NAT or IP Routing) they originate from.

Available settings are explained as follows:

Item	Description
Enable	Select to enable rule and unlock all fields for configuration.
Comment	Type a brief explanation for such profile.
Criteria	<p>Router examines outgoing LAN traffic to find the first rule whose criteria are satisfied.</p> <p>Protocol - Use the drop-down menu to choose a proper protocol for the WAN interface.</p> <p>Source - Source IP addresses to which this rule is to be applied.</p> <ul style="list-style-type: none"> ● Any - This rule applies to all source IP addresses. ● IP Range - This rule applies to the specified range of source IP addresses. <ul style="list-style-type: none"> - Start - Enter an address as the starting IP for such profile. - End - Enter an address as the ending IP for such profile. ● IP Subnet - This rule applies to source IP addresses defined by the specified network IP address and subnet mask. <ul style="list-style-type: none"> - Network - Enter an IP address here. - Mask - Use the drop down list to choose a suitable

	<p>mask for the network.</p> <ul style="list-style-type: none"> ● IP Object / IP Group - Use the drop down list to choose a preconfigured IP object/group. <p>Destination - Destination IP addresses to which this rule is to be applied.</p> <ul style="list-style-type: none"> ● Any - This rule applies to all source IP addresses. ● IP Range -This rule applies to the specified range of destination IP addresses. <ul style="list-style-type: none"> - Start - Enter an address as the starting IP for such profile. - End - Enter an address as the ending IP for such profile. ● IP Subnet - This rule applies to destination IP addresses defined by the specified network IP address and subnet mask. <ul style="list-style-type: none"> - Network - Enter an IP address here. - Mask - Use the drop down list to choose a suitable mask for the network. ● Domain Name - Specify a domain name as the destination. <ul style="list-style-type: none"> - Select - Click it to choose an existing domain name defined in Objects Setting>>String Object. - Delete - Remove current used domain name. - Add - Create a new domain name as the destination. ● IP Object / IP Group - Use the drop down list to choose a preconfigured IP object/group. ● Country Object - Use the drop down list to choose a preconfigured object. Then all IPs within that country will be treated as the destination IP. <p>Destination Port - Destination port numbers to which this rule is to be applied. As only TCP and UDP protocols use port numbers, this setting does not apply to the ICMP protocol.</p> <ul style="list-style-type: none"> ● Any - This rule applies to all destination ports. ● Dest Port Range - This rule applies to the specified range of destination ports. <ul style="list-style-type: none"> - Start - Enter the destination port start for the destination IP. - End - Enter the destination port end for the destination IP. If this field is blank, it means that all the destination ports will be passed through the WAN interface.
<p>Send via if Criteria Matched</p>	<p>If criteria are matched, the traffic will be sent to the designated interface and gateway.</p> <p>Interface - Packets match with the above criteria will be transferred to the interface chosen here. Select an interface from the list (WAN/LAN: A WAN or LAN interface; VPN: A Virtual Private Network).</p> <p>Interface Mode - It is available if WAN is selected as the Interface.</p> <ul style="list-style-type: none"> ● IP Based Load Balance - The same source / destination IP pair will select the same WAN interface as policy. It is the default setting. ● Session Based Load Balance - All of the WAN interfaces

	<p>will be used (as out-going WAN) for passing through new sessions to get better transmission speed. Though good speed test result for throughput might be reached; however, some web site may not open smoothly, especially the site need authentication, e.g., FTP.</p> <p>If you have no strong demand about speed test result, keep default settings as IP based.</p> <p>Gateway - Select a gateway.</p> <ul style="list-style-type: none"> ● Default Gateway - Traffic will be sent to the default gateway address of the specified interface. ● Specific Gateway - Traffic will be sent to the specified gateway address instead of the default gateway address. <p>Packet Forwarding to WAN/LAN via - When you choose LAN/WAN (e.g., WAN1) as the Interface for packet transmission, you have to specify the way the packet forwarded to.</p> <ul style="list-style-type: none"> ● Force NAT - The source IP address will not be used to connect to the remote destination. Network Address Translation (NAT) will be used, where a common IP address will be used. ● Force Routing - The source IP address will be preserved when connecting to the remote destination. <p>Failover to - If the interface specified above loses connection, traffic can be forwarded to an alternate interface or be scrutinized by an alternate route policy.</p> <ul style="list-style-type: none"> ● WAN/LAN - Use the drop down list to choose an interface as an auto failover interface. ● VPN - Use the drop down list to choose a VPN tunnel as a failover tunnel. ● Route Policy - Use the drop down list to choose an existed route policy profile. ● Gateway - The failed-over traffic can be sent to the Default Gateway of the alternate interface/route policy, or a Specific Gateway at the specified IP address. <p>Failback- When Failover to option is enabled, Administrator could also enable Failback to clear the existing session on Failover interface and return to the original interface immediately once the original interface resume its service. When Failback is not enabled, the router will only stop sending packets via the Failover interface when the existing sessions are cleared, and this might take a long time because some application will keep sending packet once a while. Therefore, Failback option is recommended if Administrator wants the traffic to go via the primary interface as soon as possible.</p>
<p>Priority</p>	<p>Specifies the priority of the rule in relation to other rules. Lowering the priority value increases the priority of the rule, and vice versa. Routes in the routing table have a priority value of 150, whereas the default routes have a priority value of 250.</p> <p>The default priority value of Load Balance/Route Policy rules is 200. To change the priority, move the slider or enter a value.</p>

- When you finish the configuration, please click OK to save and exit this page.

Routing >> Load-Balance/Route Policy ?

Load-Balance/Route Policy 10 rules per page | [Set to Factory Default](#) | [Diagnose](#) |

Index	Enable	Comment	Protocol	Interface	Priority	Src IP Start	Src IP End	Dest IP Start	Dest IP End	Dest Port Start	Dest Port End	Move Up	Move Down
1	<input checked="" type="checkbox"/>		Any	WAN1	200	Any	Any	Any	Any	Any	Any		Down
2	<input checked="" type="checkbox"/>	test	TCP/UDP	WAN1	200	172.16.0.0	172.16.255.255	192.168.1.61	192.168.1.66	Any	Any	UP	Down
3	<input type="checkbox"/>		Any	WAN1	200	Any	Any	Any	Any	Any	Any	UP	Down
4	<input type="checkbox"/>		Any	WAN1	200	Any	Any	Any	Any	Any	Any	UP	Down
5	<input type="checkbox"/>		Any	WAN1	200	Any	Any	Any	Any	Any	Any	UP	Down
6	<input type="checkbox"/>		Any	WAN1	200	Any	Any	Any	Any	Any	Any	UP	Down
7	<input type="checkbox"/>		Any	WAN1	200	Any	Any	Any	Any	Any	Any	UP	Down
8	<input type="checkbox"/>		Any	WAN1	200	Any	Any	Any	Any	Any	Any	UP	Down
9	<input type="checkbox"/>		Any	WAN1	200	Any	Any	Any	Any	Any	Any	UP	Down
10	<input type="checkbox"/>		Any	WAN1	200	Any	Any	Any	Any	Any	Any	UP	Down

<< 1-10 | 11-20 | 21-30 | 31-40 | 41-50 | 51-60 | 61-70 | 71-80 | 81-90 | 91-100 | 101-110 | 111-120 | 121-130 | 131-140 | 141-150 | 151-160 | 161-170 | 171-180 | 181-190 | 191-200 | 201-210 | 211-220 | 221-230 | 231-240 | 241-250 >> [Next >>](#)

Wizard Mode: most frequently used settings in three pages
 Advance Mode: all settings in one page

II-6-2-2 Diagnose for Route Policy

The Diagnose function allows you to determine how a specific type of traffic from a host to a destination will be routed, and which routes, route policies and load balance rules match the criteria of the traffic.

Force Routing

Failover to
 WAN/LAN VPN Route Policy
Gateway: Default Gateway Specific Gateway

Priority

Click **Diagnose**.

Analyze a single packet

Select this mode to make Vigor router analyze how a single packet will be sent by a route policy.

Diagnostics >> Route Policy Diagnosis

Test how the packets will be routed

Mode Analyze a single packet
 Analyze multiple packets by uploading an input file

Packet Information

Protocol
 Src IP
 Dst IP
 Dst Port

Available settings are explained as follows:

Item	Description
Packet Information	<p>Specify the nature of the packets to be analyzed by Vigor router.</p> <p>Protocol - Specify a protocol for diagnosis.</p> <p>Src IP - IP address of host where the traffic originates.</p> <ul style="list-style-type: none"> ● Specify an IP - One source IP address. ● Any IP- Source IP address is not specified. ● Subnet/IP Routed Subnet - Any source IP address on the specified subnet. <p>Dst IP - IP address of the destination host.</p> <ul style="list-style-type: none"> ● Specify an IP - One destination IP address. ● Any IP - Destination IP address is not specified. <p>Dst Port - Number of port to which the traffic is sent. This setting is only applicable to UDP and TCP protocols. Use the drop down list to specify the destination port.</p> <p>Analyze - Click to analyze and display routes, route policies and load balance rules with matching criteria. If required, click export analysis to export the result as a file.</p>

The following shows an analysis example. The packet matched the criteria of one route policy.

Diagnostics >> Route Policy Diagnosis ?

Test how the packets will be routed

Mode Analyze a single packet
 Analyze multiple packets by uploading an input file

Packet Information

Protocol: Any
 Src IP: Specify an IP (192.168.100.2)
 Dst IP: Specify an IP (172.16.2.191)
 Dst Port: Any Port

Analyze

Analysis

the packet → LAN →  WAN5 → The packet was sent via WAN5 according to the Static route "172.16.2.0/255.255.255.0 WAN5"

Vigor3910

Matched	Priority
172.16.2.0/255.255.255.0 WAN5	150

Matched	Priority	failovered
Route Policy 2	200	No

Analyze multiple packets by uploading an input file

Diagnostics >> Route Policy Diagnosis ?

Test how the packets will be routed

Mode Analyze a single packet
 Analyze multiple packets by uploading an input file

Input File
 未選擇任何檔案 ([download](#) an example input file)

Available settings are explained as follows:

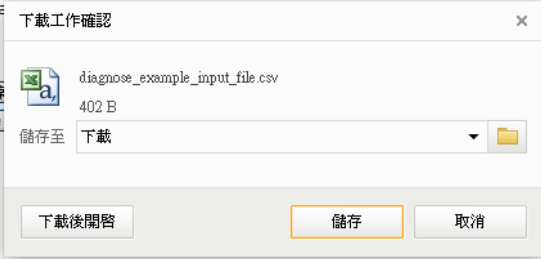
Item	Description
Input File	<p>Browse - Click to browse folder structure and select an input file.</p> <p>Download and example input file - Click to download a sample input file (blank ".csv" file). Then, click the Browse button to select that blank ".csv" file for saving the result of analysis.</p>  <p>Mode <input type="radio"/> analyze how a packet will be sent <input checked="" type="radio"/> analyze multiple packets by uploading an input file</p> <p>Input File <input type="button" value="選擇檔案"/> <input type="button" value="Analyze"/></p> <p>Analyze - After selecting input file, click to start the analysis process. Click the export button to export the result as a file.</p> <p>Note that the analysis was based on the current "load-balance/route policy" settings, we do not guarantee it will be 100% the same as the real case.</p>

The following shows the analysis of the sample input file. The matched routes and policies are highlighted in green. The Final Result column shows the outcome.



Test how the packets will be routed

- Mode Analyze a single packet
 Analyze multiple packets by uploading an input file

Input File

 未選擇任何檔案

[\(download an example input file\)](#)

Analysis

Profile	Input Packet Information				Matched Route		Matched Policy			Final Result	
	Proto	Src IP	Dst IP	Dst Port	Route	Priority	Policy	Priority	failovered	Interface	Reason
LA-branch	ICMP	192.168.1.10	10.10.10.10	Any	No Match	N/A	No Match	N/A	No	(null)	The packet was dropped because neither "route" or "policy" was matched
NY-branch	TCP	192.168.1.20	20.20.20.20	5060	No Match	N/A	No Match	N/A	No	(null)	The packet was dropped because neither "route" or "policy" was matched
NY7	UDP	192.168.1.20	20.20.20.20	5060	No Match	N/A	No Match	N/A	No	(null)	The packet was dropped because neither

II-6-3 Fast Routing

This function allows for establishing a network connection with a built-in acceleration engine. Time can be saved and CPU usage can be reduced.

Routing >> Fast Routing / NAT

Fast Routing / NAT

Fast Routing

Fast NAT

Level 1: Basic, ignore Session Limit.

Level 2: Include LV1 and skip Firewall.

Level 3: Include LV2 and bypass DNS.

Enable White List (Only specific subnets are allowed)

1. /24 ▼

2. /24 ▼

3. /24 ▼

4. /24 ▼

5. /24 ▼

6. /24 ▼

7. /24 ▼

8. /24 ▼

Enable Black List (Exclude these subnets)

Usage:

1. Use hardware fast path to help establish connections with the same source and destination ip.
2. Enable this function to reduce connection time and cpu usage.

Note:

Session limit and firewall port related settings may not work properly.

OK

Available settings are explained as follows:

Item	Description
Fast Routing	If enabled, the routing connection will be accelerated.
Fast NAT	<p>If enabled, the NAT connection will be accelerated.</p> <p>Level 1 to 3 - Select the type of Fast NAT. Each level represents different limit and condition.</p> <p>Enable White List - The fast NAT feature(accelerated) will be applied to the specified IP.</p> <ul style="list-style-type: none"> ● Item 1 to 8 - Enter the IP address and select the subnet mask. <p>Enable Black List - Forbid to apply the fast NAT feature to the specified IP.</p> <ul style="list-style-type: none"> ● Item 1 to 8 - Enter the IP address and select the subnet mask.

After finishing all the settings here, please click OK to save the configuration.

II-6-4 OSPF

OSPF(Open Shortest Path First), running within the AS, is a routing protocol based on IP protocol. It uses the algorithm of SPF (Shortest Path First) to calculate the route metric. It is suitable for large network and complicated data exchange. Vigor3912 supports up to OSPF version 2(only for IPv4).

The Autonomous System (AS) used in OSPF can be divided into several areas. Usually, Area 0 will be used as OSPF backbone which distributing the routing information among areas.

When you need faster convergence than distance vector, want to support much larger networks or want to have less susceptible to bad routing information, you can enable OSPF feature to fit your request. Note that both routers must support OSPF function at the same time to build the OSPF connection.

Open Routing >> OSPF to get the following page.

Routing >> OSPF

Basic Settings							View Routing Table
Local							
<input type="checkbox"/> Enable OSPF							
Profile							
Enable	Index	Interface	Area	MD5 Auth	Password	Key ID (1 - 255)	Neighborhoods
<input type="checkbox"/>	1	LAN 1	0	Disable		0	0
<input type="checkbox"/>	2	LAN 1	0	Disable		0	0
<input type="checkbox"/>	3	LAN 1	0	Disable		0	0
<input type="checkbox"/>	4	LAN 1	0	Disable		0	0
<input type="checkbox"/>	5	LAN 1	0	Disable		0	0
<input type="checkbox"/>	6	LAN 1	0	Disable		0	0
<input type="checkbox"/>	7	LAN 1	0	Disable		0	0
<input type="checkbox"/>	8	LAN 1	0	Disable		0	0
<input type="checkbox"/>	9	LAN 1	0	Disable		0	0
<input type="checkbox"/>	10	LAN 1	0	Disable		0	0
<input type="checkbox"/>	11	LAN 1	0	Disable		0	0

Available settings are explained as follows:

Item	Description
Local	
Enable OSPF	Check the box to enable the function.
Profile	
Enable	Check it to enable and configure an OSPF profile.
Index	1 to 64 indicates profile 1 to profile 64.
Interface	Choose a LAN / WAN interface to apply the settings configured for this profile.
Area	An AS will be divided into several areas. Each area must be assigned with a dedicated number.
MD5 Auth	Enable/disable the MD5 authentication mechanism for such profile.
Password	Enter characters as the password for MD5 authentication.
Key ID (1-255)	Specify the IP address of such Vigor router. Such ID will help Vigor router to be identified in an autonomous system. However, if no address is specified, then an IP address of the active interface will be used by

	system automatically.
Neighborhoods	Displays current neighbors status in BGP routing environment.

When you finish the configuration, please click **OK** to save and exit this page.

II-6-5 BGP

BGP means Border Gateway Protocol. It is a standardized exterior gateway protocol which can exchange routing and reachability information between autonomous systems (AS) on Internet.

The protocol TCP is used by two routers supporting BGP for data transmission. They can exchange the BGP routing information for each other. A BGP router is the “neighbor” of other BGP routers. Define the IP address, AS number for the router is essential for TCP connection of BGP routing information exchange.

AS, the abbreviation of Autonomous System, is a group interconnected with multiple IP addresses. Each AS shall be assigned with one AS number (ASN). The ASN is a unique identifier for AS to distinguish each network group in the whole interconnected network. It can be operated by one or several ISPs and follows the routing policies made by ISP.

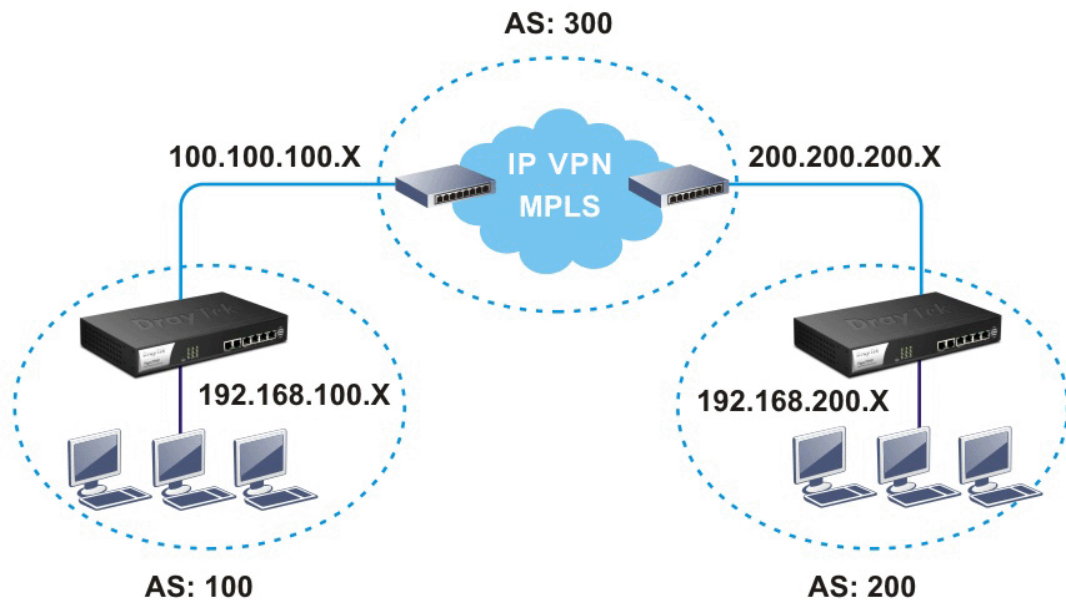

II-6-4-1 Basic Settings

Set general settings for for local router and neighboring routers.

Routing >> BGP

Basic Settings		Static Network		Refresh	View Routing Table	
Local						
<input type="checkbox"/> Enable BGP						
Local AS Number	<input type="text" value=""/>	(1~4294967295)				
Hold Time	<input type="text" value="180"/>	(10~65535 Sec)				
Connect Retry Time	<input type="text" value="120"/>	(3~255 Sec)				
Router ID	<input type="text" value="192.168.1.1"/>	(e.g. 1.2.3.4)				
Neighbor						
Index	Enable	AS Number	Profile Name	IP Address	MD5 Auth	Status
1	<input type="checkbox"/>					None
2	<input type="checkbox"/>					None
3	<input type="checkbox"/>					None
4	<input type="checkbox"/>					None
5	<input type="checkbox"/>					None
6	<input type="checkbox"/>					None
7	<input type="checkbox"/>					None
8	<input type="checkbox"/>					None
9	<input type="checkbox"/>					None

Available settings are explained as follows:

Item	Description
Local	
Enable BGP	Check the box to enable basic BGP function for local router.
Local AS Number	Set the AS number for local router.
Hold Time	Set the time interval (in seconds) to determine the peer is dead when the router is unable to receive any keepalive message from the peer within the time.
Connect Retry Time	If the router fails to connect to neighboring router, it requires a period of time to reconnect. Set the time interval to do reconnection.
Router ID	Specify the LAN subnet for the router.
Neighbor	
Index	Click the index number link to configure neighbor profile.
Enable	Check the box to enable the basic BGP function for neighboring router.
AS Number	Display the AS Number for neighboring router.
Profile Name	Display the name of the neighboring profile.
IP Address	Display the IP address specified for the neighboring profile.
MD5 Auth	Display the status (enable or disable) of MD5 Auth.
Status	Display the connection status for local router and neighboring router.

When you finish the configuration, please click **OK** to save and exit this page.

II-6-4-2 Static Network

This page allows you to configure up to eight neighboring routers for exchanging the routing information with the local router.

Routing >> BGP

Basic Settings		Static Network		View Routing Table
Select	Index	IP Address	Subnet Mask	
<input type="checkbox"/>	1	<input type="text"/>	255.255.255.254 / 31 ▼	
<input type="checkbox"/>	2	<input type="text"/>	255.255.255.254 / 31 ▼	
<input type="checkbox"/>	3	<input type="text"/>	255.255.255.254 / 31 ▼	
<input type="checkbox"/>	4	<input type="text"/>	255.255.255.254 / 31 ▼	
<input type="checkbox"/>	5	<input type="text"/>	255.255.255.254 / 31 ▼	
<input type="checkbox"/>	6	<input type="text"/>	255.255.255.254 / 31 ▼	
<input type="checkbox"/>	7	<input type="text"/>	255.255.255.254 / 31 ▼	
<input type="checkbox"/>	8	<input type="text"/>	255.255.255.254 / 31 ▼	
<input type="checkbox"/>	9	<input type="text"/>	255.255.255.254 / 31 ▼	
<input type="checkbox"/>	10	<input type="text"/>	255.255.255.254 / 31 ▼	
<input type="checkbox"/>	11	<input type="text"/>	255.255.255.254 / 31 ▼	
<input type="checkbox"/>	12	<input type="text"/>	255.255.255.254 / 31 ▼	
<input type="checkbox"/>	13	<input type="text"/>	255.255.255.254 / 31 ▼	
<input type="checkbox"/>	14	<input type="text"/>	255.255.255.254 / 31 ▼	

Available settings are explained as follows:

Item	Description
Select	Check the box to enable the configuration for the selected index entry.
IP Address	Enter the IP address for a router.
Subnet Mask	Choose the mask value for the IP address.

Application Notes

A-1 How to Customize a Secure Route between VPN Router and Remote Router by Using Route Policy

Example 1:

In the following figure, a LAN to LAN VPN tunnel is built between DrayTek VPN router (e.g., Vigor3912 Series) and the remote router. Firewall Router can receive all of the traffic coming from remote PC which wants to access into Internet; and send back the packets to Remote Router through VPN Router.

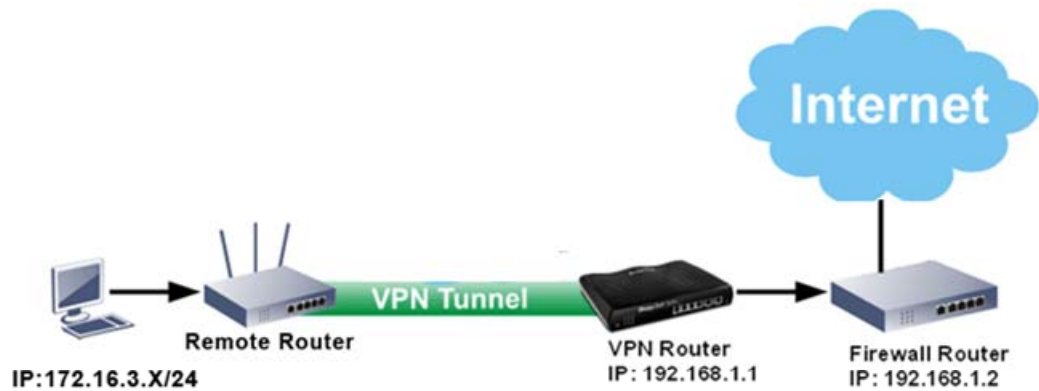

1. Establish a VPN tunnel between VPN Router and the Remote Router.
2. Change to default route for the router located in Remote Router.
3. Access into the web user interface of the router in VPN Router. Then, open **Routing >> Load-Balance / Route Policy** and click **Advance Mode**.

Routing >> Load-Balance/Route Policy



Load-Balance/Route Policy

10 rules per page

[Set to Factory Default](#)

[Diagnose](#)

Index	Enable	Comment	Protocol	Interface	Priority	Src IP Start	Src IP End	Dest IP Start	Dest IP End	Dest Port Start	Dest Port End	Move Up	Move Down
1	<input type="checkbox"/>		Any	WAN5	200	Any	Any	192.168.18.18	192.168.18.18	Any	Any		Down
2	<input type="checkbox"/>		Any	WAN3	200	Any	Any	Any	Any	Any	Any	UP	Down
3	<input type="checkbox"/>		Any	WAN1	200	Any	Any	Any	Any	Any	Any	UP	Down
4	<input type="checkbox"/>		Any	WAN1	200	Any	Any	Any	Any	Any	Any	UP	Down
5	<input type="checkbox"/>		Any	WAN1	200	Any	Any	Any	Any	Any	Any	UP	Down
6	<input type="checkbox"/>		Any	WAN1	200	Any	Any	Any	Any	Any	Any	UP	Down
7	<input type="checkbox"/>		Any	WAN1	200	Any	Any	Any	Any	Any	Any	UP	Down
8	<input type="checkbox"/>		Any	WAN1	200	Any	Any	Any	Any	Any	Any	UP	Down
9	<input type="checkbox"/>		Any	WAN1	200	Any	Any	Any	Any	Any	Any	UP	Down
10	<input type="checkbox"/>		Any	WAN1	200	Any	Any	Any	Any	Any	Any	UP	Down

<< 1-10 | 11-20 | 21-30 | 31-40 | 41-50 | 51-60 | 61-70 | 71-80 | 81-90 | 91-100 | 101-110 | 111-120 | 121-130 | 131-140 | 141-150 | 151-160 | 161-170 | 171-180 | 181-190 | 191-200 | 201-210 | 211-220 | 221-230 | 231-240 | 241-250 >>

Wizard Mode: most frequently used settings in three pages

Advance Mode: all settings in one page

OK

- Click any **Index** number link (e.g., 1 in this case). Configure the settings as follows.

Routing >> Load-Balance/Route Policy

Index: 1

Enable

Comment

Criteria

Protocol

Source

Destination Start: End:

Destination Port

Send via if Criteria Matched

Interface WAN/LAN VPN

Gateway Default Gateway Specific Gateway

Packet Forwarding to WAN/LAN via Force NAT Force Routing

Failover to WAN/LAN VPN Route Policy Gateway Default Gateway Specific Gateway

Priority

Now, if you want such route policy will be applied by Vigor router with higher priority, please adjust the value of **Priority** for such route policy. In general, default route is specified with the lowest priority for it value is fixed as "250". And Routes in Routing Table are fixed as "150". You can adjust the value for such route policy with lower value, e.g., 100 to ensure it will be applied to packets transmission with the highest priority.

- After finished the above settings, click **OK** to save the configuration.

Routing >> Load-Balance/Route Policy



Load-Balance/Route Policy 10 rules per page | [Set to Factory Default](#) | [Diagnose](#)

Index	Enable	Comment	Protocol	Interface	Priority	Src IP Start	Src IP End	Dest IP Start	Dest IP End	Dest Port Start	Dest Port End	Move Up	Move Down
1	<input type="checkbox"/>		Any	WAN5	200	Any	Any	192.168.18.18	192.168.18.18	Any	Any		Down
2	<input type="checkbox"/>		Any	WAN3	200	Any	Any	Any	Any	Any	Any	UP	Down
3	<input type="checkbox"/>		Any	WAN1	200	Any	Any	Any	Any	Any	Any	UP	Down
4	<input type="checkbox"/>		Any	WAN1	200	Any	Any	Any	Any	Any	Any	UP	Down
5	<input type="checkbox"/>		Any	WAN1	200	Any	Any	Any	Any	Any	Any	UP	Down
6	<input type="checkbox"/>		Any	WAN1	200	Any	Any	Any	Any	Any	Any	UP	Down
7	<input type="checkbox"/>		Any	WAN1	200	Any	Any	Any	Any	Any	Any	UP	Down
8	<input type="checkbox"/>		Any	WAN1	200	Any	Any	Any	Any	Any	Any	UP	Down

- To route the packets coming from the Firewall Router back to the remote router, access into the web user interface of the Firewall Router. Then, set "192.168.1.1/24" as the gateway IP address and set "172.16.3.0/24" as the destination IP address.

Example 2:

Below shows a scenario that local users behind Vigor router A want to access into a remote service (e.g., YouTube) which is blocked or restricted by local Service Provider in area with restrictions. A policy route can be created by the side of Router A to break through the Internet censorship circumvention.

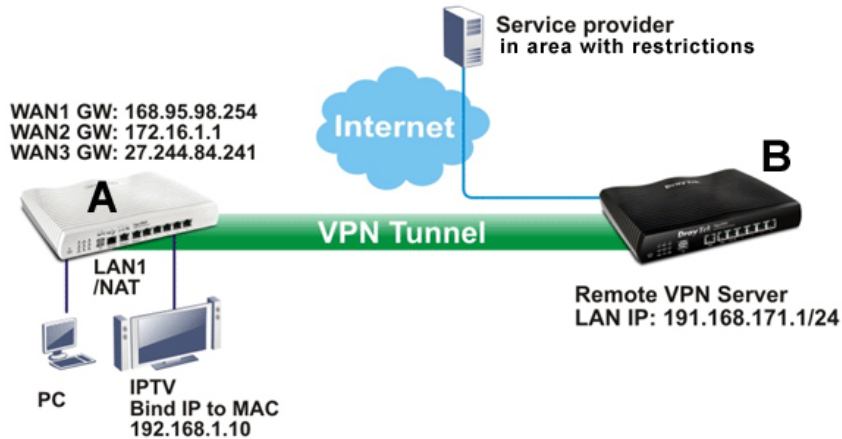

A VPN tunnel has been established between Router A and router B.

1. Access into the web user interface of Router A.
2. Open **Routing >> Load-Balance/Route Policy** and click **Advance Mode**.
3. Click any index number (e.g., #1 in this case).
4. In the following web page, check **Enable**; type "192.168.1.10" as **Src IP Range**; type "213.57.89.100" as the **Destination IP** for the remote VPN server; and choose **VPN** as the **Interface** setting.

Routing >> Load-Balance/Route Policy

Index: 1

<input checked="" type="checkbox"/> Enable
Comment: 測試2962用 Delete
Criteria
Protocol: Any
Source: IP Range Start: 192.168.1.10 End: 192.168.1.10
Destination: IP Range Start: 213.57.89.100 End: 213.57.89.100
Destination Port: Any
Send via if Criteria Matched
Interface: <input checked="" type="radio"/> WAN/LAN (WAN1) <input type="radio"/> VPN (None)
Gateway: <input type="radio"/> Default Gateway <input checked="" type="radio"/> Specific Gateway (192.168.1.2)
Packet Forwarding to WAN/LAN via: <input checked="" type="radio"/> Force NAT <input type="radio"/> Force Routing
Failover to: <input type="checkbox"/> Failover to <input checked="" type="radio"/> WAN/LAN (Default WAN) <input type="radio"/> VPN (None) <input type="radio"/> Route Policy (Index 1)
Gateway: <input checked="" type="radio"/> Default Gateway <input type="radio"/> Specific Gateway (0.0.0.0)
Priority

OK Clear Cancel Diagnose

5. Click **OK** to save the settings.

Part III VPN



VPN



SSL VPN



Certificate
Management

A Virtual Private Network (VPN) is the extension of a private network that encompasses links across shared or public networks like the Internet. In short, by VPN technology, you can send data between two computers across a shared or public network in a manner that emulates the properties of a point-to-point private link.

It is a form of VPN that can be used with a standard Web browser.

A digital certificate works as an electronic ID, which is issued by a certification authority (CA). It contains information such as your name, a serial number, expiration dates etc., and the digital signature of the certificate-issuing authority so that a recipient can verify that the certificate is real. Here Vigor router support digital certificates conforming to standard X.509.

III-1 VPN and Remote Access

A Virtual Private Network (VPN) is the extension of a private network that encompasses links across shared or public networks like the Internet. In short, by VPN technology, you can send data between two computers across a shared or public network in a manner that emulates the properties of a point-to-point private link.

The VPN built is suitable for:

- Communication between home office and customer
- Secure connection between Teleworker, staff on business trip and main office
- Exchange data between remote office and main office
- POS between chain store and headquarters

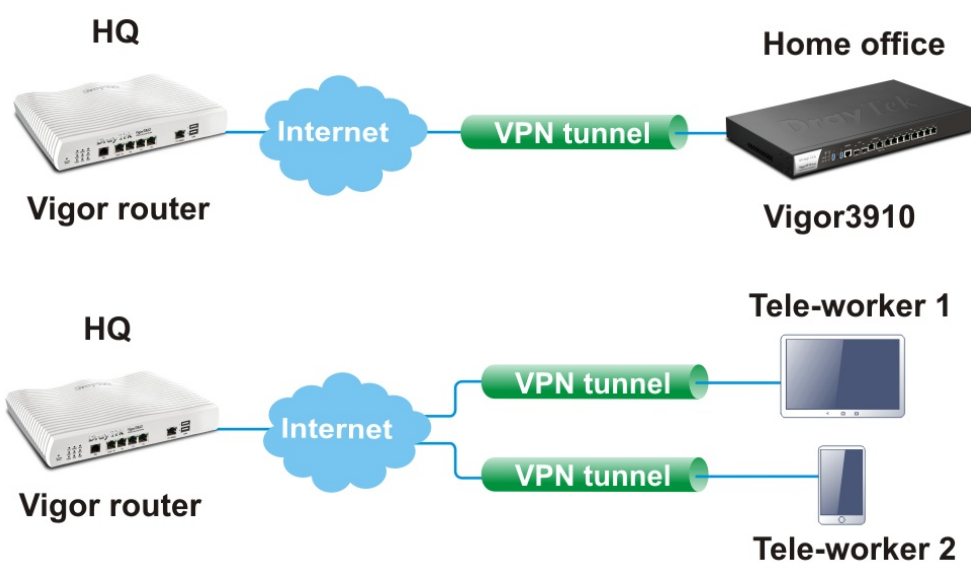

Web User Interface

Applications
VPN and Remote Access
Remote Access Control
PPP General Setup
SSL General Setup
IPsec General Setup
IPsec Peer Identity
VPN Matcher Setup
OpenVPN
WireGuard
Remote Dial-in User
LAN to LAN
VPN TRUNK Management
Connection Management
Certificate Management

III-1-1 Remote Access Control

Enable the necessary VPN service as you need. If you intend to run a VPN server inside your LAN, you should disable the VPN service of Vigor Router to allow VPN tunnel pass through, as well as the appropriate NAT settings, such as DMZ or open port.

III-1-1-1 Remote Access Control Setup

VPN and Remote Access >> Remote Access Control

Remote Access Control Setup	Bind to WAN
<input type="checkbox"/> Enable PPTP VPN Service <input type="checkbox"/> Enable IPsec VPN Service <input type="checkbox"/> Enable L2TP VPN Service <input type="checkbox"/> Enable SSL VPN Service <input type="checkbox"/> Enable OpenVPN Service <input type="checkbox"/> Enable WireGuard VPN Service	

Note:

1. To allow VPN pass-through to a separate VPN server on the LAN, disable the services listed above that use the same protocol and ensure that NAT [Open Ports](#) or [Port Redirection](#) is well-configured.
2. Disable unused VPN services, enable [Brute Force Protection](#), and [block unknown IP access](#) to the used VPN services to reduce Cyberattacks.

OK Clear Cancel

Item	Description
Enable PPTP VPN Service	This is the one of the earliest VPN protocols and is natively supported by all Microsoft Windows versions since Windows 95, all Android devices, iOS devices before version 10, and Mac OS X before version 10.12. It is easy to set up, has low overhead, and moderately secure.
Enable IPsec VPN Service	This is a network protocol that encrypts traffic between two network locations. Windows, by means of Windows Firewall, natively supports IPsec tunnels between endpoints with static IP addresses. For computers with dynamically-assigned IP addresses, DrayTek provides the SmartVPN client .
Enable L2TP VPN Service	This is a tunneling protocol used in VPNs. It does not encrypt network traffic unless used in conjunction with IPsec.
Enable SSL VPN Service	This type of VPN uses Secure Sockets Layer (SSL) and Transport Layer Security (TLS), which are also used to encrypt traffic to and from websites. Since SSL and TLS work on top of TCP and UDP, which are the most common internet protocols, they are less likely to be have issues with firewalls and gateways.
Enable OpenVPN Service	OpenVPN is an open-source VPN technique and could authenticate each other using pre-shared secret keys, certificates, or username/password.
Enable WireGuard VPN Service	WireGuard is a secure, fast, and modern open-source VPN Protocol. This type of VPN connection is made by exchanging public keys and intends to be considerably more performant than OpenVPN.

To save changes on the page, select **OK**; to discard changes, select **Cancel**; to clear settings on this page and revert to default settings, select **Clear**.

III-1-1-2 Bind to WAN

Select the WAN interfaces to accept PPTP VPN, IPsec VPN, L2TP VPN, inbound SSL VPN, OpenVPN and WireGuard connections.

VPN and Remote Access >> Remote Access Control

Remote Access Control Setup		Bind to WAN					
PPTP VPN Service	<input checked="" type="checkbox"/> WAN1	<input checked="" type="checkbox"/> WAN3	<input checked="" type="checkbox"/> WAN5	<input checked="" type="checkbox"/> WAN6	<input checked="" type="checkbox"/> WAN7	<input checked="" type="checkbox"/> WAN8	
IPsec VPN Service	<input checked="" type="checkbox"/> WAN1	<input checked="" type="checkbox"/> WAN3	<input checked="" type="checkbox"/> WAN5	<input checked="" type="checkbox"/> WAN6	<input checked="" type="checkbox"/> WAN7	<input checked="" type="checkbox"/> WAN8	
L2TP VPN Service	<input checked="" type="checkbox"/> WAN1	<input checked="" type="checkbox"/> WAN3	<input checked="" type="checkbox"/> WAN5	<input checked="" type="checkbox"/> WAN6	<input checked="" type="checkbox"/> WAN7	<input checked="" type="checkbox"/> WAN8	
SSL VPN Service	<input checked="" type="checkbox"/> WAN1	<input checked="" type="checkbox"/> WAN3	<input checked="" type="checkbox"/> WAN5	<input checked="" type="checkbox"/> WAN6	<input checked="" type="checkbox"/> WAN7	<input checked="" type="checkbox"/> WAN8	
OpenVPN Service	<input checked="" type="checkbox"/> WAN1	<input checked="" type="checkbox"/> WAN3	<input checked="" type="checkbox"/> WAN5	<input checked="" type="checkbox"/> WAN6	<input checked="" type="checkbox"/> WAN7	<input checked="" type="checkbox"/> WAN8	
WireGuard Service	<input checked="" type="checkbox"/> WAN1	<input checked="" type="checkbox"/> WAN3	<input checked="" type="checkbox"/> WAN5	<input checked="" type="checkbox"/> WAN6	<input checked="" type="checkbox"/> WAN7	<input checked="" type="checkbox"/> WAN8	

III-1-2 PPP General Setup

This page allows configuration of Point-to-Point Protocol (PPP) used by PPTP and L2TP VPN connections. From the Main Menu select **VPN and Remote Access >> PPP General Setup** to bring up the following configuration page.

VPN and Remote Access >> PPP General Setup

PPP General Setup		
PPP/MP Protocol Dial-In PPP Authentication: <input type="text" value="PAP/CHAP/MS-CHAP/MS-CHAPv2"/>		
Dial-In PPP Encryption(MPPE): <input type="text" value="Optional MPPE"/>		
Mutual Authentication (PAP): <input type="radio"/> Yes <input checked="" type="radio"/> No		
Username: <input type="text" value="Max: 128 characters"/>		
Password: <input type="text" value="Max: 128 characters"/>		
IP Address Assignment for Dial-In Users when DHCP is disabled.		
LAN 1	Start IP Address: <input type="text" value="192.168.1.200"/>	IP Pool Counts: <input type="text" value="50"/>
PPP Authentication Methods <input checked="" type="checkbox"/> Remote Dial-in User <input checked="" type="checkbox"/> RADIUS <input checked="" type="checkbox"/> AD/LDAP LDAP Profile <input checked="" type="checkbox"/> TACACS+		
VPN Two-Factor Authentication for AD/ LDAP <input type="checkbox"/> Authentication Code via Email Email Object: <input type="text" value="1-???"/>		
<input type="checkbox"/> Authentication Code via SMS SMS Object: <input type="text" value="1-???"/>		
<input type="checkbox"/> Time-based One-time Password (TOTP) <input type="checkbox"/> LDAP Attribute for TOTP Secret: <input type="text" value="LDAP Attribute"/>		
<input type="checkbox"/> Shared Secret: <input type="text" value="All users share this Secret"/>		
<input type="button" value="Regenerate"/> <input type="button" value="Copy"/>		
While using RADIUS or LDAP authentications: Assign IP from subnet: <input type="text" value="LAN1"/>		
VPN TCP maximum segment size (MSS) PPTP: <input type="text" value="1360"/> (512~1412) L2TP: <input type="text" value="1360"/> (512~1408) SSL: <input type="text" value="1260"/> (512~1360)		

Note:

1. Please select 'PAP Only' Dial-In PPP Authentication, if you want to use AD/LDAP or TACACS+ for PPP Authentication.
2. Default priority is Remote Dial-in User -> RADIUS -> AD/LDAP -> TACACS+.
3. Vigor router also supports Framed-IP-Address from RADIUS server to assign IP address to VPN client.

OK

Available settings are explained as follows:

Item	Description
Dial-In PPP Authentication	<p>PAP Only - Authenticate dial-in users using the PAP protocol only.</p> <p>PAP/CHAP/MS-CHAP/MS-CHAPv2 - Attempt to authenticate dial-in users using various CHAP protocols, and if the remote VPN client fails to authenticate, fall back to PAP.</p>
Dial-In PPP Encryption (MPPE)	<p>Specifies if PPP encryption (MPPE) is to be used for dial-in VPN connections.</p> <p>Optional MPPE - MPPE is optional. If the VPN client supports MPPE, PPP data will be encrypted.</p> <p>Require MPPE (40/128bits) - Require PPP encryption for dial-in VPN connections. Both 40- and 128-bit encryption schemes are allowed. The remote dial-in user will use 40-bit to perform encryption prior to using 128-bit for encryption. In other words, if 128-bit MPPE encryption method is not available, then 40-bit encryption scheme will be applied to encrypt the data.</p> <p>Maximum MPPE - Require 128-bit PPP encryption for all dial-in VPN connections.</p>

<p>Mutual Authentication (PAP)</p>	<p>Specifies if mutual authentication is to be used. Some VPN peers (e.g., certain Cisco routers) require bi-directional authentication used for providing stronger security.</p> <p>When mutual authentication is enabled, Username and Password fields should also be populated using values from the VPN peer. The maximum lengths of these fields are 23 and 19 characters, respectively.</p> <p>Yes - Enable mutual authentication. No - Disable mutual authentication.</p>
<p>IP Address Assignment for Dial-In Users when DHCP is disabled</p>	<p>LAN1 - When the router's DHCP server is disabled, the router will assign IP addresses to dial-in VPN users starting with the IP address specified in Start IP Address. The total number of dial-in VPN IP addresses to be given out is specified in IP Pool Counts.</p> <p>LAN# will be available if it is enabled. Refer to LAN>>General Setup for enabling the LAN interface.</p>
<p>PPP Authentication Methods</p>	<p>The credentials to be used for PPP authentication will be obtained from the selected sources, in the following order:</p> <p>Remote Dial-in User - The usernames and passwords in VPN and Remote Access >> Remote Dial-in User section will be used.</p> <p>RADIUS - An external RADIUS server is to be used for authentication. Please be sure to set up the RADIUS server in Applications >> RADIUS/TACACS+ section.</p> <p>AD/LDAP - An Active Directory/LDAP server is to be used for authentication. Please be sure to configure AD and LDAP settings in Applications >> Active Directory/LDAP.</p> <p>TACACS+ - A TACACS+ server is to be used for authentication. Please be sure to set up the RADIUS server in Applications >> RADIUS/TACACS+ section.</p>
<p>LDAP Profile</p>	<p>Configured LDAP profiles will be listed under such item. Simply check the one you want to enable the PPP authentication by LDAP server profiles.</p> <p>However, if there is no profile listed, simply click the link of LDAP Profile to create/add some new LDAP profiles you want.</p>
<p>VPN Two-Factor Authentication for AD/LDAP</p>	<p>Vigor router offers three methods of two-factor authentication solution for customers using AD/LDAP to authenticate remote dial-in VPN clients. It can add extra layer of security for VPN connection.</p> <p>Authentication Code via Email - Before selecting, make sure mail attribute configured with the email address in your AD/LDAP account. Check the box and select a mail server profile (with customized username and password) to send the two-factor authentication code via an e-mail.</p> <p>Authentication Code via SMS - Before selecting, make sure the mobile attribute configured with the the recipient number in your AD/LDAP account. Check the box and select an SMS provider profile (with customized username and password) to send the two-factor authentication code via an SMS.</p> <p>Time-based One-time Password (TOTP) - Select to configure the TOTP secret and/or Shared Secret. These two secretes will be used for generate a number for two-factor authentication via an Authenticator App.</p>

	<p>VPN Two-Factor Authentication for AD/ LDAP</p> <p><input type="checkbox"/> Authentication Code via Email Email Object 1 - mail_carrie ▾</p> <p><input type="checkbox"/> Authentication Code via SMS SMS Object 1 - mailforuse ▾</p> <p><input checked="" type="checkbox"/> Time-based One-time Password (TOTP)</p> <p><input checked="" type="checkbox"/> LDAP Attribute for TOTP Secret: pager</p> <p><input checked="" type="checkbox"/> Shared Secret: JYWESV2IPBHGIV3QNVRDK6LON5EEUWDE</p> <p>Regenerate Copy</p>  <p>LDAP Attribute for TOTP Secret - The default setting is "pager". If you want to change the attribute name, make sure that one used for saving the TOTP secret has been configured with TOTP secret in your AD/LDAP account.</p> <p>Shared Secret - Select to enable the shared secret. If no secret attribute is defined for the AD/LDAP account, select to use the default codes for generating the TOTP.</p> <p>Regenerate - Click to regenerate a new shared secret.</p> <p>Copy - Click to copy the shared secret.</p>
<p>While using RADIUS or LDAP authentications</p>	<p>When the dial-in VPN user is authenticated using credentials from the Remote Dial-in User section, an IP address from the LAN specified in the user profile will be assigned. When the user is authenticated using credentials from other sources (RADIUS, AD, TACACS+), the assigned IP address will be drawn from the address pool of the LAN specified here.</p>
<p>VPN TCP maximum segment size (MSS)</p>	<p>Set the maximum segment size (MSS) for different VPN types. Please specify the MSS values for each type to avoid packets cut by MTU during the data transmission period via the IPsec VPN connection.</p>

After finishing all the settings here, please click **OK** to save the configuration.

III-1-3 SSL General Setup

SSL VPN (Secure Sockets Layer virtual private network) is a form of VPN that encrypts traffic using SSL, which is the same technology used on secured websites. Because of SSL's prominence as an encryption protocol on the Internet, most networks have few restrictions on SSL traffic, and as a result SSL VPN is more likely to work when other VPN technologies experience difficulties due to obstacles such as firewalls and Network Address Translation (NAT).

In short,

- It is not necessary for users to preinstall VPN client software for executing SSL VPN connection.
- There are less restrictions for the data encrypted through SSL VPN in comparing with traditional VPN.

This page determines the general configuration for SSL VPN Server and SSL Tunnel.

VPN and Remote Access >> SSL General Setup

SSL General Setup

Bind to WAN	<input checked="" type="checkbox"/> WAN1	<input checked="" type="checkbox"/> WAN3	<input checked="" type="checkbox"/> WAN5	<input checked="" type="checkbox"/> WAN6	<input checked="" type="checkbox"/> WAN7	<input checked="" type="checkbox"/> WAN8
Port	<input type="text" value="443"/>	(Default: 443)				
Server Certificate	<input type="text" value="self-signed"/>					

Available settings are explained as follows:

Item	Description
Bind to WAN	Select the WAN interfaces to accept inbound SSL VPN connections.
Port	The port to be used for SSL VPN server. This is separate from the management port (HTTPS Port) which is configured in System Maintenance>>Management . The default setting is 443.
Server Certificate	Specify the certificate to be used for SSL connections. Select a certificate from imported or generated certificates on the router, or choose Self-signed to use the router's built-in default certificate. The selected certificate can be used in SSL VPN server and HTTPS Web Proxy.

To save changes on this page, select **OK**; to discard changes, select **Cancel**.

III-1-4 IPsec General Setup

In IPsec General Setup, there are two major parts of configuration.

There are two phases of IPsec.

- Phase 1: negotiation of IKE parameters including encryption, hash, Diffie-Hellman parameter values, and lifetime to protect the following IKE exchange, authentication of both peers using either a Pre-Shared Key or Digital Signature (x.509). The peer that starts the negotiation proposes all its policies to the remote peer and then remote peer tries to find a highest-priority match with its policies. Eventually to set up a secure tunnel for IKE Phase 2.
- Phase 2: negotiation IPsec security methods including Authentication Header (AH) or Encapsulating Security Payload (ESP) for the following IKE exchange and mutual examination of the secure tunnel establishment.

There are two encapsulation methods used in IPsec, **Transport** and **Tunnel**. The **Transport** mode will add the AH/ESP payload and use original IP header to encapsulate the data payload only. It can just apply to local packet, e.g., L2TP over IPsec. The **Tunnel** mode will not only add the AH/ESP payload but also use a new IP header (Tunneled IP header) to encapsulate the whole original IP packet.

Authentication Header (AH) provides data authentication and integrity for IP packets passed between VPN peers. This is achieved by a keyed one-way hash function to the packet to create a message digest. This digest will be put in the AH and transmitted along with packets. On the receiving side, the peer will perform the same one-way hash on the packet and compare the value with the one in the AH it receives.

Encapsulating Security Payload (ESP) is a security protocol that provides data confidentiality and protection with optional authentication and replay detection service.

VPN IKE/IPsec General Setup

(Dial-in settings for Remote Dial-In users and LAN-to-LAN VPN Client with Dynamic IP.)

IKE Authentication Method	
Certificate	None
Preferred Local ID	Alternative Subject Name
General Pre-Shared Key	Max: 128 characters
Confirm General Pre-Shared Key	Max: 128 characters
XAuth User Pre-Shared Key	Max: 63 characters
Confirm XAuth User Pre-Shared Key	Max: 63 characters
IPsec Security Method	
<input checked="" type="radio"/> Basic <input type="radio"/> Medium <input type="radio"/> High	Encryption: AES/3DES/DES HMAC: SHA256/SHA1/MD5 DH Group: G21/G20/G19/G14/G5/G2/G1 AH: <input checked="" type="checkbox"/> Enable
VPN TCP maximum segment size (MSS)	
IPsec (IKEv1/IKEv2)	1360 (512~1381)
L2TP over IPsec	1360 (512~1361)
GRE over IPsec	1360 (512~1365)

OK Cancel

Available settings are explained as follows:

Item	Description
IKE Authentication Method	<p>This usually applies to those are remote dial-in user or node (LAN-to-LAN) which uses dynamic IP address and IPsec-related VPN connections such as L2TP over IPsec and IPsec tunnel. There are two methods offered by Vigor router for you to authenticate the incoming data coming from remote dial-in user, Certificate (X.509) and Pre-Shared Key.</p> <p>Certificate - X.509 certificates can be used for IKE authentication. To set up certificates on the router, go to the Certificate Management section.</p> <p>Preferred Local ID - Specify the preferred local ID information (Alternative Subject Name First or Subject Name First) for IPsec authentication while the client is using the general setting (without a specific Peer IP or ID in the VPN profile).</p> <p>General Pre-Shared Key- Define the PSK key for general authentication.</p> <p>Confirm General Pre-Shared Key- Re-enter the characters to confirm the pre-shared key.</p> <p>XAuth User Pre-Shared Key - Define the PSK key for IPsec XAuth authentication.</p> <p>Confirm XAuth User Pre-Shared Key- Re-enter the</p>

	<p>characters to confirm the pre-shared key for IPsec XAuth authentication.</p> <p>Note: Any packets from the remote dial-in user which does not match the rule defined in VPN and Remote Access>>Remote Dial-In User will be applied with the method specified here.</p>
IPsec Security Method	<p>Available methods include Basic, Medium and High. Each method offers different encryption, HMAC and DH Group.</p> <p>Basic - Authentication Header (AH) means data will be authenticated, but not be encrypted. By default, this option is active.</p> <p>Medium - When this option is selected, the Authentication Header (AH) protocol can be used to provide authentication to IPsec traffic.</p> <p>High - When this option is selected, the Encapsulating Security Payload (ESP) protocol can be used to provide authentication and encryption to IPsec traffic. Three encryption standards are supported for ESP: DES, 3DES and AES, in ascending order of security.</p>
VPN TCP maximum segment size (MSS)	<p>Set the maximum segment size (MSS) for different VPN types. Please specify the MSS values for each type to avoid packets cut by MTU during the data transmission period via the IPsec VPN connection.</p>

After finishing all the settings here, please click **OK** to save the configuration.

III-1-5 IPsec Peer Identity

This screen allows creating profiles of subject alternative names (SANs) and distinguished names/subject names that can be used for IPsec peer authentication in LAN-to-LAN or remote user dial-in VPN connections.

VPN and Remote Access >> IPsec Peer Identity

X509 Peer ID Accounts: | [Set to Factory Default](#) |

Index	Enable	Name	Index	Enable	Name
1.	<input checked="" type="checkbox"/>	bb	17.	<input type="checkbox"/>	???
2.	<input type="checkbox"/>	???	18.	<input type="checkbox"/>	???
3.	<input type="checkbox"/>	???	19.	<input type="checkbox"/>	???
4.	<input type="checkbox"/>	???	20.	<input type="checkbox"/>	???
5.	<input type="checkbox"/>	???	21.	<input type="checkbox"/>	???
6.	<input type="checkbox"/>	???	22.	<input type="checkbox"/>	???
7.	<input type="checkbox"/>	???	23.	<input type="checkbox"/>	???
8.	<input type="checkbox"/>	???	24.	<input type="checkbox"/>	???
9.	<input type="checkbox"/>	???	25.	<input type="checkbox"/>	???
10.	<input type="checkbox"/>	???	26.	<input type="checkbox"/>	???
11.	<input type="checkbox"/>	???	27.	<input type="checkbox"/>	???
12.	<input type="checkbox"/>	???	28.	<input type="checkbox"/>	???
13.	<input type="checkbox"/>	???	29.	<input type="checkbox"/>	???
14.	<input type="checkbox"/>	???	30.	<input type="checkbox"/>	???
15.	<input type="checkbox"/>	???	31.	<input type="checkbox"/>	???
16.	<input type="checkbox"/>	???	32.	<input type="checkbox"/>	???

<< [1-32](#) | [33-64](#) | [65-96](#) | [97-128](#) | [129-160](#) | [161-192](#) | [193-224](#) | [225-256](#) | [257-288](#) | [289-320](#) | [321-352](#) | [353-384](#) | [385-416](#) | [417-448](#) | [449-480](#) | [481-500](#) >> [Next](#) >>

Available settings are explained as follows:

Item	Description
Set to Factory Default	Click it to clear all indexes.
Index	Click the index number of the profile the view or edit its settings.
Enable	Check to enable the profile.
Name	User-entered name that identifies the profile.

The following setup screen is shown after a profile index has been clicked.

VPN and Remote Access >> IPsec Peer Identity

Profile Index : 1

Enable this account

Profile Name

Accept Any Peer ID

Accept Subject Alternative Name

Type

IP

Accept Subject Name

Country (C)

State (ST)

Location (L)

Organization (O)

Organization Unit (OU)

Common Name (CN)

Email (E)

Available settings are explained as follows:

Item	Description
Enable this account	Check to enable such account profile.
Profile Name	A name that allows you to identify this profile. The maximum length of the name you can set is 32 characters.
Accept Any Peer ID	When this option is selected, the router accepts any subject alternative name or subject name as valid, regardless of the type and value.
Accept Subject Alternative Name	When this option is selected, the router accepts the type and value of the specified subject alternative name as valid authentication. Supported subject alternative types are IP Address, Domain Name and E-Mail.
Accept Subject Name	When this option is selected, the router performs peer authentication by matching the values of the different subject name fields. These fields include Country (C), State (ST), Location (L), Organization (O), Organization Unit (OU), Common Name (CN), and Email (E).

To save changes on the page, select **OK**; to discard changes, select **Cancel**; to clear settings on this page and revert to default settings, select **Clear**.

III-1-6 VPN Matcher Setup

Normally, to establish VPN connection, at least one peer must have a public IP address. The VPN Matcher server can help two Draytek routers behind NAT establish a secure VPN tunnel for data transmission between each other. Refer to the following figure.

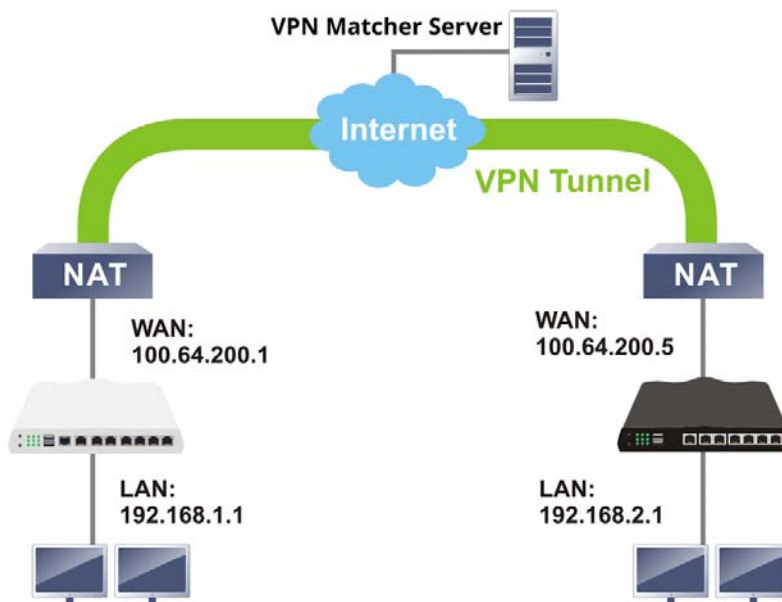

There is one limitation for the VPN connection. Both routers must be behind a cone NAT, but not symmetric NAT.

Go to **VPN and Remote Access >> VPN Matcher Setup** to open the following page.

VPN and Remote Access >> VPN Matcher Setup

Enable Disable

VPN Matcher Server: :

Router List Key:

Note: You can get your Router List Key on [VPN Matcher Dashboard](#).

NAT Detection

STUN Server

Group Device List

Available settings are explained as follows:

Item	Description
Enable / Disable	Click to enable / disable the function of VPN Matcher Setup.
VPN Matcher Server	The IP address of the DrayTek VPN Matcher server is defined as "vpn-matcher.draytek.com" with the port number "31503".
Router List Key	Enter the authentication key for finding a Vigor router with the same group of this device from the VPN matcher server. Then set a VPN link between Vigor routers on both ends via

	VPN wizard.
OK	Click to save the settings.
STUN Server	Detect - Click to check if the NAT used by Vigor router is core NAT or not. If not, no VPN can be established.
Group Device List	Get List - After entering the Authkey above, click to get available Vigor router which is within the same group as this device.

III-1-7 OpenVPN

The OpenVPN protocol utilizes public keys, certificates, and usernames and passwords to authenticate the client. Traffic is carried over secure channels built upon industry-standard SSL/TLS encryption protocols.

With integrating of OpenVPN, Vigor router can help users to achieve more robust, reliable and secure private connections for business needs.

OpenVPN offers a convenient way for users to build a VPN between the local end and the remote end. There are two advantages of OpenVPN:

- It can be operated on different systems such as Windows, Linux, and MacOS.
- Based on the standard protocol of SSL encryption, OpenVPN can provide you with a scalable client/server mode, permitting multi-client to connect to a single OpenVPN Server process over a single TCP or UDP port.

In terms of credentials, the administrator can choose to let the router generate the certificates, or import certificates issued by third-party certificate authorities (CAs). When the router generates the certificates, it acts as the root CA to issue the trusted CA certificates (stored under Certificate Management >> Trusted CA Certificate), which are used to generate the server and client certificates used by OpenVPN (stored under Certificate Management >> Local Certificate). If, however, a certificate issued by a third-party CA is used, both the CA's certificate and the issued certificate need to be imported to the router in the Trusted CA Certificate and Local Certificate sections, respectively.

III-1-7-1 OpenVPN Server Setup

OpenVPN requires the use of certificates. Before establishing OpenVPN connection, general settings for OpenVPN service shall be configured first.



OpenVPN Server Setup	Client Config	Import Certificate
General Setup		
UDP	<input checked="" type="checkbox"/>	Enable
UDP Port	<input type="text" value="1194"/>	
TCP	<input checked="" type="checkbox"/>	Enable
TCP Port	<input type="text" value="1194"/>	
Cipher Algorithm	<input type="text" value="AES256"/>	
HMAC Algorithm	<input type="text" value="SHA256"/>	
Certificate Authentication	<input checked="" type="checkbox"/>	
Certificates Setup		
Certificate Source	<input type="radio"/> Router generated certificates <input checked="" type="radio"/> Uploading certificates to Router	
<u>Trust CA</u>	<input type="text" value="default"/>	
<u>Server Certificate</u>	<input type="text" value="none"/>	

Note: OpenVPN on Vigor Router only support TUN device interface currently. So please setup corresponding configurations on the client side.

OK

Available settings are explained as follows:

Item	Description
General Setup	
UDP	Enable - Select checkbox to enable UDP protocol for OpenVPN connections. UDP Port - Enter the UDP port number.
TCP	Enable - Select checkbox to enable TCP protocol for OpenVPN connections. TCP Port - Enter the TCP port number.
Cipher Algorithm	Select the desired cipher algorithm. Two encryption algorithms are supported: AES128 and AES256. AES256 is more secure than AES128 but may result in lower performance because it incurs higher computational overhead.
HMAC Algorithm	HMAC stands for Hash-based Message Authentication Code. It is used to validate the data integrity and authenticity of the VPN data. Select the desired HMAC hash algorithm. Two hash algorithms, SHA1 and SHA256, are supported. SHA256 is preferred as it is more robust and reliable than SHA1.
Certificate Authentication	Select this checkbox if you would like to validate that the client certificate was issued by a trusted CA.
Certificate Setup	
Certificate Source	Select a source for the certificate to be used for OpenVPN.

	<p>Router generated certificates - Router-generated certificates that will be used for OpenVPN.</p> <ul style="list-style-type: none">● Generate - Click to generate a certificate.● Delete all certificates - Click to remove all certificates generated by the router. <p>Uploading certificates to Router - Third-party certificates will be used for OpenVPN.</p> <ul style="list-style-type: none">● Trust CA - Use the dropdown list to select a trusted CA certificate that has already been uploaded to the router. To upload Trusted CA certificates to the router, click the Trust CA label and you will be taken to the Certificate Management >> Trusted CA Certificate page to perform the operation.● Server Certificate - Use the dropdown list to select a server certificate that has already been uploaded to the router. To upload server certificates to the router, click the Server Certificate label and you will be taken to the Certificate Management >> Local Certificate page to perform the operation.
--	---

After finishing all the settings here, please click **OK** to save the configuration.

III-1-7-2 Client Config

On this page, you can create and export the configuration required for a remote OpenVPN client to connect to the router.

VPN and Remote Access >> OpenVPN



OpenVPN Server Setup	Client Config	Import Certificate
Remote Server	<input checked="" type="radio"/> IP <input type="radio"/> Domain <input type="radio"/> VPN Matcher	<input type="text" value="WAN3 111.251.237.17"/>
Transport Protocol	<input type="text" value="UDP"/>	
Auto Dial-Out	<input checked="" type="radio"/> Enable <input type="radio"/> Disable	
Set VPN as Default Gateway	<input type="radio"/> Enable <input checked="" type="radio"/> Disable	
UDP Ping	<input type="text" value="10"/>	Seconds(s)
UDP Ping exit	<input type="text" value="60"/>	Seconds(s)
File Name	<input type="text"/> .ovpn	
Client cert	<input type="text"/> .cert	
Client key	<input type="text"/> .key	
Mail Profile	<input type="text" value="1 - ???"/>	<input type="text" value="Mail Address"/>
		<input type="button" value="Send Email"/>

Note:

1. Please make sure the Client cert and the Client key are located in the same folder with .ovpn file.
2. Please make sure that WAN can be used as OpenVPN server.

Available settings are explained as follows:

Item	Description
Remote Server	<p>The OpenVPN client will use the IP address or domain name to connect to the router. Select either IP or Domain.</p> <p>IP - The OpenVPN configuration file will use the numeric IP address as the server address.</p> <p>Domain - The OpenVPN configuration file will use the domain as the server address. You need to ensure that the domain resolves to the IP address of a router WAN port.</p> <p>VPN Matcher - The OpenVPN configuration file will use the IP address / URL of VPN matcher server as the remote server.</p>
Transport Protocol	<p>Select UDP or TCP for the protocol to be used by the OpenVPN client to connect to the router.</p>
Auto Dial-Out	<p>Enable - If selected, the remote client can auto-dial to this Vigor router to build an OpenVPN tunnel.</p> <p>Disable - Select to disable the function.</p>
Set VPN as Default Gateway	<p>Enable - If selected, the Vigor router will be treated as a "default" gateway for OpenVPN clients. The OpenVPN client will redirect all the traffic to the Vigor router via the</p>

	<p>OpenVPN tunnel.</p> <p>Disable - Select to disable the function.</p>
UDP Ping	<p>Ping remote device over the UDP control channel, if no packets have been sent for the number of seconds configured here.</p>
UDP Ping exit	<p>Let OpenVPN exit after the seconds set here if no reception of a ping or other packet from the remote device.</p>
File Name	<p>Enter the filename of the configuration file to be downloaded from the router.</p>
Client cert	<p>Enter the filename of the client certificate obtained from 3rd party provider.</p>
Client key	<p>Enter the filename of the private key obtained from the 3rd party provider.</p>
Mail Profile	<p>The system administrator can send an email containing the OpenVPN client configuration to someone who needs it. Later, the recipient can use the configuration to connect to the company's Intranet. It is useful and convenient for Smart VPN Client user or employee on a business trip.</p> <p>Mail Address - Enter the IP address of the recipient.</p> <p>Send Email - After clicking this button, the recipient will receive an email with the content of OpenVPN client configuration.</p>
Export	<p>Click this button to download the settings on this page as a file, which can be imported into a VPN client to establish OpenVPN connections.</p>

III-1-7-3 Import Certificate

On this page, you can import the certificate from other places for a remote OpenVPN client to connect to the router.

VPN and Remote Access >> OpenVPN



OpenVPN Server Setup **Client Config** **Import Certificate**

Import OpenVPN config file
Note:
1. TLS-auth key won't be deleted even you load the .rst firmware.
2. Please clear the LAN-to-LAN Profile if you want to delete the TLS-auth key.

Select a OpenVPN config file.

未選擇任何檔案

Click [Import](#) to upload the certificate.

Import X509 Local / Trusted CA Certificate
Note:
1. Please setup the "System Maintenance >> [Time and Date](#)" correctly before signing the local/trusted CA certificate.
2. The Time Zone MUST be setup correctly!!

Available settings are explained as follows:

Item	Description
Select a OpenVPN config file	Browse - Click to select a file. Import - Click to import a configuration file.
Import Local Certificate	Click to access into Local Certificate page for importing a certificate.
Import Trusted CA Certificate	Click to access into Trusted CA Certificate page for importing a certificate.

III-1-8 WireGuard

WireGuard, at present, is a secure, fast, easy, simple and modern open-source VPN Protocol. By using state-of-the-art cryptography, WireGuard can build a VPN simply by exchanging private and public keys between VPN servers (e.g., Vigor router) and VPN clients (e.g., SmartVPN Client).

VPN and Remote Access >> WireGuard

Server Private Key	<input type="text"/>	<input type="button" value="Generate a Key Pair"/>
Server Public Key	<input type="text"/>	<input type="button" value="Copy to Clipboard"/>
		
WireGuard Interface IP	<input type="text" value="192.168.1.1"/>	
Server Listen port	<input type="text" value="51820"/>	
<input type="button" value="OK"/>		

Available settings are explained as follows:

Item	Description
Server Private Key	Displays the private key generated. Generate a Key Pair - Generate keys for the VPN server.
Server Public Key	It is required to be configured in the WireGuard VPN client router. After clicking Generate a Key Pair , the public key and a QR code representing the public key will be shown on this page. Copy to Clipboard - Click to save the keys as a text file.
WireGuard Interface IP	Enter an IP address. Vigor router's LAN IP can be used as the WireGuard interface IP.
Server Listen Port	Enter a port number for WireGuard VPN server. The default number is 51820.

To save changes on the page, select **OK**; to discard changes, select **Cancel**.

III-1-9 Remote Dial-in User

You can manage remote access by maintaining a table of remote user profiles, so that users can be authenticated via VPN connection. Remote dial-in user profiles can be set up on this screen.

VPN and Remote Access >> Remote Dial-in User



Remote Access User Accounts: [Set to Factory Default](#)

View: All Online Offline

Index	Enable	User	Status	Index	Enable	User	Status
1.	<input type="checkbox"/>	???	---	17.	<input type="checkbox"/>	???	---
2.	<input type="checkbox"/>	???	---	18.	<input type="checkbox"/>	???	---
3.	<input type="checkbox"/>	???	---	19.	<input type="checkbox"/>	???	---
4.	<input type="checkbox"/>	???	---	20.	<input type="checkbox"/>	???	---
5.	<input type="checkbox"/>	???	---	21.	<input type="checkbox"/>	???	---
6.	<input type="checkbox"/>	???	---	22.	<input type="checkbox"/>	???	---
7.	<input type="checkbox"/>	???	---	23.	<input type="checkbox"/>	???	---
8.	<input type="checkbox"/>	???	---	24.	<input type="checkbox"/>	???	---
9.	<input type="checkbox"/>	???	---	25.	<input type="checkbox"/>	???	---
10.	<input type="checkbox"/>	???	---	26.	<input type="checkbox"/>	???	---
11.	<input type="checkbox"/>	???	---	27.	<input type="checkbox"/>	???	---
12.	<input type="checkbox"/>	???	---	28.	<input type="checkbox"/>	???	---
13.	<input type="checkbox"/>	???	---	29.	<input type="checkbox"/>	???	---
14.	<input type="checkbox"/>	???	---	30.	<input type="checkbox"/>	???	---
15.	<input type="checkbox"/>	???	---	31.	<input type="checkbox"/>	???	---
16.	<input type="checkbox"/>	???	---	32.	<input type="checkbox"/>	???	---

<< [1-32](#) | [33-64](#) | [65-96](#) | [97-128](#) | [129-160](#) | [161-192](#) | [193-224](#) | [225-256](#) | [257-288](#) | [289-320](#) | [321-352](#) | [353-384](#) | [385-416](#) | [417-448](#) | [449-480](#) | [481-500](#) >> [Next](#) >>

Enable VPN Remote Dail In from LAN

Isolate VPN Users from each other

Backup setting to file:

Restore From File:

Available settings are explained as follows:

Item	Description
Set to Factory Default	Click to clear all remote-dial-in user profiles.
View	All - Click it to display the all of the user accounts. Online - Click it to display the online user accounts. Offline - Click it to display the offline user accounts.
Index	Click the index number of the profile the view or edit its settings.
Enable	Check to enable the user profile.
User	Display the username for the specific dial-in user of the LAN-to-LAN profile. The symbol ??? represents that the

	profile is empty.
Status	Shows the LAN subnet and IP address assignment method. Example: LAN1-DHCP means that the IP address of the VPN connection will be drawn from the DHCP pool of the LAN1 subnet. The color of the status indicates the current state of the profile: Green - Profile is being used by a dial-in VPN connection. Red - Profile is not being used. Black - Profile is disabled.
Enable VPN Remote Dial In from LAN	It offers greater security for LAN client. A client (especially untrusted LAN device) must establish a secure VPN connection via Vigor router with IKEv2 EAP, IPsec Xauth, SSL or WireGuard first. Then the client can access a private LAN for getting the required resources by checking this option.
Isolate VPN Users from each other	Although the VPN users can access a private LAN via the Vigor router, they (remote dial-in user accounts) cannot communicate with each other if this option is selected.
Backup	Click Backup to save the configuration.
Restore	Click Select to choose a configuration file. Then click Restore to apply the file.

To save changes on the page, select **OK**; to discard changes, select **Cancel**.

The following setup screen is shown after a profile index has been clicked.

Index No. 1

Enable this Account
 Multiple Concurrent Connections Allowed
 Idle Timeout second(s)

Allowed Dial-In Type

PPTP
 IPsec Tunnel
 IKEv1/IKEv2 IKEv2 EAP IPsec XAuth
 L2TP with IPsec Policy
 SSL Tunnel
 OpenVPN Tunnel
 WireGuard

Specify Remote Node
 Remote Client IP Domain Name

 or Peer ID
 Netbios Naming Packet Pass Block
 Multicast via VPN Pass Block
 (for some IGMP,IP-Camera,DHCP Relay..etc.)

Subnet

 Assign Static IP Address

Two-Factor Authentication

Send Authentication Code via Email
 Send Authentication Code via SMS
 Time-based One-time Password (TOTP)
 Secret

User Account and Authentication

Username
 Password
 Enable Mobile One-Time Passwords(mOTP)
 Enable Time-based One-time Password(TOTP)

IKE Authentication Method

Pre-Shared Key

 Digital Signature(X.509)

IPsec Security Method

Medium(AH)
 High(ESP) DES 3DES AES
 Local ID (optional)

WireGuard Peer Setting

Public key
 Pre-shared key
 Persistent keepalive second(s)

Schedule Profile
 , , ,

Notification

Send Email when VPN is up
Email Object
 Mail to
 Send SMS when VPN is up
SMS Object
 SMS to

Note:

1. Username can not contain characters ' ' and \ .
2. When you are trying to use OpenVPN tunnel and the router is behind NAT, you may have to enable the **VPN-Matcher** feature to bypass the NAT.
3. VPN-Matcher can only be used behind Cone NAT.
4. WireGuard VPN Protocol doesn't support passing Netbios or Multicast packets.

Available settings are explained as follows:

Item	Description
User account and Authentication	<p>Enable this account - Select to enable this profile to be used by remote dial-in users.</p> <p>Multiple Concurrent Connections Allowed - If enabled, multiple VPN clients can connect the VPN server with the username/password set on this profile.</p> <p>Idle Timeout - Allowed idle time before the router disconnects the VPN connection. Default timeout value is 300 seconds.</p>
Allowed Dial-In Type	<p>Select all VPN protocols allowed for this profile.</p> <p>For L2TP, specify how IPsec should be applied. Options are:</p> <ul style="list-style-type: none"> • None - IPsec cannot be used with L2TP connections. • Nice to Have - IPsec is preferred but not mandatory for L2TP connections. • Must - IPsec is required when establish L2TP connections. <p>Specify Remote Node - The IP address of the remote VPN client (Remote Client IP) or the Peer ID (used in IKE aggressive mode) can be optionally specified. The router will reject the connection if either of these values are entered in the profile but the remote client does not pass the value, or</p>

	<p>passes the wrong value.</p> <p>Netbios Naming Packet - Specifies whether to allow NetBIOS naming packets to traverse through the VPN tunnel.</p> <ul style="list-style-type: none"> ● Pass - Click it to have an inquiry for data transmission between the hosts located on both sides of VPN Tunnel while connecting. ● Block - When there is conflict occurred between the hosts on both sides of VPN Tunnel in connecting, such function can block data transmission of Netbios Naming Packet inside the tunnel. <p>Multicast via VPN - Specifies whether to allow multicast packets to traverse through the VPN tunnel.</p> <ul style="list-style-type: none"> ● Pass - Click this button to let multicast packets pass through the router. ● Block - This is default setting. Click this button to let multicast packets be blocked by the router.
<p>Subnet</p>	<p>The VPN client will receive an IP address from the DHCP pool or IP address range specified in IP Address Assignment for Dial-In Users for the selected LAN subnet.</p> <p>Assign Static IP Address - Alternatively, a static IP address can be set by selecting the Assign Static IP Address checkbox.</p>
<p>Two-Factor Authentication</p>	<p>When a remote dal-in user tries to log in Vigor router from the VPN, he/she has to pass the two-factor authentication.</p> <p>Send Authentication Code via Email - Select to send the authentication code via an e-mail. The e-mail address can be specified in the field of Mail to under the Notification area.</p> <div data-bbox="715 1144 1136 1346" style="border: 1px solid #ccc; padding: 5px;"> <p>Notification</p> <p><input checked="" type="checkbox"/> Send Email when VPN is up</p> <p>Email Object 1 - ??? ▾</p> <p>Mail to <input style="border: 2px solid red;" type="text"/></p> <p><input type="checkbox"/> Send SMS when VPN is up</p> </div> <p>Send Authentication Code via SMS - Select to send the authentication code via an SMS. The telephone number can be specified in the field of SMS to under the Notification area.</p> <div data-bbox="715 1507 1136 1776" style="border: 1px solid #ccc; padding: 5px;"> <p>Notification</p> <p><input checked="" type="checkbox"/> Send Email when VPN is up</p> <p>Email Object 1 - ??? ▾</p> <p>Mail to <input type="text"/></p> <p><input checked="" type="checkbox"/> Send SMS when VPN is up</p> <p>SMS Object 1 - ??? ▾</p> <p>SMS to <input style="border: 2px solid red;" type="text"/></p> </div> <p>Time-based One-time Password (TOTP) - Select to display a secret generated by Vigor router.</p> <p>Regenerate - Click to regenerate a new secret and corresponding QR code.</p> <p>Reset - Click to clear the secret.</p> <p>Secret - Displays a 32 digit-secret number generated by Vigor router. Corresponding code also will be shown in this area.</p>

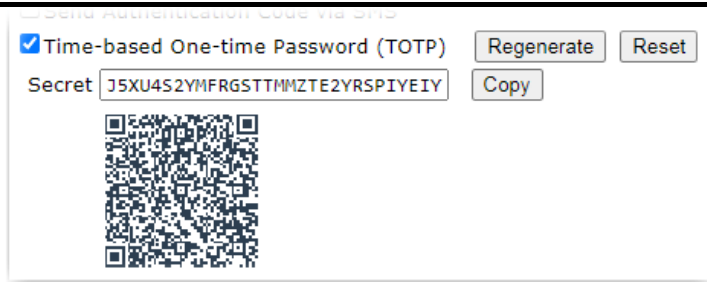

Copy - Click to copy the secret.

User Account and Authentication

User Name - Used for PPTP, L2TP or SSL Tunnel dial-in type. The length of the name is limited to 23 characters.

Password - Used for PPTP, L2TP or SSL Tunnel dial-in type. The length of the password is limited to 19 characters.

Enable Mobile One-Time Passwords (mOTP) - Select to enable one-time passwords (Mobile-OTP). Enter the PIN Code and Secret. DrayTek's SmartVPN client has built-in support for mOTP. Third-party mOTP clients can be used to generate passwords when using other VPN clients. For more information on mOTP, visit Mobile-OTP's homepage.

- **PIN Code** - Enter the code for authentication (e.g, 1234).
- **Secret** - Use the 32 digit-secret number generated by mOTP in the mobile phone (e.g., e759bb6f0e94c7ab4fe6).

Enable Time-based One-time Password (TOTP) - Please make sure the time zone of your router is correct. Then, install Google Authenticator APP on your cell phone. Open the APP to scan the QR code on this page. A one-time password will be shown on your phone.

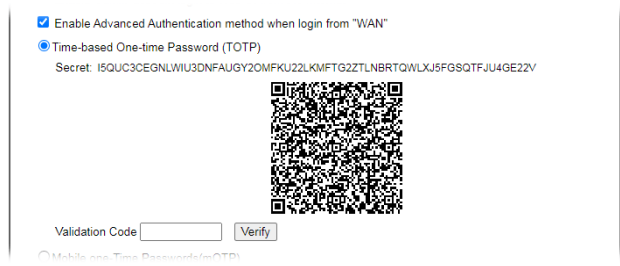

In the field of **Validation Code**, enter the one-time password and click **Verify**.

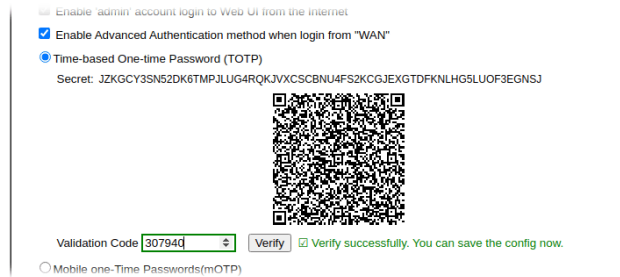

Now, the configuration is finished. You will be asked to enter the 2FA code on the after passing the username and password authentication.

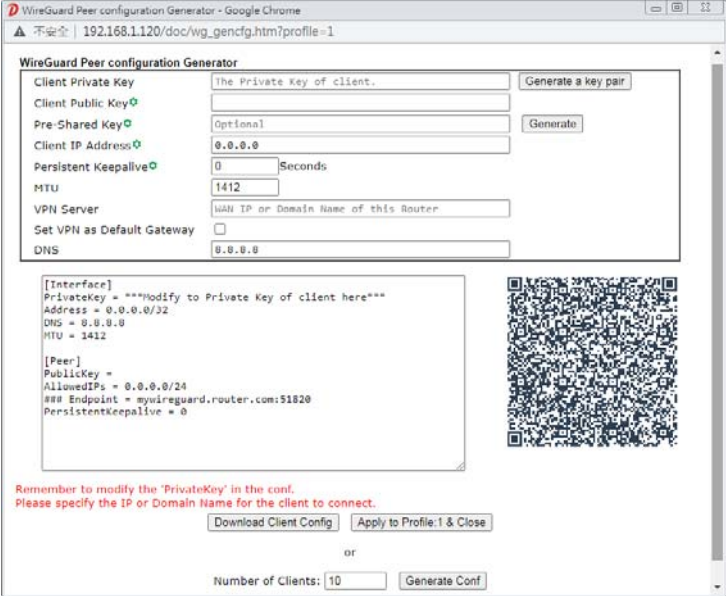
	
IKE Authentication Method	<p>Pre-Shared Key - This checkbox is available when Remote Client IP or Peer ID is specified. Check the checkbox and click IKE Pre-shared Key to enter an IKE PSK (1~63 characters) that will be used only for this profile.</p> <p>Digital Signature (X.509) - To enable authentication using X.509 Peer IDs, check the checkbox then select an X.509 profile. X.509 profiles can be configured in VPN and Remote Access >> IPsec Peer Identity.</p>
IPsec Security Method	<p>Select all the IPsec protocols that are allowed to be used for this profile.</p> <p>Medium-Authentication Header (AH) means data will be authenticated, but not be encrypted. By default, this option is invoked. You can uncheck it to disable it.</p> <p>High (ESP) - High-Encapsulating Security Payload (ESP) means payload (data) will be encrypted and authenticated. You may select encryption algorithm from Data Encryption Standard (DES), Triple DES (3DES), and AES.</p> <p>Local ID (Optional)- Specify a local ID to be used when establishing a LAN-to-LAN VPN connection using IKE aggressive mode.</p>
WireGuard Peer Setting	<p>Configure the settings for VPN client (peer).</p> <p>Client Config Generator - Click to pop-up the configuration window.</p>  <p>A QR code will be generated according to the settings configured in this pop-up window. Then, download the x.conf file by clicking Download Client Config and Apply to Profiles & Close.</p> <p>Public Key - Displays the value generated by clicking Client Config Generator.</p> <p>Pre-shared Key - Displays the value generated by clicking</p>

	<p>Client Config Generator.</p> <p>Persistent Keepalive - Default is 60 seconds. If the peer is behind a NAT or a firewall, use the default setting.</p>
Schedule Profile	<p>Set the VPN connection to work at certain time interval only. You may choose up to 4 schedules out of the 15 schedules pre-defined in Applications >> Schedule setup. The default setting of this field is blank and the function will always work.</p>
Notification	<p>Send Email when VPN is up - An e-mail will be sent to the user defined in Email Object when VPN is connected and up.</p> <ul style="list-style-type: none"> ● Mail to - Enter an email address. <p>Send SMS when VPN is up - An SMS will be sent to the user defined in SMS Object when VPN is connected and up.</p> <ul style="list-style-type: none"> ● SMS to - Enter a phone number.

To save changes on the page, select **OK**; to discard changes, select **Cancel**; to clear settings on this page and revert to default settings, select **Clear**.

III-1-10 LAN to LAN

This section allows you to configure up to 500 LAN-to-LAN VPN connection profiles. LAN-to-LAN connections can be configured to allow dial-in only, dial-out only, or both dial-in and dial-out.

The following figure shows the summary table according to the item (All/Trunk) selected for View.

VPN and Remote Access >> LAN to LAN ?

LAN-to-LAN Profiles: | [Set to Factory Default](#) |

View: All Online Offline Trunk [] Search

Index	Enable	Name	Remote Network	Status	Index	Enable	Name	Remote Network	Status
1	<input type="checkbox"/>	???		---	17	<input type="checkbox"/>	???		---
2	<input type="checkbox"/>	???		---	18	<input type="checkbox"/>	???		---
3	<input type="checkbox"/>	???		---	19	<input type="checkbox"/>	???		---
4	<input type="checkbox"/>	???		---	20	<input type="checkbox"/>	???		---
5	<input type="checkbox"/>	???		---	21	<input type="checkbox"/>	???		---
6	<input type="checkbox"/>	???		---	22	<input type="checkbox"/>	???		---
7	<input type="checkbox"/>	???		---	23	<input type="checkbox"/>	???		---
8	<input type="checkbox"/>	???		---	24	<input type="checkbox"/>	???		---
9	<input type="checkbox"/>	???		---	25	<input type="checkbox"/>	???		---
10	<input type="checkbox"/>	???		---	26	<input type="checkbox"/>	???		---
11	<input type="checkbox"/>	???		---	27	<input type="checkbox"/>	???		---
12	<input type="checkbox"/>	???		---	28	<input type="checkbox"/>	???		---
13	<input type="checkbox"/>	???		---	29	<input type="checkbox"/>	???		---
14	<input type="checkbox"/>	???		---	30	<input type="checkbox"/>	???		---
15	<input type="checkbox"/>	???		---	31	<input type="checkbox"/>	???		---
16	<input type="checkbox"/>	???		---	32	<input type="checkbox"/>	???		---

<< [1-32](#) | [33-64](#) | [65-96](#) | [97-128](#) | [129-160](#) | [161-192](#) | [193-224](#) | [225-256](#) | [257-288](#) | [289-320](#) | [321-352](#) | [353-384](#) | [385-416](#) | [417-448](#) | [449-480](#) | [481-500](#) >> Next >>

Change default route to None ▼

Pass packets from LAN in Routing mode to VPN

Pass Packets to WAN when VPN disconnects

OK Cancel

Backup setting to file:

Backup

Upload From File: 選擇檔案 未選擇任何檔案

Restore

Note:
 1. Only 1 Lan-to-Lan profile can select "Default Route".
 [XXXXXX:This Dial-out profile has already joined for VPN Load Balance Mechanism]
 [XXXXXX:This Dial-out profile has already joined for VPN Backup Mechanism]
 [XXXXXX:This Dial-out profile does not join for VPN TRUNK]

Available settings are explained as follows:

Item	Description
Set to Factory Default	Click to clear all indexes.

View	All - Shows all LAN-to-LAN VPN profiles. Trunk - Shows all Trunk profiles (see VPN and Remote Access >> VPN TRUNK Management).
Index	Click the index number of the profile to view or edit its settings.
Enable	Check to enable the LAN-to-LAN VPN profile.
Name	Display the name of the LAN-to-LAN profile. The symbol ??? represents that the profile is empty.
Remote Network	Display the name of the remote network.
Status	Shows the status of the profile. Online - LAN-to-LAN VPN is connected. Offline - LAN-to-LAN VPN is disconnected. --- - Profile is disabled.
Change default route to	Select a profile as the default route.
Pass packets from LAN in Routing mode to VPN	If enabled, the packets from routing LAN will pass through the VPN tunnel.
Pass Packets to WAN when VPN disconnects	If enabled, the packets can pass through via NAT when the VPN disconnects.
Backup	Click Backup to save the configuration.
Restore	Click Select to choose a configuration file. Then click Restore to apply the file.

The following figure shows profiles joined into VPN Load Balance and VPN Backup mechanism.

VPN and Remote Access >> LAN to LAN

LAN-to-LAN Profiles:

View: All Online Offline Trunk

Name	Activate	Members	Status
Loadbala1	v	Cathy Jack	Offline Offline

[XXXXXX:This Dial-out profile has already joined for VPN Load Balance Mechanism]
[XXXXXX:This Dial-out profile has already joined for VPN Backup Mechanism]

If there is no profile joined yet, this page will be shown as follows:

VPN and Remote Access >> LAN to LAN

LAN-to-LAN Profiles:

View: All Online Offline Trunk

Name	Activate	Members	Status

[XXXXXX:This Dial-out profile has already joined for VPN Load Balance Mechanism]
[XXXXXX:This Dial-out profile has already joined for VPN Backup Mechanism]

To edit each profile, click each index to edit each profile.

- The setup screen is shown after a profile index has been clicked. There are 6 sections: Common Settings, Dial-Out Settings, Dial-In Settings, Tunnel Settings, 6in4 Settings and TCP/IP Network Settings.

VPN and Remote Access >> LAN to LAN

Profile Index : 1

Common Settings

<input type="checkbox"/> Enable this profile Profile Name <input type="text" value="???"/>	Always on <input type="checkbox"/> Enable Idle Timeout <input type="text" value="300"/> second(s) Quality Monitoring/Keep Alive <input type="checkbox"/> Enable
Call Direction <input checked="" type="radio"/> Both <input type="radio"/> Dial-Out <input type="radio"/> Dial-In <input type="radio"/> GRE Tunnel	Netbios Naming Packet <input checked="" type="radio"/> Pass <input type="radio"/> Block Multicast via VPN <input type="radio"/> Pass <input checked="" type="radio"/> Block <small>(for some IGMP,IP-Camera,DHCP Relay..etc.)</small>
Dial-Out Through <input type="text" value="WAN1 First"/>	

Dial-Out Settings

VPN Server <input checked="" type="radio"/> PPTP <input type="radio"/> IPsec Tunnel <input type="text" value="IKEv1"/> <input type="radio"/> L2TP with IPsec Policy <input type="text" value="Must"/> <input type="radio"/> SSL Tunnel <input type="radio"/> OpenVPN Tunnel <input type="text" value="TCP"/> <input type="radio"/> WireGuard	Username <input type="text" value="???"/> Password <input type="text" value="Max: 128 characters"/>
Server IP/Host Name <input type="text" value="Max: 128 characters"/>	PPP Advanced Settings
Dial-Out Schedule Profile <input type="text" value="None"/> , <input type="text" value="None"/> , <input type="text" value="None"/> , <input type="text" value="None"/>	

Dial-In Settings

Allowed VPN Type <input type="checkbox"/> PPTP <input checked="" type="checkbox"/> IPsec Tunnel(IKEv1/IKEv2) <input checked="" type="checkbox"/> IPsec XAuth <input checked="" type="checkbox"/> L2TP with IPsec Policy <input type="text" value="Must"/> <input checked="" type="checkbox"/> SSL Tunnel <input checked="" type="checkbox"/> OpenVPN Tunnel <input type="text" value="UDP/TCP"/> <input type="checkbox"/> WireGuard	Username <input type="text" value="???"/> Password <input type="text" value="Max: 128 characters"/>
<input type="checkbox"/> Specify Remote VPN Gateway <input checked="" type="radio"/> Remote IP <input type="radio"/> Remote Domain Name Peer ID <input type="text" value="Max: 128 characters"/> Local ID <input type="text" value="Max: 47 characters"/>	PPP Advanced Settings OpenVPN Advanced Settings Allowed IKE Authentication Method <input checked="" type="checkbox"/> Pre-Shared Key <input type="text" value="Max: 128 characters"/> <input type="checkbox"/> X.509 Digital Signature <input type="text" value="None"/> Preferred Local ID <input type="text" value="Alternative Subject Name"/>
	Allowed IPsec Security Method <input checked="" type="checkbox"/> AH <input checked="" type="checkbox"/> ESP-DES <input checked="" type="checkbox"/> ESP-3DES <input checked="" type="checkbox"/> ESP-AES

Tunnel Settings

<input type="checkbox"/> Enable IPsec Dial-Out function GRE over IPsec Tunnel Local IP <input type="text"/>	<input type="checkbox"/> Logical Traffic Tunnel Remote IP <input type="text"/>
--	---

TCP/IP Network Settings

Local Network IP <input type="text" value="192.168.13.1"/> / Mask <input type="text" value="255.255.255.0 / 24"/>	Mode <input checked="" type="radio"/> Routing <input type="radio"/> NAT RIP via VPN <input type="text" value="Disable"/>
Remote Network IP <input type="text" value="0.0.0.0"/> / Mask <input type="text" value="255.255.255.0 / 24"/>	Translate Local Network <input type="checkbox"/> Enable
More Remote Subnet <input type="text"/>	<input type="checkbox"/> Change Default Route to this VPN tunnel <small>(This only works if there is only one WAN online)</small>

Available settings are explained as follows:

Item	Description
Common Settings	
Common Settings	Enable this profile - Check here to activate this profile. Profile Name - Specify a name for the profile of the LAN-to-LAN connection. Call Direction - Specify the allowed call direction of this LAN-to-LAN profile. Four choices are available for connection

	<p>mode:</p> <ul style="list-style-type: none"> ● Both - Profile is to be used to initiate (dial out) or accept (dial in) connections. ● Dial-Out - Profile is to be used to initiate outgoing connections. ● Dial-In - Profile is to be used to accept incoming connections. ● GRE Tunnel - Connection is by means of a GRE tunnel. <p>Dial-Out Through - Use the drop down menu to choose a proper WAN interface for this profile. This setting is useful for dial-out only.</p> <ul style="list-style-type: none"> ● WANx First- While connecting, the router will use WANx as the first channel for VPN connection. If WANx fails, the router will use another WAN interface instead. ● WANx Only - While connecting, the router will use WANx as the only channel for VPN connection. ● WAN1 Only: Only establish VPN if WAN2 down - If WAN2 failed, the router will use WAN1 for VPN connection. ● WAN2 Only: Only establish VPN if WAN1 down - If WAN1 failed, the router will use WAN2 for VPN connection. <p>Always On - Select this option to maintain an always on dial-out connection.</p> <p>Idle Timeout - The router will close connection if no activity is observed in the VPN connection for this many seconds. Default value is 300 seconds.</p> <p>Quality Monitoring/Keep Alive - Select this option to keep the VPN connection for the feature of SD-WAN quality monitoring.</p> <p>Netbios Naming Packet - Specifies whether to allow NetBIOS naming packets to traverse through the VPN tunnel.</p> <ul style="list-style-type: none"> ● Pass - click it to have an inquiry for data transmission between the hosts located on both sides of VPN Tunnel while connecting. ● Block - When there is conflict occurred between the hosts on both sides of VPN Tunnel in connecting, such function can block data transmission of Netbios Naming Packet inside the tunnel. <p>Multicast via VPN - Specifies whether to allow multicast packets to traverse through the VPN tunnel.</p> <ul style="list-style-type: none"> ● Pass - Click this button to let multicast packets pass through the router. ● Block - This is default setting. Click this button to let multicast packets be blocked by the router.
--	--



Dial-Out Settings	
VPN Server	Select the VPN protocol to be used.
Server IP/Host Name	IP address or DNS host name of remote VPN host.
Dial-Out Schedule Profile	Connect and disconnect according to schedule profiles. The default setting of this field is blank and the function will always work.
User Name	Enter a username for establishing VPN connection.

Password	Enter the password for establishing VPN connection.
If PPTP / L2TP with IPsec Policy / SSL Tunnel / is selected as VPN Server	<p>PPP Advanced Settings - Click it to expand the advanced settings for PPP.</p> <ul style="list-style-type: none"> ● PPP Authentication - PAP Only - Authenticate dial-in users using the PAP protocol only. PAP/CHAP/MS-CHAP/MS-CHAPv2 - Attempt to authenticate dial-in users using various CHAP protocols, and if the remote VPN client fails to authenticate, fall back to PAP. ● VJ compression - Specifies whether to enable Van Jacobson (VJ) header compression, which improves throughput on slow connections. ● Request IP Address - Enter the IP address.
If IPsec/ L2TP with IPsec Policy (Must/Nice to Have) is selected as VPN Server	<p>IKE Phase 1 Settings - Select from Main mode and Aggressive mode. The ultimate outcome is to exchange security proposals to create a protected secure channel. Main mode is more secure than Aggressive mode since more exchanges are done in a secure channel to set up the IPsec session. However, the Aggressive mode is faster. The default value in Vigor router is Main mode.</p> <ul style="list-style-type: none"> ● Authentication - Digital Signature(X.509) <ul style="list-style-type: none"> - Peer ID - Select one of the predefined Profiles set in VPN and Remote Access >>IPsec Peer Identity. - Local ID - Use Alternative Subject Name or Subject Name of local certificate as local ID. - Local Certificate - Select one of the profiles set in Certificate Management>>Local Certificate. ● Authentication - Pre-Shared Key <ul style="list-style-type: none"> - Pre-Shared Key - Input 1-128 characters as pre-shared key. - Local ID - Enter local IKE identity to send in the exchange to establish IPsec connection. ● proposal Encryption - Use Auto/AES/3DES/DES for packet encryption. ● proposal ECDH Group - Specify a group if Auto is not selected as proposal Encryption. ● proposal Authentication - Select SHA256 or SHA1 for packet authentication. ● Force UDP Encapsulation - Select to make UDP encapsulation forcefully. All IPsec packets will be encapsulated with UDP header. <p>IKE Phase 2 Settings - Specify the security protocol, proposal encryption and proposal authentication.</p> <ul style="list-style-type: none"> ● Security Protocol - AH (Medium) means data will be authenticated, but not be encrypted. By default, this option is active. ESP (High) means payload (data) will be encrypted and authenticated. ● Proposal Encryption - Use AES/3DES encryption algorithm and apply MD5 or SHA-1 authentication algorithm. ● Proposal Authentication - Select All, SHA or None. <p>IKE Advanced Settings - Specify the key life of each IKE phase, network ID, etc.</p> <ul style="list-style-type: none"> ● IKE phase 1 key lifetime- For security reason, the

	<p>lifetime of key should be defined. The default value is 28800 seconds. You may specify a value in between 900 and 86400 seconds.</p> <ul style="list-style-type: none"> ● IKE phase 2 key lifetime- For security reason, the lifetime of key should be defined. The default value is 3600 seconds. You may specify a value in between 600 and 86400 seconds. ● Phase 2 Network ID - This is optional. Change the source IP address of VPN traffic to the specified IP address for NAT mode selected on TCP/IP Network Settings field. ● Enable Perfect Forward Secret (PFS) - The IKE Phase 1 key will be reused to avoid the computation complexity in phase 2. The default value is inactive this function. <p>Ping to Keep Alive - Select to enable the function of PING to keep alive.</p> <p>PING Target IP - Enter the IP address to keep alive.</p>
<p>If OpenVPN Tunnel is selected as VPN Server</p>	<p>OpenVPN Advanced Settings - Click to set the advanced settings for OpenVPN.</p> <ul style="list-style-type: none"> ● Cipher Algorithm - Select an algorithm for encrypting the packets via OpenVPN. ● HMAC Algorithm - Select an algorithm for authenticating the packets via OpenVPN. ● Client Certificate - Select a client certificate or self-signed a new certificate or DrayDDNS certificate. ● Trust CA - Select a trust CA certificate. ● Compress - Select a method to compress the packets to reduce the bandwidth usage while transferring the compressed packets. ● TLS - auth - Select On to use the TLS authentication method. Related key information can be checked by clicking View. <p>Import OpenVPN config file - An OpenVPN config file from other Vigor router can be imported and apply to this router.</p> <ul style="list-style-type: none"> ● Select File - Select a file from your hard disk. ● Import - Click to upload the selected config file to this Vigor router.
<p>If WireGuard with is selected as VPN Server</p>	<p>Click WireGuard to set the advanced settings.</p> <p>[Interface] - Configure the settings for Vigor router.</p> <ul style="list-style-type: none"> ● Generate a Key Pair - Click to generate a key pair (including private key and public key). ● Copy to Clipboard - Click to copy the key pair to clipboard. ● Address - Enter an IP address of the peer. <p>[Peer] - Configure the settings for the client (peer).</p> <ul style="list-style-type: none"> ● Public Key - Enter the key generated above. ● Generate - Click to generate the pre-shared key. ● Keepalive - Default is 60 seconds.
<p>Dial-In Settings</p>	
<p>Allowed VPN Type</p>	<p>Select permissible VPN protocols for dial-in connections.</p> <ul style="list-style-type: none"> ● PPTP - Allow the remote dial-in user to make a PPTP VPN connection through the Internet. You should set

	<p>the User Name and Password of remote dial-in user below.</p> <ul style="list-style-type: none"> ● IPsec Tunnel(IKEv1/IKEv2)- Allow the remote dial-in user to trigger an IPsec VPN connection through Internet. ● IPsec XAuth ● L2TP with IPsec Policy - Allow the remote dial-in user to make a L2TP VPN connection through the Internet. You can select to use L2TP alone or with IPsec. Select from below: <ul style="list-style-type: none"> - None - Do not apply the IPsec policy. Accordingly, the VPN connection employed the L2TP without IPsec policy can be viewed as one pure L2TP connection. - Nice to Have - Apply the IPsec policy first, if it is applicable during negotiation. Otherwise, the dial-in VPN connection becomes one pure L2TP connection. - Must - Specify the IPsec policy to be definitely applied on the L2TP connection. ● SSL Tunnel- Allow the remote dial-in user to trigger an SSL VPN connection through Internet. ● OpenVPN Tunnel ● WireGuard - A pop-up window with detailed settings will be shown on the screen. Enter the values if required.
<p>Specify Remote VPN Gateway</p>	<p>You can specify the IP address of the remote dial-in user or peer ID (should be the same with the ID setting in dial-in type) by checking the box. Also, you should further specify the corresponding security methods on the right side.</p> <p>If you uncheck the checkbox, the connection type you select above will apply the authentication methods and security methods in the general settings.</p> <p>Username - This field is applicable when you select PPTP or L2TP with or without IPsec policy above. The length of the name is limited to 11 characters.</p> <p>Password - This field is applicable when you select PPTP or L2TP with or without IPsec policy above. The length of the password is limited to 11 characters.</p>
<p>PPP Advanced Settings</p>	<p>Click it to expand the advanced settings for PPP.</p> <p>VJ Compression - Specifies whether to enable Van Jacobson header compression, which improves throughput on slow connections.</p> <p>Assign Peer IP Address - Enter the IP address of the peer.</p>
<p>OpenVPN Advanced Settings</p>	<p>Cipher Algorithm - Select an algorithm for encrypting the packets via OpenVPN.</p> <p>HMAC Algorithm - Select an algorithm for authenticating the packets via OpenVPN.</p>
<p>Allowed IKE Authentication Method</p>	<p>This section is available when IPsec tunnel is selected as the dial-out protocol. Available options are IKE Pre-shared key and X.509 digital signature.</p> <p>Pre-Shared Key - To use a pre-shared key, select this radio-button and then click the IKE Pre-Shared Key button to enter the PSK.</p>

	<p>X.509 Digital Signature - To use an X.509 digital signature, select this radio button and then select an X.509 IPsec Peer Identity profile. To enable authentication using X.509 Peer IDs. X.509 profiles can be configured in VPN and Remote Access >> IPsec Peer Identity.</p> <ul style="list-style-type: none"> ● Local ID - Select whether to first match Subject Alternative Name or Subject Name during authentication. <ul style="list-style-type: none"> - Alternative Subject Name - The alternative subject name (configured in Certificate Management>>Local Certificate) will be inspected first. - Subject Name - The subject name (configured in Certificate Management>>Local Certificate) will be inspected first.
Allowed IPsec Security Method	<p>This setting is available when IPsec Tunnel is selected as the dial-out protocol.</p> <ul style="list-style-type: none"> ● AH- Authentication Header (AH) means data will be authenticated, but not be encrypted. Select to use Authentication Header protocol. By default, this option is active. ● ESP-DES/ESP-3DES/ESP-AES - Encapsulating Security Payload (ESP) means payload (data) will be encrypted and authenticated. You may select encryption algorithm from Data Encryption Standard (DES), Triple DES (3DES), and AES.
Tunnel Settings	
Enable IPsec Dial-Out function GRE over IPsec	<p>Check this box to verify data and transmit data in encryption with GRE over IPsec packet after configuring IPsec Dial-Out setting. Both ends must match for each other by setting same virtual IP address for communication.</p>
Logical Traffic	<p>Such technique comes from RFC2890. Define logical traffic for data transmission between both sides of VPN tunnel by using the characteristic of GRE. Even hacker can decipher IPsec encryption, he/she still cannot ask LAN site to do data transmission with any information. Such function can ensure the data transmitted on VPN tunnel is really sent out from both sides. This is an optional function. However, if one side wants to use it, the peer must enable it, too.</p>
Tunnel Local IP	<p>Enter the virtual IP for router itself for verified by peer.</p>
Tunnel Remote IP	<p>Enter the virtual IP of peer host for verified by router.</p>
TCP/IP Network Settings	
Local Network	<p>The default value is 0.0.0.0, which means the Vigor router will get a PPP IP address from the remote router during the IPCP negotiation phase. If the PPP IP address is fixed by remote side, specify the fixed IP address here. Do not change the default value if you do not select PPTP or L2TP.</p> <p>IP / Mask - Display the local network IP and mask for TCP / IP configuration. You can modify the settings if required.</p>
Remote Network	<p>The default value is 0.0.0.0, which means the Vigor router will get a remote Gateway PPP IP address from the remote</p>

	<p>router during the IPCP negotiation phase. If the PPP IP address is fixed by remote side, specify the fixed IP address here. Do not change the default value if you do not select PPTP or L2TP.</p> <p>IP/ Mask - Add a static route to direct all traffic destined to this Remote Network IP Address/Remote Network Mask through the VPN connection. For IPsec, this is the destination clients IDs of phase 2 quick mode.</p>
<p>More Remote Subnet</p>	<p>Click to bring up a dialog box to enter additional static routes for subnets destined for the remote network.</p> <p>More Remote Subnet </p> <div data-bbox="707 573 1422 853" style="border: 1px solid black; padding: 5px;"> <p><input type="checkbox"/> Create a unique SA for each subnet(IPsec)</p> <p>Network IP <input type="text"/></p> <p>Subnet Mask <input type="text" value="255.255.255.255 / 32"/></p> <p><input type="button" value="Add"/> <input type="button" value="Delete"/> <input type="button" value="Edit"/></p> <p>More Remote Subnet <input type="text"/></p> </div>
<p>Mode</p>	<p>If the remote network only allows one IP address for the local network, select NAT; otherwise, select Routing.</p>
<p>When the Mode is set to Routing</p>	<p>When Routing is selected, the available fields in the TCP/IP Network Settings section will be shown as:</p> <p>Translate Local Network - Check the box to enable the function. Add a static route to direct all traffic destined to more Remote Network IP Addresses/ Remote Network Mask through the VPN connection. This is usually used when you find there are several subnets behind the remote VPN router.</p> <ul style="list-style-type: none"> ● Type - There are two types (Translate Whole Subnet, Translate Specific IP) for you to choose. <p>When Translate Whole Subnet is selected as Type, available settings are listed as below:</p> <div data-bbox="770 1328 1342 1458" style="border: 1px solid black; padding: 5px;"> <p>Type <input type="text" value="Translate Whole Subnet"/></p> <p>Local Subnet <input type="text" value="LAN1"/></p> <p>Translated IP <input type="text" value="192.168.1.0"/></p> <p>More Local Subnet </p> </div> <div data-bbox="770 1464 1409 1686" style="border: 1px solid black; padding: 5px;"> <p>Local Network <input type="text" value="LAN1"/></p> <p>Translated to <input type="text" value="0.0.0.0"/></p> <p><input type="button" value="Add"/> <input type="button" value="Delete"/> <input type="button" value="Edit"/></p> </div> <ul style="list-style-type: none"> - Local Subnet - Select the LAN whose IP addresses are to be translated. - Translated IP - Specify an IP address. - More Local Subnet - Click it to add more subnets. <p>When Translate Specific IP is selected as Type, available settings are listed as below:</p>

	<p>Type Translate Specific IP ▼</p> <div style="border: 1px solid black; padding: 5px;"> <p>Virtual IP Mapping</p> <div style="border: 1px solid gray; height: 80px; margin-bottom: 5px;"></div> <p>Local IP <input style="width: 100px;" type="text"/> Virtual IP <input style="width: 100px;" type="text"/></p> <p style="text-align: center;"> <input type="button" value="Add"/> <input type="button" value="Delete"/> <input type="button" value="Edit"/> </p> </div> <p>- Virtual IP Mapping - A pop up dialog will appear for you to specify the local IP address and the mapping virtual IP address.</p>
<p>When the Mode is set to NAT</p>	<p>When NAT is selected, the available fields in the TCP/IP Network Settings section will be shown as:</p> <p>RIP via VPN - Specifies the direction of Routing Information Protocol (RIP) packets. Available options are:</p> <ul style="list-style-type: none"> ● TX/RX Both - can transmit or receive RIP packets ● TX Only - can only transmit but not receive RIP packets ● RX Only - can only receive but not transmit RIP packets ● Disable - RIP is disabled. <p>Change Default Route to this VPN tunnel - Select this option to direct all traffic that is not LAN-bound to this VPN tunnel. This option is functional when there is only one active WAN.</p>

2. To save changes on the LAN to LAN profile page, select **OK**; to reset the entire page to blank, select **Clear**; to discard changes, select **Cancel**.

III-1-11 VPN Trunk Management

A VPN Trunk combines TWO LAN-to-LAN VPN tunnels to provide VPN Backup or VPN Load Balance functionalities.

VPN Backup

VPN Backup provides redundant, uninterrupted VPN connectivity by constantly monitoring the health of a VPN tunnel, and fails over to the secondary VPN tunnel when the primary tunnel fails.

In a Backup VPN Trunk, only one of the two LAN-to-LAN VPN tunnels is connected at any given time. When one tunnel fails, the router will automatically start up and direct all VPN traffic destined for the trunk to the other tunnel.

VPN Load Balance

VPN Load Balance increases the bandwidth of a LAN-to-LAN connection by combining and load balancing two tunnels, with the option to direct traffic to specific tunnels by originating address, destination address or port.

In a Load Balance VPN Trunk, both LAN-to-LAN VPN tunnels are simultaneously connected. The router first attempts to match the traffic to a load balance policy rule and send it down the tunnel specified in the matching rule. Traffic not matched to any policy will be load balanced in a round-robin fashion, and the traffic ratio between the two tunnels is either determined automatically by the router or specified by the user.

In order to set up a VPN Trunk, 2 LAN-to-LAN VPN profiles must have been configured first. For details on the configuration of LAN-to-LAN VPN tunnels, see section V-1-10 LAN to LAN. When the 2 LAN-to-LAN VPN profiles are ready, follow the steps below to set up a VPN Trunk.

Creating a VPN Trunk

To create a new VPN Trunk, configure the General Setup section first.



Backup Profile List | [Set to Factory Default](#) |

Note:
 [Active:NO] The LAN-to-LAN Profile is disabled or under Dial-In(Call Direction) at present.

No.	Status	Name	Member1 (Active) Type	Member2 (Active) Type

Advanced

Load Balance Profile List | [Set to Factory Default](#) |

Note:
 [Active:NO] The LAN-to-LAN Profile is disabled or under Dial-In(Call Direction) at present.

No.	Status	Name	Member1 (Active) Type	Member2 (Active) Type

Advanced

General Setup

Status Enable Disable

Profile Name

Member1

Member2

Active Mode Backup Load Balance

Available settings are explained as follows:

Item	Description
General Setup	<p>Status - Enable or disable the VPN Trunk.</p> <ul style="list-style-type: none"> ● Enable - Select this to enable this VPN trunk. ● Disable - Select this to disable this VPN trunk. <p>Profile Name - Enter a name to identify this VPN Trunk profile.</p> <p>Member 1/Member2 - Select LAN-to-LAN VPN profiles to be the first and second members of this VPN Trunk.</p> <p>Active Mode - Select the operation mode of the VPN Trunk.</p> <p>Backup / Load Balance - Select this to set up a Backup / Load Balance VPN Trunk.</p> <p>Add - Select it to add a VPN Trunk Profile using the entered information.</p> <p>Update - Select it to save the changes to the Status (Enable or Disable), profile name, member1 or member2.</p> <p>Delete - Select it to delete the selected VPN TRUNK profile. The corresponding members (LAN-to-LAN profiles) grouped in the deleted VPN TRUNK profile will be released and that profiles in LAN-to-LAN will be displayed in black.</p>

Configuring, Modifying or Deleting a VPN Trunk

To configure or modify a VPN Trunk, go to the Profile List section that corresponds to the type of the VPN trunk (Backup or Load Balance).

VPN and Remote Access >> VPN TRUNK Management



Backup Profile List | [Set to Factory Default](#) |

Note:

[Active:NO] The LAN-to-LAN Profile is disabled or under Dial-In(Call Direction) at present.

No.	Status	Name	Member1 (Active) Type	Member2 (Active) Type

Advanced

Load Balance Profile List | [Set to Factory Default](#) |

Note:

[Active:NO] The LAN-to-LAN Profile is disabled or under Dial-In(Call Direction) at present.

No.	Status	Name	Member1 (Active) Type	Member2 (Active) Type

Advanced

General Setup

Status Enable Disable

Profile Name

Member1

Member2

Active Mode Backup Load Balance

Add Update Delete

Available settings are explained as follows:

Item	Description
Backup Profile List and Load Balance Profile List	<p>Set to Factory Default - Removes all VPN Trunk profiles in the Profile List.</p> <p>No. - The index number of VPN profile.</p> <p>Status - Shows whether the VPN Trunk is enabled or disabled.</p> <ul style="list-style-type: none"> ● v - VPN Trunk is enabled. ● x - VPN Trunk is disabled. <p>Name - The user-entered name that identifies the trunk profile.</p> <p>Member1 (Active) Type / Member2 (Active) Type - Shows the profile index, whether it is enabled or disabled, and the VPN protocol of the 2 LAN-to-LAN VPN profiles.</p> <p>Example: 1(YES)PPTP - the trunk member is set to use the first profile which is currently enabled and uses the PPTP protocol.</p> <p>Advanced - To configure advanced settings of a VPN Trunk</p>

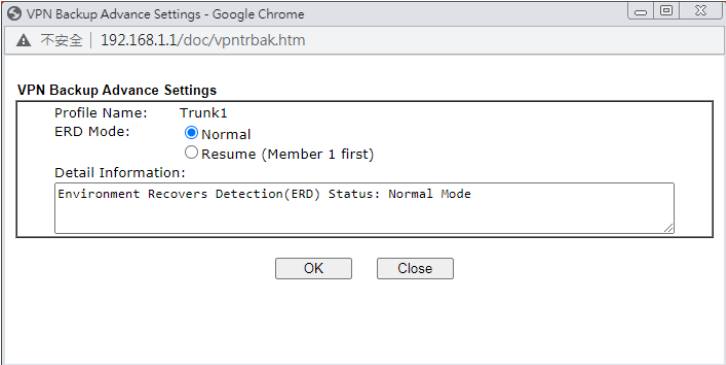
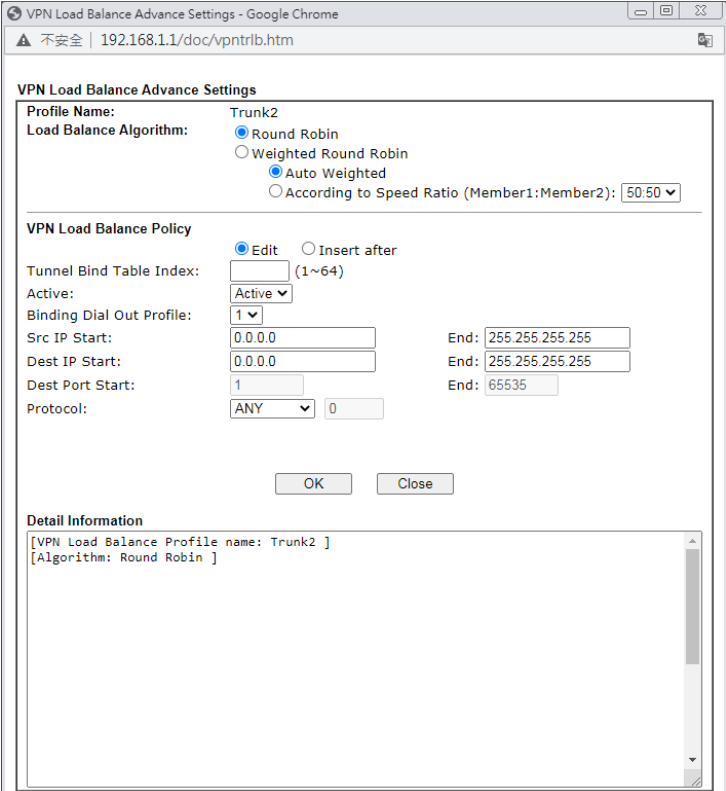
	<p>profile, select its name from the dropdown list and click Advanced.</p>
<p>Advanced for Backup Profile List</p>	<p>If a Backup Profile was selected, the following Advanced Settings screen appears:</p>  <p>Profile Name - User-defined name that identifies this profile.</p> <p>ERD Mode - Sets the Environment Recovery Detection (ERD) mode.</p> <ul style="list-style-type: none"> ● Normal - Both VPN tunnels have equivalent priority. ● Resume - Member 1 and Member 2 VPN tunnels are primary and secondary connections, respectively. The router will always attempt to use Member 1 first, and only fail over to Member 2 if Member 1 is down. <p>Detail Information - Provides a detailed explanation of the ERD mode.</p> <p>To save Advanced Settings for the profile, select OK; to close without saving changes, select Close.</p>
<p>Advanced for Load Balance Profile List</p>	<p>If a Load Balance Profile was selected, the following Advanced Settings screen appears:</p>  <p>Profile Name - User-defined name that identifies this</p>

	<p>profile.</p> <p>Load Balance Algorithm - Configures how load balancing is performed.</p> <ul style="list-style-type: none"> ● Round Robin - All outgoing connections that do not match to any load balance policy are evenly distributed between the tunnels. ● Weighted Round Robin -- All outgoing connections that do not match to any load balance policy are distributed between the tunnels based on a ratio that is either automatically determined by the router (Auto Weighted), or specified by the user (According to Speed Ratio). <p>VPN Load Balance Policy - This section allows the modification or addition of load balance policy profiles.</p> <p>Edit / Insert After - Select Edit to modify the existing load balance profile with index specified in Tunnel Bind Table Index, or Insert After to insert a new load balance profile immediately after the index position specified in Tunnel Bind Table Index.</p> <p>Tunnel Bind Table Index- 64 Binding tunnel tables are provided by this device. In Edit mode, the profile that matches this index will be updated.</p> <p>In Insert After mode, a new profile will be inserted immediately after the policy having this index.</p> <p>Active - Includes Active and Clear. In which,</p> <ul style="list-style-type: none"> ● Active - All information will be saved into a load balance profile. ● Clear - The profile with index matching Tunnel Bind Table Index will be deleted. <p>Binding Dial Out Profile - The LAN-to-LAN VPN tunnel to which traffic matching this policy will be sent.</p> <p>Scr IP Start /End- Specify source IP addresses as starting point and ending point.</p> <p>Dest IP Start/End - Specify the target IP addresses as starting point and ending point.</p> <p>Dest Port Start /End- Specify the target port range if the protocol is TCP or UDP.</p> <p>Protocol - Specify the protocol of the traffic.</p> <p>Detail Information - Shows all the information about the Load Balance profile.</p> <p>To save Advanced Settings for the profile, select OK; to close without saving changes, select Close.</p>
Add	Select it to add a VPN Trunk Profile using the entered information.
Update	<p>Make modifications as necessary in the General Setup section.</p> <p>Select it to save the changes to the Status (Enable or Disable), profile name, member1 or member2.</p>
Delete	<p>Select it to remove the VPN TRUNK profile.</p> <p>The corresponding members (LAN-to-LAN profiles) grouped in the deleted VPN TRUNK profile will be released and that profiles in LAN-to-LAN will be displayed in black.</p>

III-1-12 Connection Management

You can find the summary table of all VPN connections. You may disconnect any VPN connection by clicking **Drop** button. You may also aggressively Dial-out by using Dial-out Tool and clicking **Dial** button.

VPN and Remote Access >> Connection Management

Dial-out Tool Refresh

General Mode:	(2962) 172.16.2.3	Dial
Backup Mode:		Dial
Load Balance Mode:		Dial

VPN Connection Status

All VPN Status		LAN-to-LAN VPN Status		Remote Dial-in User Status				
VPN	Type	Remote IP	Virtual Network	Tx Pkts	Tx Rate(bps)	Rx Pkts	Rx Rate(bps)	UpTime
<input type="checkbox"/> No subpagging <input type="checkbox"/> No auto refreshing								

xxxxxxxx : Data is encrypted.
 xxxxxxxx : Data isn't encrypted.

Available settings are explained as follows:

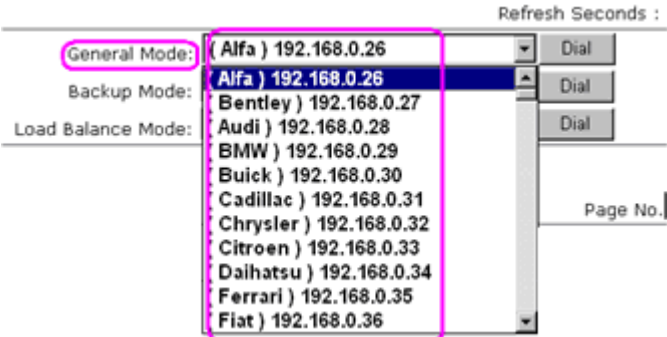
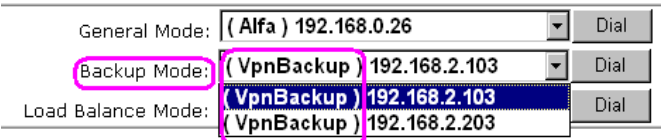
Item	Description
Refresh	Click to manually reload the page to refresh VPN connection information.
Dial-out Tool	<p>The Dial-out Tool section can be used to initiate outgoing LAN-to-LAN VPN sessions.</p> <p>General Mode - It lists all LAN-to-LAN VPN profiles that do not belong to enabled VPN Trunk profiles.</p> <p>To manually dial a LAN-to-LAN VPN profile, select it from the combo box, and click the Dial button to the right. The VPN connection built by General Mode does not support VPN backup function.</p>  <p>Backup Mode - It lists all Backup VPN Trunk profiles. To manually dial a Backup VPN Trunk profile, select it from the combo box, and click the Dial button to the right. The VPN connection built by Backup Mode supports VPN backup function.</p>  <p>Load Balance Mode - It lists all Load Balance VPN Trunk profiles. To manually dial a Load Balance VPN Trunk profile, select it from the combo box, and click the Dial button to the</p>

	<p>right.</p> <p>Dial - Click this button to execute dial out function. If the connect is successfully made, it will show up in the VPN Connection Status section below.</p>
VPN Connection Status	<p>VPN - Displays the VPN profile number and the profile name.</p> <p>Type - Displays the VPN protocol used for the connection</p> <p>Remote IP - Displays the remote IP address of the VPN connection.</p> <p>Virtual Network - Displays the IP subnet used by the VPN connection.</p> <p>Tx Pkts - Displays the number of packets that have been transmitted through the VPN connection.</p> <p>Tx Rate(Bps) - Displays the current upstream speed of the VPN connection.</p> <p>Rx Pkts - Displays the number of packets that have been received through the VPN connection.</p> <p>Rx Rate(Bps) - Displays the current downstream speed of the VPN connection.</p> <p>UpTime - Displays the elapsed time of the VPN connection.</p> <p>Drop - Click this button to disconnect this VPN connection.</p>

III-2 Certificate Management

A digital certificate is an electronic document issued by a certification authority (CA) to an entity to prove ownership of a public key. It contains identifying information including the issued-to party's name, a serial number, expiration dates etc., and the digital signature of the certificate-issuing authority so that a recipient can verify that the certificate is real. Vigor router supports digital certificates that conform to the X.509 standard.

In this section, you can generate and manage local digital certificates, and import trusted CA certificates. Be sure that the system time is correct on the router so that certificates will not be erroneously considered to be invalid because of an incorrect system time falling outside of the certificate's valid time period. The easiest way to accomplish this is by periodically synchronizing the system time to a Network Time Protocol (NTP) server.

Web User Interface

VPN and Remote Access
Certificate Management
Local Certificate
Trusted CA Certificate
Certificate Backup
Self-Signed Certificate
Wireless LAN

III-2-1 Local Certificate

You can generate, import or view local certificates on this page.

Certificate Management >> Local Certificate

X509 Local Certificate Configuration

Name	Subject	Status	Modify	
DrayDDNS (Global)	/CN=faeallen3910.drayddns.com	● OK	View	Delete
---	---	---	View	Delete
---	---	---	View	Delete

Note:

1. Please setup the "System Maintenance >> **Time and Date**" correctly before signing the local/trusted CA certificate.
2. The Time Zone MUST be setup correctly!!

Available settings are explained as follows:

Item	Description
Name	Displays the Name that identifies the certificate.
Subject	Displays the Subject Name entries of the certificate.
Status	Displays the status of the certificate. Status is one of Requesting.
Modify	View - Click to view details about the certificate. A screen that looks like the following will be displayed, showing the Subject Name, Subject Alternative Name, and the certificate content.

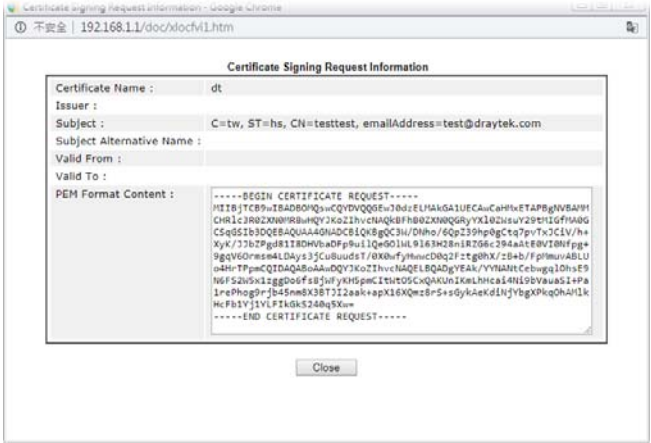
	 <p>Delete - Click to remove the certificate.</p>
Generate	Click to fill out details about a certificate, and start the generation process.
Import	Click to update an existing certificate.
Refresh	Click to refresh the page to display the latest certificate information.

GENERATE

Use this screen to submit a request to your root CA to generate a certificate.

Certificate Management >> Local Certificate

Generate Certificate Signing Request

Certificate Name	<input type="text"/>
Subject Alternative Name	
Type	IP Address <input type="button" value="v"/>
IP	<input type="text"/>
Subject Name	
Country (C)	<input type="text"/>
State (ST)	<input type="text"/>
Location (L)	<input type="text"/>
Organization (O)	<input type="text"/>
Organization Unit (OU)	<input type="text"/>
Common Name (CN)	<input type="text"/>
Email (E)	<input type="text"/>
Key Type	RSA <input type="button" value="v"/>
Key Size	2048 Bit <input type="button" value="v"/>
Algorithm	SHA-256 <input type="button" value="v"/>

Available settings are explained as follows:

Item	Description
Certificate Name	Name that identifies the certificate.
Type	Select the type of Subject Alternative Name and enter its value.

Country (C)	Country in which your organization is located.
State (ST)	State or province where your organization is located.
Location (L)	City where you're your organization is located.
Organization (O)	Legal name of your organization.
Organization Unit (OU)	Department within your organization that you wish to be associated with this certificate.
Common Name (CN)	Fully-qualified domain name / WAN IP that will be used to reach your server.
Email (E)	Email address of the entry.
Key Type	Key type is hard set to RSA.
Key Size	Choose between 1024 and 2048 bit.
Algorithm	Choose between SHA-1 and SHA-256.
Generate	Click to submit generate request to the CA server.



Info

Please be noted that "Common Name" must be configured with rotuer's WAN IP or domain name.

After clicking the **Generate** button, you will be taken back to the main Local Certificate screen, showing the certificate request in progress:

Certificate Management >> Local Certificate

X509 Local Certificate Configuration

Name	Subject	Status	Modify	
server	/C=TW/ST=Hsinchu/L=Hsinchu/O...	Requesting	View	Delete
---	---	---	View	Delete
---	---	---	View	Delete

[GENERATE](#) [IMPORT](#) [REFRESH](#)

IMPORT

Vigor router allows you to generate a certificate request and submit it the CA server, then import it as "Local Certificate". If you have already gotten a certificate from a third party, you may import it directly. The supported types are PKCS12 Certificate and Certificate with a private key.

Click this button to import a saved file as the certification information. There are three types of local certificate supported by Vigor router.

Import X509 Local Certificate

Upload Local Certificate
 Select a local certificate file.
 Certificate file:
 Click **Import** to upload the local certificate.

Upload PKCS12 Certificate
 Select a PKCS12 file.
 PKCS12 file:
 Password:
 Click **Import** to upload the PKCS12 file.

Upload Certificate and Private Key
 Select a certificate file and a matchable Private Key.
 Certificate file:
 Key file:
 Password:
 Click **Import** to upload the local certificate and private key.

Available settings are explained as follows:

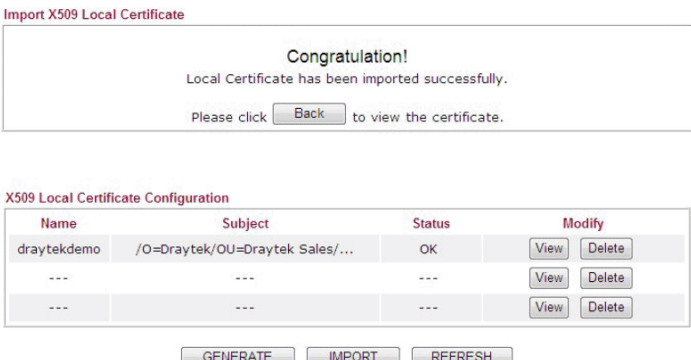
Item	Description																
Upload Local Certificate	<p>Certificate file - Click Browse to select a local certificate file. Import - Click to import selected certificate file to router. Cancel - Click to return to the main Local Certificate screen. If you have done well in certificate generation, the Status of the certificate will be shown as "OK".</p>  <p>The screenshot shows a 'Congratulation!' message: 'Local Certificate has been imported successfully. Please click Back to view the certificate.' Below it is the 'X509 Local Certificate Configuration' table:</p> <table border="1"> <thead> <tr> <th>Name</th> <th>Subject</th> <th>Status</th> <th>Modify</th> </tr> </thead> <tbody> <tr> <td>draytekdemo</td> <td>/O=Draytek/OU=Draytek Sales/...</td> <td>OK</td> <td><input type="button" value="View"/> <input type="button" value="Delete"/></td> </tr> <tr> <td>---</td> <td>---</td> <td>---</td> <td><input type="button" value="View"/> <input type="button" value="Delete"/></td> </tr> <tr> <td>---</td> <td>---</td> <td>---</td> <td><input type="button" value="View"/> <input type="button" value="Delete"/></td> </tr> </tbody> </table> <p>Buttons: <input type="button" value="GENERATE"/> <input type="button" value="IMPORT"/> <input type="button" value="REFRESH"/></p>	Name	Subject	Status	Modify	draytekdemo	/O=Draytek/OU=Draytek Sales/...	OK	<input type="button" value="View"/> <input type="button" value="Delete"/>	---	---	---	<input type="button" value="View"/> <input type="button" value="Delete"/>	---	---	---	<input type="button" value="View"/> <input type="button" value="Delete"/>
Name	Subject	Status	Modify														
draytekdemo	/O=Draytek/OU=Draytek Sales/...	OK	<input type="button" value="View"/> <input type="button" value="Delete"/>														
---	---	---	<input type="button" value="View"/> <input type="button" value="Delete"/>														
---	---	---	<input type="button" value="View"/> <input type="button" value="Delete"/>														
Upload PKCS12 Certificate	<p>It allows users to import the certificate whose extensions are usually .pfx or .p12. And these certificates usually need passwords. Note that PKCS12 is a standard for storing private keys and certificates securely. It is used in (among other things) Netscape and Microsoft Internet Explorer with their import and export options. PKCS12 file - Click Browse to select a PKCS12 certificate file. Password - Enter the password associated with the certificate and key files. Import - Click to import selected certificate file to router.</p>																

	Cancel - Click to return to the main Local Certificate screen.
Upload Certificate and Private Key	<p>It is useful when users have separated certificates and private keys. And the password is needed if the private key is encrypted.</p> <p>Certificate file - Click Browse to select a local certificate file.</p> <p>Key file -</p> <p>Password - Enter the password associated with the certificate and key files.</p> <p>Import - Click to import selected certificate file to router.</p> <p>Cancel - Click to return to the main Local Certificate screen.</p>

If the import was successful, you will see the following confirmation screen:

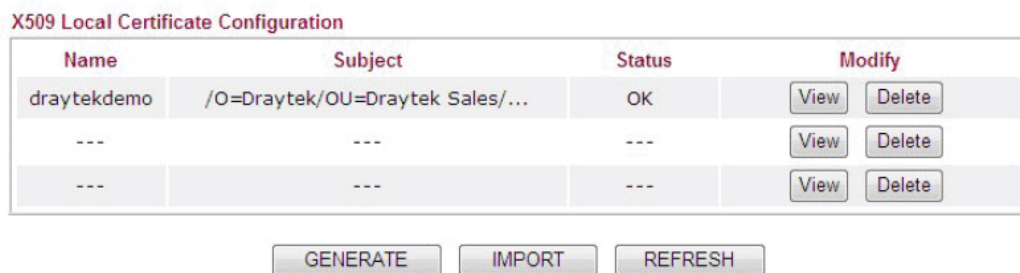
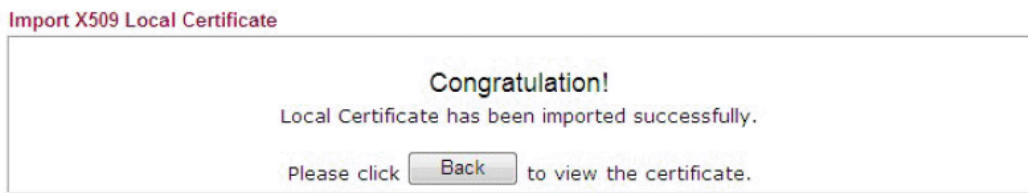

REFRESH

Click this button to refresh the information listed below.

III-2-2 Trusted CA Certificate

Trusted CA certificate lists three sets of trusted CA certificate. In addition, you can build a RootCA certificate if required.

When the local client and remote client are required to make certificate authentication (e.g., IPsec X.509) for data passing through SSL tunnel and avoiding the attack of MITM, a trusted root certificate authority (Root CA) will be used to authenticate the digital certificates offered by both ends.

However, the procedure of applying digital certificate from a trusted root certificate authority is complicated and time-consuming. Therefore, Vigor router offers a mechanism which allows you to generate root CA to save time and provide convenience for general user. Later, such root CA generated by DrayTek server can perform the issuing of local certificate.



Info

Root CA can be deleted but not edited. If you want to modify the settings for a Root CA, please delete the one and create another one by clicking Create Root CA.

You can create, import and view root and trusted certificate authority certificates on this screen.

Certificate Management >> Trusted CA Certificate

X509 Trusted CA Certificate Configuration

Name	Subject	Status	Modify
Root CA	---	---	Create
Trusted CA-1	---	---	View Delete
Trusted CA-2	---	---	View Delete
Trusted CA-3	---	---	View Delete

Note:

1. Please setup the "System Maintenance >> **Time and Date**" correctly before you try to generate a RootCA!!
2. The Time Zone MUST be setup correctly!!

IMPORT

REFRESH

Available settings are explained as follows:

Item	Description
Create	Click to create a new root CA.
Name	Name that identifies the certificate.
Subject	Shows the Subject Name of the certificate.
Status	Displays the status of the certificate.
Modify	Create Root CA - Click to fill out details about a certificate, and start the generation process. View - Click to view details of the certificate.

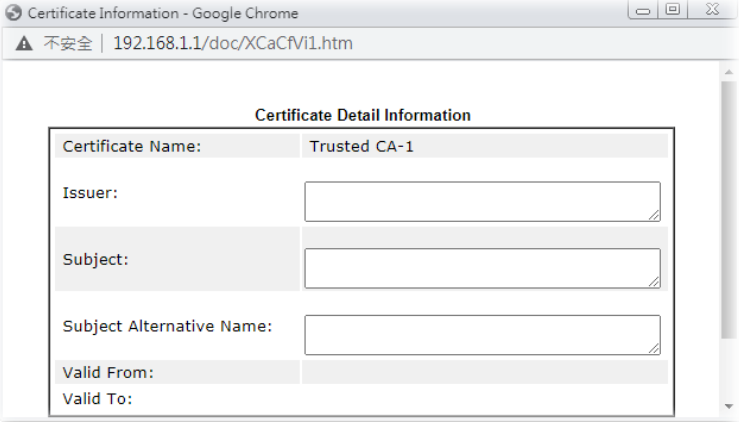
	 <p>Delete - Click to delete the certificate.</p>
Import	Click to import an existing certificate.
Refresh	Click to refresh the page to display the latest certificate information.

Creating a RootCA

Click **Create Root CA** to open the following page.

Certificate Management >> Root CA Certificate

Generate Root CA

Certificate Name	Root CA <input type="button" value="Fill the default value"/>
Subject Alternative Name	
Type	IP Address ▼
IP	<input type="text"/>
Subject Name	
Country (C)	<input type="text"/>
State (ST)	<input type="text"/>
Location (L)	<input type="text"/>
Organization (O)	<input type="text"/>
Organization Unit (OU)	<input type="text"/>
Common Name (CN)	<input type="text"/>
Email (E)	<input type="text"/>
Key Type	RSA ▼
Key Size	1024 Bit ▼
Algorithm	SHA-256 ▼

Available settings are explained as follows:

Item	Description
Certificate Name	Display the name of root CA. Fill the default value - Click to enter the default value for this Root CA.
Type	Select the type of Subject Alternative Name and enter its value.
Country (C)	Country in which your organization is located.
State (ST)	State or province where your organization is located.
Location (L)	City where you're your organization is located.
Organization (O)	Legal name of your organization.
Organization Unit (OU)	Department within your organization that you wish to be associated with this certificate.
Common Name (CN)	Fully-qualified domain name / WAN IP that will be used to reach your server.
Email (E)	Email address of the entry.
Key Type	Key type is hard set to RSA.
Key Size	Choose between 1024 and 2048 bit.
Algorithm	Choose between SHA-1 and SHA-256.
Generate	Click to submit generate request to the CA server.

Importing a Trusted CA

To import a pre-saved trusted CA certificate, please click **IMPORT** to open the following window.

Certificate Management >> Trusted CA Certificate

Import X509 Trusted CA Certificate

Select a trusted CA certificate file.

Click **Import** to upload the certification.

Available settings are explained as follows:

Item	Description
Browse	Click Browse to select a local certificate file.
Import	Click to import selected certificate file to router. The one you imported will be listed on the Trusted CA Certificate window.
Cancel	Click to return to the main Trusted CA Certificate screen.

III-2-3 Certificate Backup

You can back up Local and Trusted CA certificates on the router to a file.

Certificate Management >> Certificate Backup

Certificate Backup / Restoration

Backup

Encrypt password: Max: 23 characters

Confirm password:

Click to download certificates to your local PC as a file.

Restoration

Select a backup file to restore.

未選擇任何檔案

Decrypt password:

Click to upload the file.

Available settings are explained as follows:

Item	Description
Backup	
Encrypt password / Confirm password	Enter the password with which you wish to encrypt the certificate.
Backup	Click to download the certificate.
Restoration	
Select a backup file to restore	Click Browse to select the backup file you wish to restore.

Decrypt password	Enter the password that was used to encrypt the certificates.
Restore	Click to retrieve the certificate.

III-2-4 Self-Signed Certificate

A self-signed certificate is a *unique* identification for the device (e.g., Vigor router) which generates the certificate by itself to ensure the router security. Such self-signed certificate is signed with its own private key.

The self-signed certificate will be applied in SSL VPN, HTTPS, and so on. In addition, it can be created for free by using a wide variety of tools.

Certificate Management >> Self-Signed Certificate

Self-Signed Certificate Information

Certificate Name :	self-signed
Issuer :	C=TW, ST=HsinChu, L=HuKou, O=DrayTek Corp., OU=DrayTek Support, CN=Vigor Router
Subject :	C=TW, ST=HsinChu, L=HuKou, O=DrayTek Corp., OU=DrayTek Support, CN=Vigor Router
Subject Alternative Name :	DNS:www.draytek.com
Valid From :	Jun 15 12:38:44 2022 GMT+02:00
Valid To :	Jul 15 12:38:44 2023 GMT+02:00
PEM Format Content :	<pre> -----BEGIN CERTIFICATE----- MIIDpjCCAo6gAwIBAgIJAN0kz5D0jET4MA0GCSqGSIb3DQEBCwUAMHgxCAJ3BgnV BAYTA1RXMRawDgYDVQQIDAdIc2luQ2h1MQ4wDAYDVQQHDAVidUtvvdTEwMBQGA1UE CgwNRHJheVRlayBDb3JwLjEYMBYGA1UECwwPRHJheVRlayBtdXBw3J0MRUwEwYD VQDDAxwawdvc1B5b3V0ZXIwHhcNMjIwMTAzODQ0wHcNMjIwMTAzODQ0 WjB4MQswCQYDVQQGEwJUVzEQMA4GA1UECAwHSHNpbkNodTEOMAwGA1UEBwwFShVL b3UxZjAUBGNVBAoMDURyYX1UZWsgQ29ycC4xGDAwBGNVBA5MD0RyYX1UZWsgU3Vw cG9ydDEVMBMGA1UEAwMm1nb3IglUm91dGVyMIIIBIjANBgkqhkiG9w0BAQEFAAOc AQ8AMIIBCGKCAQEAtF1wIAC91f9YyjIGGZ01jN8ARXd2VVVIivahK/Y1RUr/fbHb MrH8CwWo5oe0h20qY8+cUPGDmJVOAu7ncQcrePHAj+1QygiRkbOf1h40iMUlw+nZ PMwtW5wBlwLcPOUymuHGgp7fDfnRIDJJ1j6QoSDzfmGNNG5MSCL7zQ195D+E+PZG 071hgyq0or+89YfyhcJ3pVq4nvDMF3bCZsE81usrIUzpx6xSHn0M4mx1w7xjpETx hz3xyAmJSFkVUQ/H00swiNruLuo/k6DR30r1UFQ7NPvJ71N8LT8jwADDxcT1Nmhz /m4KMyoqJ5Y75vLYOAY460TK30j66Sbw1DJKzwIDAQABozMTATBGNVHSEDDAK BgggBggEFBQCDAaBgNVHREEEzARgg93d3cuZHJheXRlay5jb20wDQYJKoZIhvcN AQELBQADggEBAK4ZBy2eVGiCZEWcbbUigx2pyIxGj9L7/TQ/YzfgqWd1jpa1GNux bmnFO/SuUQpQZJdaxrfCk03DJT4S15ghWBAEBRKBmclZq7JXSzUM5Y1GrpfsjxaK dF3Rrjw1z015gGmTbFdnFGniXF8Yq2K1KzyxD7NR3ciZJ1rdJ4hKSXNfy7rMnJvu ftIJKTSQpbF76UJ5TVP95U1XtYT9uT3QNQFJM70h8SQDGMbPv02r1Jq2Hm+EVD waVBKuA3VMUG0bPpkd2INTQGVWar1015FXLtbLaD0u+geb+XxvoIOHCbxaEk3GNu DI9Za6zEy0W75qbVr4wHW7C7DU7QsFKcZFK= -----END CERTIFICATE----- </pre>

Click **Regenerate** to open the Regenerate Self-Signed Certificate window. Enter all requested information including certificate name (used to differentiate different certificates), subject alternative name type and relational settings for subject name. Then click **GENERATE**.

Part IV Security



Firewall



CSM

While the broadband users demand more bandwidth for multimedia, interactive applications, or distance learning, security has been always the most concerned. The firewall of the Vigor router helps to protect your local network against attack from unauthorized outsiders. It also restricts users in the local network from accessing the Internet.

CSM is an abbreviation of Central Security Management which is used to control IM/P2P usage, filter the web content and URL content to reach a goal of security management.

IV-1 Firewall

Basic

A network firewall monitors traffic travelling between networks, with the ability to selectively allow or block traffic using a predefined set of security rules. This helps to maintain the integrity of networks by stopping unauthorized access and the exchange of sensitive information.

Firewall Facilities

LAN users are provided with secured protection by the following firewall facilities:

- User-configurable IP filter (Call Filter/ Data Filter).
- Stateful Packet Inspection (SPI): tracks packets and denies unsolicited incoming data
- Selectable Denial of Service (DoS) /Distributed DoS (DDoS) attacks protection

Data Filter

All traffic, both incoming and outgoing, that does not trigger a PPP connection attempt (either because a PPP connection is not necessary, or the required PPP connection has already been established) is checked against the Data Filter, and will be allowed or blocked according to the rules configured within.

The following flowcharts show how the router treats incoming traffic and outgoing traffic respectively.

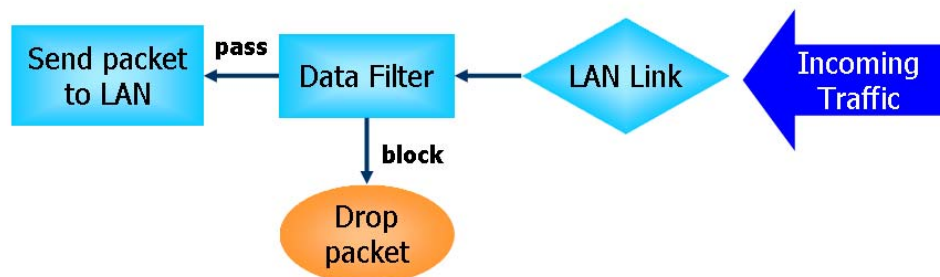

Stateful Packet Inspection (SPI)

Stateful inspection is a firewall architecture that works at the network layer. Unlike legacy static packet filtering, which examines a packet based on the information in its header, stateful inspection builds up a state machine to track each connection traversing all interfaces of the firewall and makes sure they are valid. The stateful firewall of Vigor router not only examines the header information also monitors the state of the connection.

Denial of Service (DoS) Defense

DoS attacks are categorized into two types: flooding-type attacks and vulnerability attacks. Flooding-type attacks attempts to exhaust system resources while vulnerability attacks attempts to paralyze the system by exploiting vulnerabilities of protocols or operation systems.

Vigor's DoS Defense functionality detects DoS attacks and mitigates their damage by inspecting every incoming packet, and malicious packets will be blocked. If Syslog is enabled, alert messages will also be sent. Abnormal traffic flow such as flood and port scan attacks that exceed allowable thresholds are also blocked.

The below shows the attack types that DoS/DDoS defense function can detect:

1. SYN flood attack
2. UDP flood attack
3. ICMP flood attack
4. Port Scan attack
5. IP options
6. Land attack
7. Smurf attack
8. Trace route
9. SYN fragment
10. Fraggle attack
11. TCP flag scan
12. Tear drop attack
13. Ping of Death attack
14. ICMP fragment
15. Unassigned Numbers

Web User Interface

Below shows the menu items for Firewall.

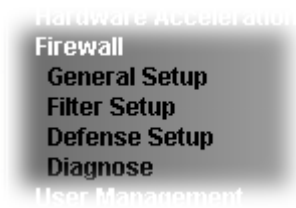

IV-1-1 General Setup

General Setup Page

Such page allows you to enable / disable Call Filter and Data Filter, determine general rule for filtering the incoming and outgoing data.

Firewall >> General Setup

General Setup

General Setup Default Rule

Data Filter Enable Start Filter Set: Set#1 Disable

Allow pass inbound fragmented large packets (required for certain games and streaming)

Enable Strict Security Firewall

Block routing connections initiated from WAN IPv4 IPv6

Note:

Packets are filtered by firewall functions in the following order:

- 1.Data Filter Sets and Rules
- 2.Block routing connections initiated from WAN
- 3.Default Rule

OK Cancel

Backup Firewall: Backup Restore Firewall: 選擇檔案 未選擇任何檔案 Restore

Note:

This will not backup the detail setting of Quality of Service and Schedule.

Available settings are explained as follows:

Item	Description
Data Filter	Select Enable to activate the Data Filter function, and then choose a Start Filter Set.

Allow pass inbound gragmented large...	<p>Certain games and video streaming service use fragmented UDP packets to transfer data. Enabling this option allows these applications to function properly.</p> <p>If this option is not enabled, the router will attempt to reassemble fragmented packets up to a certain value (e.g., 15xx-2102) kilobytes long. Packets larger than the certain value will be discarded.</p> <p>If this option is enabled, the router always passes fragmented packets without reassembling them, regardless of the size of the packet.</p>
Enable Strict Security Firewall	<p>If this option and the Web Content Filter (WCF) are both enabled, web traffic will be blocked if the WCF server fails to respond to lookup requests.</p>
Block routing packet from WAN	<p>IPv6 - IPv6 does not make use of Network Address Translation (NAT), so all LAN hosts receive public IPv6 IP addresses that are exposed to the WAN. Enable this option to block WAN hosts from connecting to LAN hosts using IPv6.</p> <p>IPv4 - For LAN hosts receiving WAN IPv4 addresses using the IP routed subnet, enable this option to prevent WAN hosts from connecting to LAN hosts. This option has no effect on LAN hosts on private LAN subnets.</p>
Backup Firewall	<p>Click Backup to save the firewall configuration.</p>
Restore Firewall	<p>Click Select to choose a firewall configuration file. Then click Restore to apply the file.</p>

To save changes on the page, click **OK**. To discard changes, click **Cancel**.

Traffic is filtered by firewall functions in the following order:

1. Data Filter Sets and Rules
2. Block connections initiated from WAN
3. Default Rule

Default Rule Page

Such page allows you to choose filtering profiles including QoS, User Management, APP Enforcement, URL Content Filter, Web Content Filter and DNS Filter for data transmission via Vigor router.

The default rule applies to all traffic that is not constrained by other filters or rules.

Firewall >> General Setup

General Setup

General Setup **Default Rule**

Actions for default rule:

Application	Action/Profile	Syslog
Filter	Pass ▼	<input type="checkbox"/>
Sessions Control	0 / 300000	<input type="checkbox"/>
<u>Quality of Service</u>	None ▼	<input type="checkbox"/>
<u>User Management</u>	None ▼	<input type="checkbox"/>
<u>APP Enforcement</u>	None ▼	<input type="checkbox"/>
<u>URL Content Filter</u>	None ▼	<input type="checkbox"/>
<u>Web Content Filter</u>	None ▼	<input type="checkbox"/>
<u>DNS Filter</u>	None ▼	<input type="checkbox"/>

Advance Setting

Backup Firewall: Restore Firewall: 未選擇任何檔案

Note:

This will not backup the detail setting of Quality of Service and Schedule.

Available settings are explained as follows:

Item	Description
Filter	Select Pass or Block for the packets that do not match with the filter rules. When the setting is Block , all other fields on the page are disabled because they are not applicable.
Sessions Control	The current number of sessions is shown before the slash, followed by the maximum number of concurrent sessions allowed, which is configurable. The default maximum is 60000, which is also the upper limit of the value.
Quality of Service	Choose one of the QoS rules to be applied as firewall rule. For detailed information of setting QoS, please refer to the related section later.
User Management	This setting is only available when Rule-Based is selected in User Management>>General Setup . The default firewall rule will be applied to the selected user or user group. Refer to the chapter on User Management for more details on the feature. <ul style="list-style-type: none"> ● None- User Management does not apply to the default rule.

	<ul style="list-style-type: none"> ● User Object-The default rule only applies to the selected user. ● [Create New User]- Select this to create a new user. ● User Group: The default rule only applies to the selected User Group. ● [Create New Group]- Select this to create a new user group. ● ALL- The default rule applies to all defined users. ● Create New User or Create New Group item will appear for you to click to create a new one if there is no user profile or group profile existed. <p>Syslog - Select to allow User Management to log messages in Syslog.</p>
APP Enforcement	<p>Select an APP Enforcement profile for application blocking, or None to disable APP Enforcement for the Default Rule. Select [Create New] from the dropdown list to create a new profile. Refer to the chapter on APP Enforcement for more details on the feature.</p> <p>Syslog - Select to allow APP Enforcement to log messages in Syslog.</p>
URL Content Filter	<p>Select a URL Content Filter profile to be used, or None to disable URL Content Filter for the Default Rule. Select [Create New] from the dropdown list to create a new profile. Refer to the chapter on URL Content Filter for more details on the feature.</p> <p>Syslog - Select to allow URL Content Filter to log messages in Syslog. Logging action is configured at the profile level in CSM>>URL Content Filter Profile, Log.</p>
Web Content Filter	<p>Select a Web Content Filter profile to be used, or None to disable Web Content Filter for the Default Rule. Select [Create New] from the dropdown list to create a new profile.</p> <p>Syslog - Select to allow Web Content Filter to log messages in Syslog. Logging action is configured at the profile level in the Web Content Filter Profile Table section in CSM>>Web Content Filter Profile, Log.</p>
DNS Filter	<p>Select the DNS Filter profile to be used, or None to disable DNS Filter for the Default Rule. Select [Create New] from the dropdown list to create a new profile.</p> <p>Syslog - Select to allow DNS Filter to log messages in Syslog. Logging action is configured at the profile level in the DNS Filter Profile Table section in CSM>>DNS Filter Profile, SysLog.</p>
Advance Setting	<p>Click Edit to open the configuration window for Advanced Settings. However, it is recommended to use the default settings.</p>

Firewall >> General Setup

Advance Setting	
Codepage	ANSI(1252)-Latin I
Window size:	65535
Session timeout:	1440 Minute

Codepage - Sets the codepage used by the URL content filter to match URLs against keywords in profiles. Choosing the appropriate codepage can increase the accuracy of the URL Content Filter. The default value is ANSI 1252 Latin I. If the setting is None, no decoding of URL will be performed.

If you are unsure of which codepage to use, please start the Syslog application, and the recommended codepage will be shown in the Codepage Information tab in the Setup dialog box.

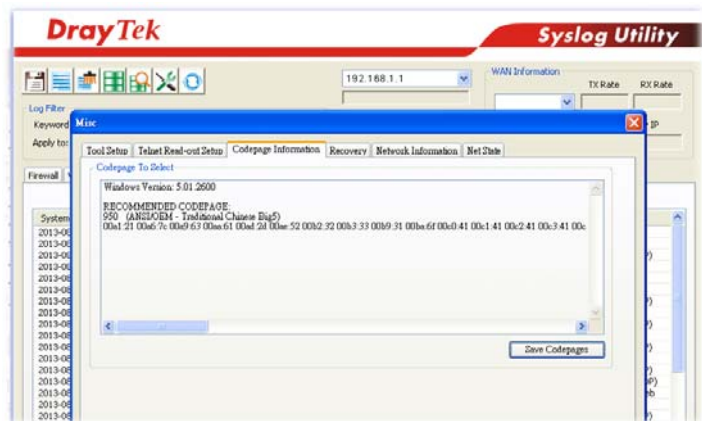

Window size - Sets the TCP window size as described in RFC 1323. Valid values are from 0 to 65535. The more the value is, the better the performance will be. However, if the network is not stable, small value will be proper.

Session timeout - Sets the timeout sessions are allowed to idle before they are removed from the system.

After finishing all the settings here, please click **OK** to save the configuration.

IV-1-2 Filter Setup

Click **Firewall** and click **Filter Setup** to bring up the setup page.

Firewall >> Filter Setup



Filter Setup				Set to Factory Default
Set	Comments	Set	Comments	
1.	Default Call Filter	26.		
2.	Default Data Filter	27.		
3.		28.		
4.		29.		
5.		30.		
6.		31.		
7.		32.		
8.		33.		
9.		34.		
10.		35.		
11.		36.		
12.		37.		
13.		38.		
14.		39.		
15.		40.		
16.		41.		
17.		42.		
18.		43.		
19.		44.		
20.		45.		
21.		46.		
22.		47.		
23.		48.		
24.		49.		
25.		50.		

To edit a filter set, click on its set number. The following Filter Set page will be shown. Each filter set contains up to 50 rules.

Firewall >> Filter Setup >> Edit Filter Set

Filter Set 1

Comments :

Rule	Enable	Comments	Direction	Src IP	Dst IP	Service Type	Action	CSM	Move Up	Move Down
1	<input checked="" type="checkbox"/>	Block NetBios	LAN/RT/VPN -> WAN	Any	Any	TCP/UDP, Port: from 137~139 to any	Block Immediately			Down
2	<input type="checkbox"/>		LAN/RT/VPN -> WAN	Any	Any	Any	Pass Immediately		UP	Down
3	<input type="checkbox"/>		LAN/RT/VPN -> WAN	Any	Any	Any	Pass Immediately		UP	Down
4	<input type="checkbox"/>		LAN/RT/VPN -> WAN	Any	Any	Any	Pass Immediately		UP	Down
5	<input type="checkbox"/>		LAN/RT/VPN -> WAN	Any	Any	Any	Pass Immediately		UP	Down
6	<input type="checkbox"/>		LAN/RT/VPN -> WAN	Any	Any	Any	Pass Immediately		UP	Down
7	<input type="checkbox"/>		LAN/RT/VPN -> WAN	Any	Any	Any	Pass Immediately		UP	Down
8	<input type="checkbox"/>		LAN/RT/VPN -> WAN	Any	Any	Any	Pass Immediately		UP	Down
9	<input type="checkbox"/>		LAN/RT/VPN -> WAN	Any	Any	Any	Pass Immediately		UP	Down

Available settings are explained as follows:

Item	Description
Rule	To edit the filter rule, click the filter rule number (1 ~ 30) to bring up the Edit Filter Rule page. See the following section for details on the Edit Filter Rule page.
Enable	Select to enable the filter rule.
Comments	Optional comment entered in the settings page to identify the rule.
Direction	Displays the direction of packet.
Src IP / Dst IP	Displays the IP address of source /destination.
Service Type	Displays the type and port number of the packet.
Action	Displays the packets to be passed /blocked.
CSM	Displays the content security managed
Move Up/Down	Use Up or Down link to change the order of the filter rules.
Next Filter Set	Select the filter set for the firewall to process after the current filter set, or None if the current filter set is the last one to be processed. Be careful not to create a loop when setting next filter sets.
Wizard Mode	Allow to configure frequently used settings for filter rule via several setting pages.
Advance Mode	Allow to configure detailed settings of filter rule.

To use Wizard Mode, simple do the following steps:

1. Click the **Wizard Mode** radio button.
2. Click **Index 1**. The setting page will appear as follows:

Firewall >> Edit Filter Set >> Edit Filter Rule Wizard

Filter Set 1 Rule 1

Firewall Rule applies to packets that meet the following criteria

Comments:

Direction:

Source IP:

Start IP Address:

End IP Address:

Subnet Mask:

Destination IP:

Start IP Address:

End IP Address:

Subnet Mask:

Protocol:

Source Port:

Destination Port:

Available settings are explained as follows:

Item	Description
------	-------------

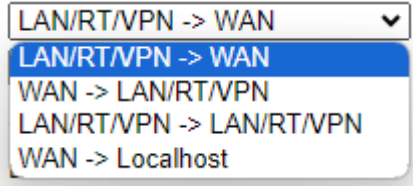
Comments	Enter filter set comments/description. Maximum length is 14- character long.
Direction	Set the direction of packet flow. It is for Data Filter only. For the Call Filter , this setting is not available since Call Filter is only applied to outgoing traffic.  Note: RT means routing domain for 2nd subnet or other LAN.
Source/Destination IP	To set the IP address manually, please choose Any Address/Single Address/Range Address/Subnet Address as the Address Type and type them in this dialog.
Protocol	Specify the protocol(s) which this filter rule will apply to.
Source Port / Destination Port	(=) - when the first and last value are the same, it indicates one port; when the first and last values are different, it indicates a range for the port and available for this service type. (!=) - when the first and last value are the same, it indicates all the ports except the port defined here; when the first and last values are different, it indicates that all the ports except the range defined here are available for this service type. (>) - the port number greater than this value is available. (<) - the port number less than this value is available for this profile.

- Click **Next** to get the following page.

Firewall >> Edit Filter Set >> Edit Filter Rule Wizard

Filter Set 1 Rule 1

Based on the settings in the previous pages, we guess you want to have: **Pass**
The current setting is:

Pass Immediately

APP Enforcement:

URL Content Filter:

Web Content Filter:

DNS Filter:

Block Immediately

Available settings are explained as follows:

Item	Description
Pass Immediately	Packets matching the rule will be passed immediately. APP Enforcement - Select an APP Enforcement profile for application blocking, or None to disable APP Enforcement for the Default Rule. Select [Create New] from the dropdown list to create a new profile. Refer to the chapter on APP Enforcement for more details on the feature. URL Content Filter - Select a URL Content Filter profile to

	<p>be used, or None to disable URL Content Filter for the Default Rule. Select [Create New] from the dropdown list to create a new profile. Refer to the chapter on URL Content Filter for more details on the feature.</p> <p>Web Content Filter - Select a Web Content Filter profile to be used, or None to disable Web Content Filter for the Default Rule. Select [Create New] from the dropdown list to create a new profile.</p> <p>DNS Filter - Select the DNS Filter profile to be used, or None to disable DNS Filter for the Default Rule. Select [Create New] from the dropdown list to create a new profile.</p>
Block Immediately	Packets matching the rule will be dropped immediately.

- After choosing the mechanism, click **Next** to get the summary page for reference.

Firewall >> Edit Filter Set >> Edit Filter Rule Wizard

Filter Set 1 Rule 1 Configuration Summary

Comments :	Block NetBios
Direction	
LAN/RT/VPN -> WAN	
Criteria	
Source IP	Any
Destination IP	Any
Protocol	TCP/UDP, Port: from 137 ~ 139 to any
More options	
Pass Immediately	
APP Enforcement :	None
URL Content Filter :	None
Web Content Filter :	1 - Default
DNS Filter :	None

- If there is no error, click **Finish** to complete wizard setting.

To use **Advance Mode**, do the following steps:

1. Click the **Advance Mode** radio button.
2. Click **Index 1** to access into the following page.

Firewall >> Edit Filter Set >> Edit Filter Rule

Filter Set 1 Rule 1

Enable

Comments: xNetBios -> DNS

Schedule Profile: None, None, None, None

Clear sessions when schedule is ON

Direction: LAN/RT/VPN -> WAN **Advanced**

Source IP/Country: Any

Destination IP/Country: Any

Service Type: TCP/UDP, Port:from 137~139 to53

Fragments: Don't Care

Application	Action/Profile	Syslog
Filter: Block Immediately		<input type="checkbox"/>
Branch to Other Filter Set: None		<input type="checkbox"/>
Sessions Control: 0 / 300000		<input type="checkbox"/>
MAC Bind IP: Non-Strict		<input type="checkbox"/>
Quality of Service : None		<input type="checkbox"/>
User Management : None		<input type="checkbox"/>
APP Enforcement : None		<input type="checkbox"/>
URL Content Filter : None		<input type="checkbox"/>
Web Content Filter : None		<input type="checkbox"/>
DNS Filter : None		<input type="checkbox"/>

Advance Setting

Available settings are explained as follows:

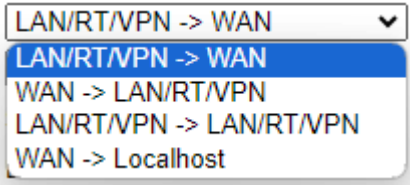
Item	Description
Enable	Check this box to enable the filter rule.
Comments	Enter filter set comments/description. Maximum length is 14- character long.
Schedule Profile	Select Schedule indexes to allow the rule to be enabled at specific times. You may choose up to 4 out of the 15 schedules in Applications >> Schedule. The rule is always enabled when no indexes have been selected.
Clear sessions when schedule is ON	Select this option to clear existing sessions when the rule is changes is enabled by a schedule profile. All connections will be reset.
Direction	Specify the direction of traffic flow to which this filter rule applies. Note that when the rule belongs to the Call Filter, the WAN -> LAN/RT/VPN option has no effect as Call Filter applies only to outgoing traffic. 

Note: RT stands for the routing domain for 2nd subnet or

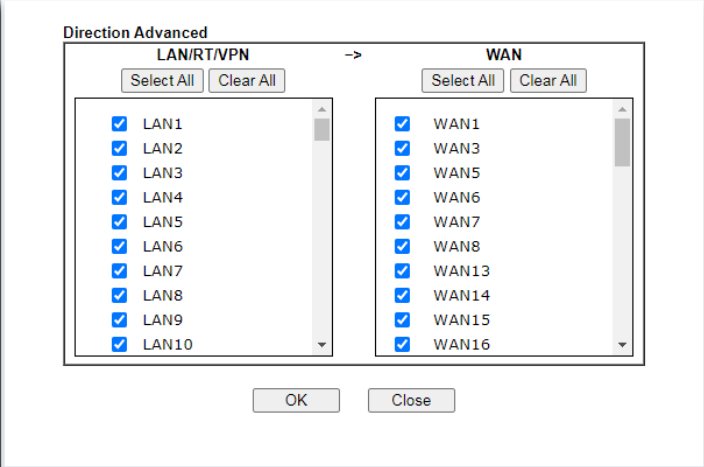
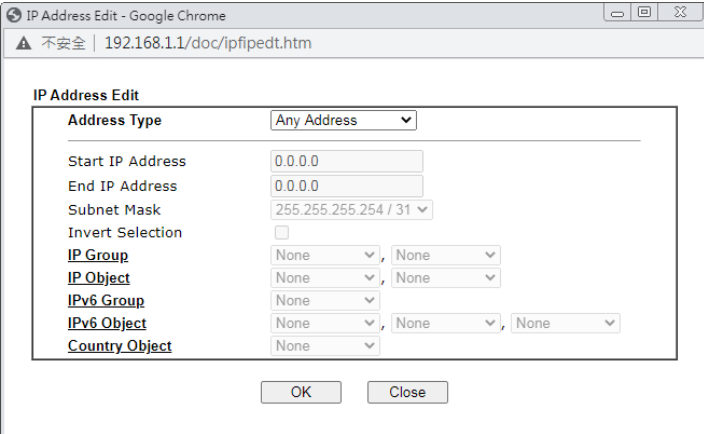
	<p>other LAN.</p> <p>Advanced - After choosing the direction, click the Advanced button to specify interfaces for traffic flow.</p> 
<p>Source IP/ Country and Destination IP / Country</p>	<p>Click Edit to bring up the following dialog box to configure the source and destination IP addresses or country objects.</p>  <p>To set the IP address manually, please choose an Address Type and enter required information.</p> <p>Address Type - Select from one of the following:</p> <ul style="list-style-type: none"> ● Any Address - All IP addresses ● Single Address - Enter one IP address in Start IP address ● Range Address - Enter the Start and End IP Addresses ● Subnet Address - Enter the Start IP Address and the Subnet Mask. Example: Start IP Address 192.168.1.1 and Subnet Mask 255.255.255.128 means is the same as having the Start IP Address as 192.168.1.1 and the End IP Address as 192.168.1.127. ● Group and Objects - Allows selection of predefined IP Groups and IP Objects. For details on IP Groups and Objects, see the chapter on Objects Setting. ● Country Object - Allows selection of predefined country objects.
<p>Service Type</p>	<p>Click Edit to bring up the following dialog box to configure the Service Type.</p>

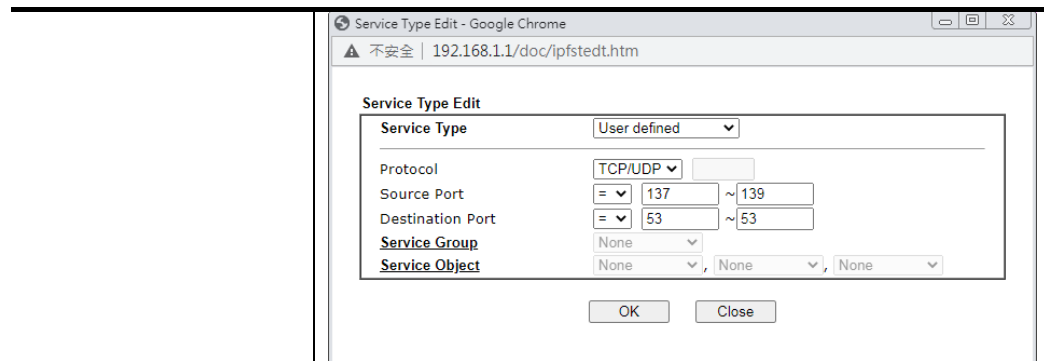

Service Type - To set the service type manually, please choose **User defined** as the Service Type.

- **User defined** - Configure the protocol, source and destination ports manually.
- **Group and Objects** - Select preconfigured Service Groups or Objects.

Protocol - Specify the protocol(s) which this filter rule will apply to.

Source/Destination Port -

- (=) - any port that falls within the specified range
- (!=) - any port that falls outside of the specified range
- (>) - a port whose number is greater than the specified value
- (<) - a port whose number is smaller than the specified value

Service Group/Object - Use the drop down list to select the desired Service Groups or Objects.

<p>Fragments</p>	<p>Action to be taken for fragmented packets. This option is valid for Data Filter rules only.</p> <p>Don't care -No action will be taken towards fragmented packets.</p> <p>Unfragmented -Apply the rule to unfragmented packets.</p> <p>Fragmented - Apply the rule to fragmented packets.</p> <p>Too Short - Apply the rule only to packets that are too short to contain a complete header.</p>
<p>Filter</p>	<p>Action to be taken when packets match the rule.</p> <p>Block Immediately - Packets matching the rule will be dropped immediately.</p> <p>Pass Immediately - Packets matching the rule will be passed immediately.</p> <p>Block If No Further Match - Block the packet if this the last matching rule for this packet in the filter.</p> <p>Pass If No Further Match - Pass the packet if this is the last matching rule for this packet in the filter.</p>
<p>Branch to other Filter Set</p>	<p>If the packet matches the filter rule, and the Filter action is Block If No Further Match or Pass If No Further Match, you can specify the next filter set to be applied, thus skipping the rest of the rules in the current filter set.</p>
<p>Sessions Control</p>	<p>The current number of sessions is shown before the slash, followed by the maximum number of concurrent sessions allowed, which is configurable. The default maximum is 60000, which is also the upper limit of the value.</p>

MAC Bind IP	<p>Strict - Ensure that both the MAC address and the IP address of the source and/or destination clients.</p> <p>Non-Strict - Do not check the IP address when processing IP Objects that specify MAC addresses.</p>
Quality of Service	<p>Choose one of the QoS rules to be applied as firewall rule. For detailed information of setting QoS, please refer to the related section later.</p>
User Management	<p>This setting is only available when Rule-Based is selected in User Management>>General Setup. The default firewall rule will be applied to the selected user or user group. Refer to the chapter on User Management for more details on the feature.</p> <ul style="list-style-type: none"> ● None- User Management does not apply to the default rule. ● User Object- The default rule only applies to the selected user. ● [Create New User]- Select this to create a new user. ● User Group: The default rule only applies to the selected User Group. ● [Create New Group]- Select this to create a new user group. ● ALL-The default rule applies to all defined users. ● Create New User or Create New Group item will appear for you to click to create a new one if there is no user profile or group profile existed. <p>Syslog - Select to allow User Management to log messages in Syslog.</p>
APP Enforcement	<p>Select an APP Enforcement profile for application blocking, or None to disable APP Enforcement for the Default Rule. Select [Create New] from the dropdown list to create a new profile. Refer to the chapter on APP Enforcement for more details on the feature.</p> <p>Syslog - Select to allow APP Enforcement to log messages in Syslog.</p>
URL Content Filter	<p>Select a URL Content Filter profile to be used, or None to disable URL Content Filter for the Default Rule. Select [Create New] from the dropdown list to create a new profile. Refer to the chapter on URL Content Filter for more details on the feature.</p> <p>Syslog - Select to allow URL Content Filter to log messages in Syslog. Logging action is configured at the profile level in CSM>>URL Content Filter Profile, Log.</p>
Web Content Filter	<p>Select a Web Content Filter profile to be used, or None to disable Web Content Filter for the Default Rule. Select [Create New] from the dropdown list to create a new profile.</p> <p>Syslog - Select to allow Web Content Filter to log messages in Syslog. Logging action is configured at the profile level in the Web Content Filter Profile Table section in CSM>>Web Content Filter Profile, Log.</p>
DNS Filter	<p>Select the DNS Filter profile to be used, or None to disable DNS Filter for the Default Rule. Select [Create New] from the dropdown list to create a new profile.</p> <p>Syslog - Select to allow DNS Filter to log messages in Syslog.</p>

Logging action is configured at the profile level in the DNS Filter Profile Table section in CSM>>DNS Filter Profile, SysLog.

Advance Setting

Click **Edit** to open the configuration window for Advanced Settings. However, it is recommended to use the default settings.

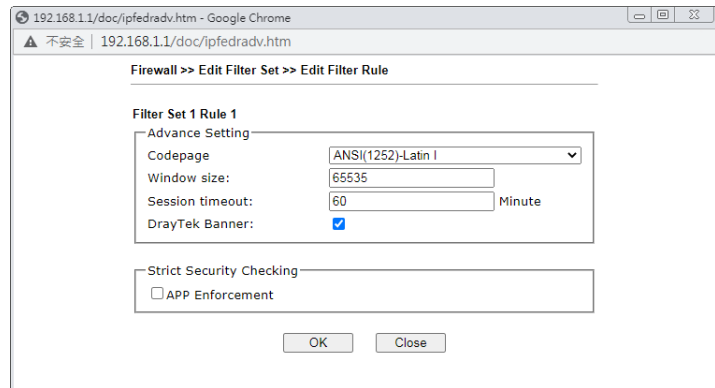

Codepage - Sets the codepage used by the URL content filter to match URLs against keywords in profiles. Choosing the appropriate codepage can increase the accuracy of the URL Content Filter. The default value is ANSI 1252 Latin I. If the setting is None, no decoding of URL will be performed. If you are unsure of which codepage to use, please start the Syslog application, and the recommended codepage will be shown in the Codepage Information tab in the Setup dialog box.

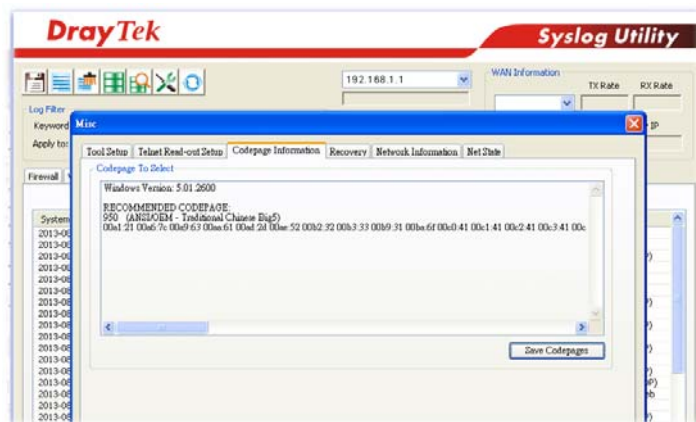

Window size - Sets the TCP window size as described in RFC 1323. Valid values are from 0 to 65535. The more the value is, the better the performance will be. However, if the network is not stable, small value will be proper.

Session timeout - Sets the timeout sessions are allowed to idle before they are removed from the system.

DrayTek Banner - Select to display the following screen for web pages that are blocked by the Firewall. The default setting is Enabled.

The requested Web page has been blocked by Web Content Filter.

Please contact your system administrator for further information.

[Powered by Draytek]

Strict Security Checking

APP Enforcement - If this option is selected, when the router cannot identify the application that generated the outbound traffic due to limited system resources, the session will be blocked; if this option is not selected, the session will be allowed.

3. When you finish the configuration, please click **OK** to save and exit this page.

IV-1-3 Defense Setup

As a sub-functionality of IP Filter/Firewall, there are 15 types of detect/ defense function in the DoS Defense setup. The DoS Defense functionality is disabled for default.

IV-1-3-1 DoS Defense

To configure DoS Defense, select DoS Defense under the Firewall menu item on the Web UI menu bar.

Firewall >> Defense Setup

DoS Defense
Spoofing Defense

DoS defense

Enable DoS Defense
 Select All
White/Black List Option

Log: Enable

<input type="checkbox"/> Enable SYN flood defense	Threshold	<input type="text" value="2000"/>	packets / sec	
	Timeout	<input type="text" value="10"/>	sec	
<input type="checkbox"/> Enable UDP flood defense	Threshold	<input type="text" value="2000"/>	packets / sec	
	Timeout	<input type="text" value="10"/>	sec	
<input type="checkbox"/> Enable ICMP flood defense	Threshold	<input type="text" value="250"/>	packets / sec	
	Timeout	<input type="text" value="10"/>	sec	
<input type="checkbox"/> Enable Port Scan detection	Threshold	<input type="text" value="2000"/>	packets / sec	
<input type="checkbox"/> Block IP options	<input type="checkbox"/> Block TCP flag scan			
<input type="checkbox"/> Block Land	<input type="checkbox"/> Block Tear Drop			
<input type="checkbox"/> Block Smurf	<input type="checkbox"/> Block Ping of Death			
<input type="checkbox"/> Block trace route	<input type="checkbox"/> Block ICMP fragment			
<input type="checkbox"/> Block SYN fragment	<input type="checkbox"/> Block Unassigned Numbers			
<input type="checkbox"/> Block Fraggle Attack				

OK
Clear All
Cancel

Available settings are explained as follows:

Item	Description
Enable Dos Defense	Select to enable DoS Defense. Select All - Click to select all DoS Defense options. White/Black List Option - Set white/black list of IPv4/IPv6 address.
Enable SYN flood defense	Select to enable SYN flood defense. When the arrival rate of SYN packets exceeds the Threshold value, the router will start to randomly discard TCP SYN packets for a period of time as defined in Timeout. This is to prevent TCP SYN packets from exhausting router resources. The default values of threshold and timeout are 2000 packets per second and 10 seconds, respectively.
Enable UDP flood defense	Select to enable UDP flood defense. When the arrival rate of UDP packets exceeds the Threshold value, the router will start to randomly discard TCP SYN packets for a period of time as defined in Timeout. The default values of threshold and timeout are 2000

	packets per second and 10 seconds, respectively.
Enable ICMP flood defense	<p>Select to enable ICMP flood defense. When the arrival rate of ICMP packets exceeds the Threshold value, the router will start to randomly discard TCP SYN packets for a period of time as defined in Timeout.</p> <p>The default values of threshold and timeout are 250 packets per second and 10 seconds, respectively.</p>
Enable PortScan detection	<p>Select to enable Port Scan detection. Port Scans attack your network by sending packets to a range of ports in an attempt to find services that would respond. When Port Scan detection is enabled, the router sends warning messages when it detects port scanning activities that exceed the Threshold rate.</p> <p>The default threshold is 2000 packets per second.</p>
Block IP options	<p>Select to enable Block IP options. The Vigor router will ignore IP packets with IP option field set in the datagram header. IP options are rarely used and could be abused by attackers as they carry information about the private network otherwise not available to the external network, such as security, TCC (closed user group) parameters, a series of Internet addresses, routing messages, etc, which external eavesdroppers can use to discover details about the private network.</p>
Block Land	<p>Select to Block LAND attacks. LAND attacks happen when an attacker sends spoofed SYN packets with both source and destination addresses set to that of the target system, which causes the target to reply to itself continuously.</p>
Block Smurf	<p>Select to Block Smurf attacks. The router will ignore any broadcasting ICMP echo request.</p>
Block trace route	<p>Select to Block traceroutes. The router will not forward traceroute packets.</p>
Block SYN fragment	<p>Select to Block SYN packet fragments. The router will drop any packets having both the SYN and more-fragments bits set.</p>
Block Fraggle Attack	<p>Select to Block Fraggle Attacks. Broadcast UDP packets received from the Internet are blocked.</p> <p>Activating this feature might block some legitimate packets. Since all broadcast UDP packets coming from the Internet are blocked, RIP packets from the Internet could also be dropped.</p>
Block TCP flag scan	<p>Select to Block TCP Flag Scans. TCP packets with abnormal flag settings will be dropped. TCP flag scanning activities that are blocked include no flag scan, FIN without ACK scan, SYN FIN scan, Xmas scan and full Xmas scan.</p>
Block Tear Drop	<p>Select to Block Tear Drop attacks. Some clients may crash when they receive ICMP datagrams (packets) that exceed the maximum length. The router discards any fragmented ICMP packets having lengths greater than 1024 octets.</p>
Block Ping of Death	<p>Select to Block Ping of Death, where fragmented ping packets are sent to target hosts so that those hosts could crash as they reassemble the malformed ping packets.</p>
Block ICMP Fragment	<p>Select to Block ICMP Fragments. ICMP packets with the more-fragments bit set are dropped.</p>

Block Unassigned Numbers

Select to Block Unassigned Protocol Numbers, and the router will block packets having unassigned protocol numbers. Individual IP packet has a protocol field in the datagram header to indicate the protocol type running over the upper layer. However, the protocol types greater than 100 are reserved and undefined at this time. Therefore, the router should have ability to detect and reject this kind of packets.

Warning Messages

We provide Syslog function for user to retrieve message from Vigor router. The user, as a Syslog Server, shall receive the report sending from Vigor router which is a Syslog Client.

All the warning messages related to DoS Defense will be sent to user and user can review it through Syslog daemon. Look for the keyword DoS in the message, followed by a name to indicate what kind of attacks is detected.

System Maintenance >> SysLog / Mail Alert Setup

SysLog / Mail Alert Setup

SysLog Access Setup

- Enable
- Syslog Save to:
 - Syslog Server
- Router Name: DrayTek
- Server IP/Hostname: _____
- Destination Port: 514
- Mail Syslog: Enable
- Enable syslog message:
 - Firewall Log
 - VPN Log
 - User Access Log / Hotspot User Information
 - WAN Log
 - Router/DSL information

Mail Alert Setup

- Enable
- Interface: Any
- SMTP Server: _____
- SMTP Port: 25
- Mail To: _____
- Sender Address: _____
- Connection Security: Plaintext
- Authentication
- Username: _____
- Password: _____
- Enable E-Mail Alert:
 - DoS Attack
 - APPE
 - VPN LOG
 - Debug Log

Send a test e-mail

Note:

- 1. Mail Syslog feature will send the Syslog when it is full.

OK Clear

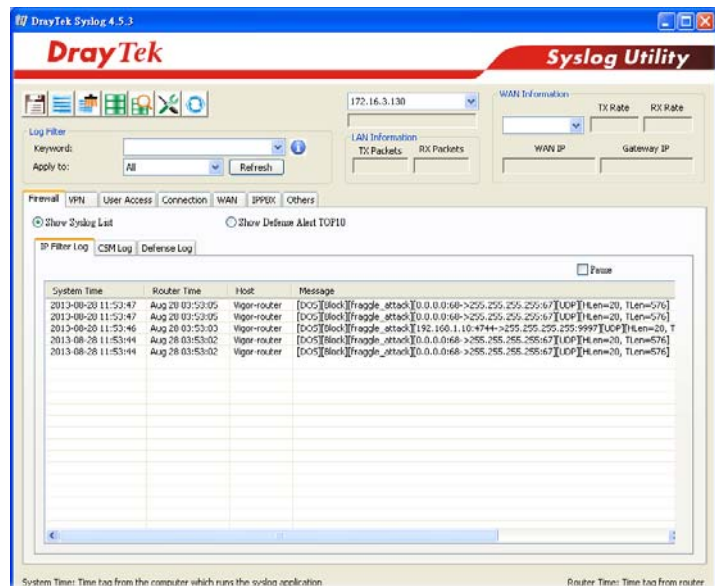

After finishing all the settings here, please click OK to save the configuration.

IV-1-3-2 Spoofing Defense

Click the Spoofing Defense tab to open the setup page.

Firewall >> Defense Setup

DoS Defense
Spoofing Defense

ARP Spoofing Defense Log: Enable ▼

Block ARP replies with inconsistent source MAC addresses.
 Block ARP replies with inconsistent destination MAC addresses.
 Decline VRRP MAC into ARP table.

IP Spoofing Defense

Block IP packet from WAN with inconsistent source IP addresses.
 Block IP packet from LAN with inconsistent source IP addresses.

IV-1-4 Diagnose

The purpose of this function is to test when the router receiving incoming packet, which firewall rule will be applied to that packet. The test result, including firewall rule profile, IP address translation in packet transmission, state of the firewall functions and etc., also will be shown on this page.



Info

The result obtained by using Diagnose is offered for RD debug. It will be different according to actual state such as network connection, LAN/WAN settings and so on.

Firewall >> Diagnose

Mode
 ICMP UDP TCP IPv4 ▼

Direction
From LAN ▼

Test View

A

LAN

B

Src IP

Src Port

Src MAC

Dst IP

Dst Port

Packet & Payload

Packet	Enable	Direction	Protocol
1	<input checked="" type="checkbox"/>	A->B ▼	UDP:Customize
2	<input type="checkbox"/>	A->B ▼	UDP:Customize

Note:
This is firewall live test which need setup WAN and plug cable in.

Available settings are explained as follows:

Item	Description
Mode	To have a firewall rule test, specify the service type (ICMP,

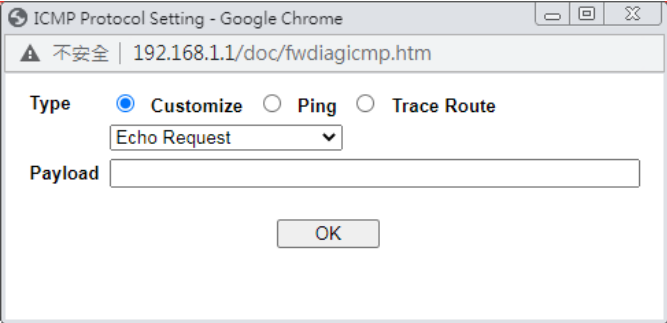
	UDP, TCP) of the packet and type of the IP address (IPv4/IPv6).
Direction	Set the way (from WAN or from LAN) that Vigor router receives the first packet for test. Different way means the firewall will process the connection initiated from LAN or from WAN.
Test View	This is a dynamic display page. According to the direction specified, test view will display the figure to guide you typing IP address, port number, and MAC address. Later, after clicking the Analyze button, the information for the firewall rule profile and address translation will be shown on this page.
Src IP	Enter the IPv4/IPv6 address of the packet's source.
Src Port	Enter the port number of the packet's source.
Src MAC	Enter the MAC address of the packet's source.
Dst IP	Enter the IPv4/IPv6 address of the packet's destination.
Dst Port	Enter the port number of the packet's destination.
Packet & Payload	<p>In firewall diagnose, two packets belong to one connection. In general, two packets are enough for Vigor router to perform this test.</p> <p>Enable - Check the box to send out the test packet.</p> <p>Direction - The first packet of the firewall test will follow the direction specified above. However, the direction for the second packet might be different. Simply choose the direction (from Computer A to B or from the B to A) for the second packet.</p> <p>Protocol - It displays the mode selected above and the sate. If required, click the mode link to configure advanced setting. The common service type (Customize, Ping, Trace Route / Customize, DNS, Trace Route / Customize, Http(GET) related to that mode (ICMP / UDP / TCP) will be shown on the following dialog box.</p>  <ul style="list-style-type: none"> ● Type - Choose Customize, Ping, Trace Route / Customize, DNS, Trace Route / Customize, Http (GET). ● Payload - It is available when Customzie is selected. Simply type 16 HEX characters which represent certain packet (e.g., DNS packet) if you want to set the data transfered with protocol (ICMP/UDP/TCP) which is different to Type setting.
Analyze	Execute the test and analyze the result.

The following figure shows the test result after clicking **Analyze**. Processing state for the functions (MAC Filter, QoS, User management, etc.) related to the firewall will be displayed by green or red LED.

Firewall >> Diagnose

Mode
 ICMP UDP TCP IPv4 ▾

Direction
 From LAN ▾

Test View

A

192.168.1.111:22222
->7.7.7.7:51348

LAN

Firewall

WAN1

7.7.7.7:51348
172.16.2.234:62094<-

B

Status	Packet	Set	Rule	UCF/WCF
Pass	2	default	default	n/a

Packet & Payload

Packet	Enable	Direction	Protocol			
1	<input checked="" type="checkbox"/>	A->B ▾	UDP:Customize			
Acceleration						
2	<input checked="" type="checkbox"/>	B->A ▾	UDP:Customize			
Acceleration						
<input checked="" type="checkbox"/> SESS CTL	<input checked="" type="checkbox"/> MAC FILTER	<input checked="" type="checkbox"/> PCAP	<input checked="" type="checkbox"/> USER MGT	<input checked="" type="checkbox"/> APPE	<input checked="" type="checkbox"/> UCF	<input checked="" type="checkbox"/> WCF
<input checked="" type="checkbox"/> DNSF	<input checked="" type="checkbox"/> SESS LMT	<input checked="" type="checkbox"/> BW LMT	<input checked="" type="checkbox"/> QOS	<input checked="" type="checkbox"/> APP_QOS	<input checked="" type="checkbox"/> HW ACC	

APP: The APP need to check. : The APP is completed.
 APP: The APP doesn't need to check. : The APP is processing.

Note:
 PCAP is "ip pcap" in telnet command.

<<Back Reset

Application Notes

A-1 How to Configure Certain Computers Accessing to Internet

We can specify certain computers (e.g., 192.168.1.10 ~ 192.168.1.20) accessing to Internet through Vigor router. Others (e.g., 192.168.1.31 and 192.168.1.32) outside the range can get the source from LAN only.

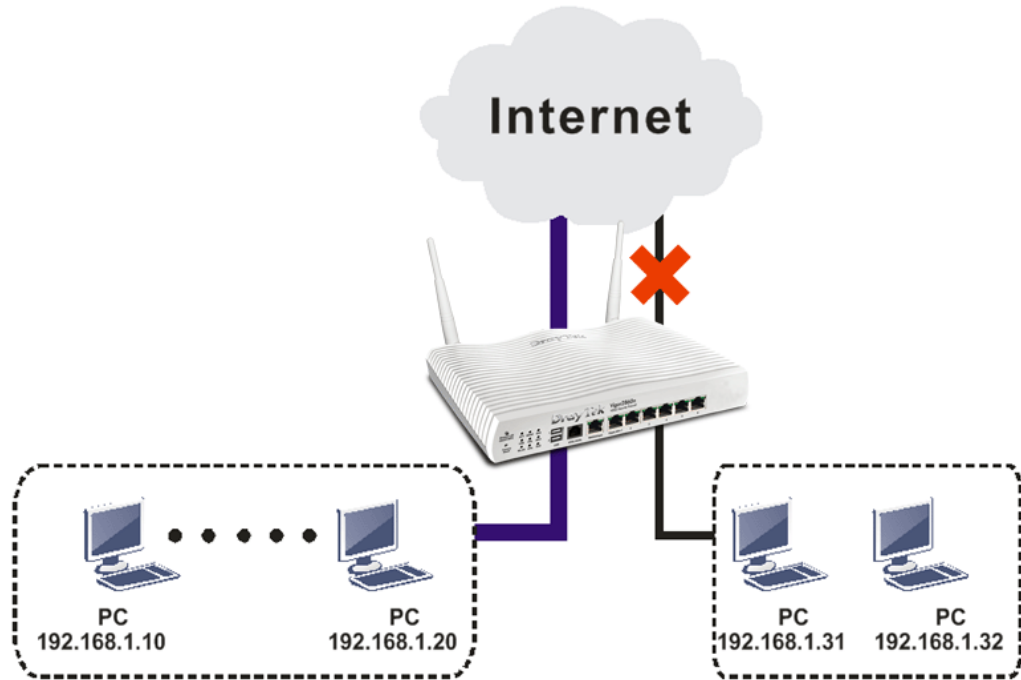

The way we can use is to set two rules under Firewall. For Rule 1 of Set 2 under Firewall>>Filter Setup is used as the default setting, we have to create a new rule starting from Filter Rule 2 of Set 2.

1. Access into the web user interface of Vigor router.
2. Open Firewall>>Filter Setup. Click the Set 2 link and choose the Filter Rule 2 button.

Firewall >> Filter Setup

Filter Setup				Set to Factory Default
Set	Comments	Set	Comments	
1.	Default Call Filter	7.		
2.	Default Data Filter	8.		
3.		9.		
4.		10.		
5.		11.		
6.		12.		

Firewall >> Filter Setup >> Edit Filter Set

Filter Set 1

Comments :

Rule	Enable	Comments	Direction	Src IP	Dst IP	Service Type	Action	CSM	Move Up	Move Down
1	<input checked="" type="checkbox"/>	Block NetBios	LAN/RT/VPN -> WAN	Any	Any	TCP/UDP, Port: from 137~139 to any	Block Immediately			Down
2	<input type="checkbox"/>		LAN/RT/VPN -> WAN	Any	Any	Any	Pass Immediately		UP	Down
			LAN/RT/VPN							

3. Check **Enable** to enable the filter rule. Type the comments (e.g., **block_all**). Choose **Block If No Further Match** for the **Filter** setting. Then, click **OK**.

Firewall >> Edit Filter Set >> Edit Filter Rule

Filter Set 1 Rule 2

Enable

Comments:

Schedule Profile: , , ,

Clear sessions when schedule is ON

Direction: LAN/RT/VPN -> WAN

Source IP/Country:

Destination IP/Country:

Service Type:

Fragments:

Application:

Filter: Syslog

Branch to Other Filter Set:



Info

In default, the router will check the packets starting with Set 2, Filter Rule 2 to Filter Rule 7. If Block If No Further Match for is selected for Filter, the firewall of the router would check the packets with the rules starting from Rule 3 to Rule 7. The packets not matching with the rules will be processed according to Rule 2.

4. Next, set another rule. Just open **Firewall>>Filter Setup**. Click the **Set 2** link and choose the **Filter Rule 3** button.
5. Check **Enable** to enable the filter rule. Type the comments (e.g., **open_ip**). Click the **Edit** button for **Source IP**.

Firewall >> Edit Filter Set >> Edit Filter Rule

Filter Set 1 Rule 3

Enable

Comments:

Schedule Profile: , , ,

Clear sessions when schedule is ON

Direction: LAN/RT/VPN -> WAN

Source IP/Country:

Destination IP/Country:

Service Type:

Fragments:

- A dialog box will be popped up. Choose **Range Address** as **Address Type** by using the drop down list. Type 192.168.1.10 in the field of **Start IP**, and type 192.168.1.20 in the field of **End IP**. Then, click **OK** to save the settings. The computers within the range can access into the Internet.

IP Address Edit

Address Type Range Address

Start IP Address 192.168.1.10

End IP Address 192.168.1.20

Subnet Mask 255.255.255.254/31

Invert Selection

IP Group None, None

IP Object None, None

IPv6 Group None

IPv6 Object None, None, None

Country Object None

OK Close

- Now, check the content of **Source IP** is correct or not. The action for **Filter** shall be set with **Pass Immediately**. Then, click **OK** to save the settings.

Firewall >> Edit Filter Set >> Edit Filter Rule

Filter Set 1 Rule 3

Enable

Comments open_ip

Schedule Profile None, None, None, None

Clear sessions when schedule is ON

Direction LAN/RT/VPN -> WAN Advanced

Source IP/Country 192.168.1.10~192.168.1.20 Edit

Destination IP/Country Any Edit

Service Type Any Edit

Fragments Don't Care

Application Action/Profile Syslog

Filter Pass Immediately

[Branch to Other Filter Set](#)

- Both filter rules have been created. Click **OK**.

Firewall >> Filter Setup >> Edit Filter Set

Filter Set 1

Comments : Default Call Filter

Rule	Enable	Comments	Direction	Src IP	Dst IP	Service Type	Action	CSN
1	<input checked="" type="checkbox"/>	Block NetBios	LAN/RT/VPN -> WAN	Any	Any	TCP/UDP, Port: from 137~139 to any	Block Immediately	
2	<input checked="" type="checkbox"/>	block_all	LAN/RT/VPN -> WAN	Any	Any	Any	Block If No Further Match	
3	<input checked="" type="checkbox"/>	open_ip	LAN/RT/VPN -> WAN	192.168.1.10 ~ 192.168.1.20	Any	Any	Pass Immediately	
4	<input type="checkbox"/>		LAN/RT/VPN -> WAN	Any	Any	Any	Pass Immediately	

Now, all the settings are configured well. Only the computers with the IP addresses within 192.168.1.10 ~ 192.168.1.20 can access to Internet.

IV-2 CSM (Central Security Management)

Content Security Management (CSM) allows the network administrator to restrict Internet traffic based on the content type, thus ensuring appropriate use of network resources and also reducing the likelihood of threats from malicious network content.

APP Enforcement Filter

The APP Enforcement Filter can be used to prevent users from using undesirable or inappropriate network applications such as online chat and peer-to-peer programs. The filter works by detecting and blocking network traffic of applications by means of traffic patterns.

URL Content Filter

The URL Content Filter scans URL strings in HTTP requests for predefined keywords to restrict browsing activities.

Web Content Filter

Users can also be prevented from browsing certain types of websites by using the Web Content Filter. This filter classifies website domain names into different categories, which can be selectively blocked.

Filter profiles must first be created before these CSM Filters can be enabled. Once profiles have been configured, they can be applied to the Default Rule under Firewall>>General Setup, or Filter Rules in Filter Sets under Firewall>>Filter Setup.



Info

The priority of URL Content Filter is higher than Web Content Filter.

Web User Interface

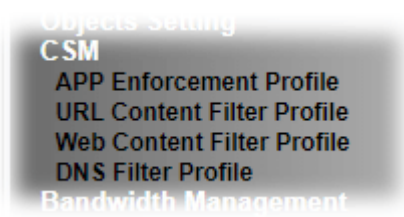

IV-2-1 APP Enforcement Profile

Up to 32 policy profiles for APP Enforcement can be configured.

CSM >> APP Enforcement Profile



APPE Module Version: 15.29 [APPE Support List](#)

APP Enforcement Profile Table:

[Set to Factory Default](#)

Profile	Name	Profile	Name
1.		17.	
2.		18.	
3.		19.	
4.		20.	
5.		21.	
6.		22.	
7.		23.	
8.		24.	
9.		25.	
10.		26.	
11.		27.	
12.		28.	
13.		29.	
14.		30.	
15.		31.	
16.		32.	

Note:

To make APP Enforcement profile effective, please go to [Firewall >> Filter Setup](#) page to create a firewall rule and select the desired profile.

Available settings are explained as follows:

Item	Description
Set to Factory Default	Clear all profile settings.
Profile	Index of the profile. Click to bring up the configuration page of the profile.
Name	Name of the profile.

To configure a profile, click on its profile number, and the following profile configuration page will appear:

CSM >> APP Enforcement Profile

Profile Index : 1
 Profile Name:

Category	Application		
Instant Message <input type="button" value="Select All"/> <input type="button" value="Clear All"/>	<input type="checkbox"/> AIM Login	<input type="checkbox"/> AliWW	<input type="checkbox"/> Ares
	<input type="checkbox"/> BaiduHi	<input type="checkbox"/> Facebook/Instagram	<input type="checkbox"/> Fetion
	<input type="checkbox"/> GaduGadu Protocol	<input type="checkbox"/> ICQ	<input type="checkbox"/> iSpQ
	<input type="checkbox"/> KC	<input type="checkbox"/> LINE	<input type="checkbox"/> LinkedIn
	<input type="checkbox"/> Paltalk	<input type="checkbox"/> PocoCall	<input type="checkbox"/> Qnext
	<input type="checkbox"/> Signal	<input type="checkbox"/> Slack	<input type="checkbox"/> Snapchat
	<input type="checkbox"/> Telegram	<input type="checkbox"/> Tencent QQ	<input type="checkbox"/> UC
	<input type="checkbox"/> WebIM URLs	<input type="checkbox"/> WhatsApp	<input type="checkbox"/> WhatsApp Call
	<input type="checkbox"/> Zalo		
	VoIP <input type="button" value="Select All"/> <input type="button" value="Clear All"/>	<input type="checkbox"/> RC Voice	<input type="checkbox"/> Skype/Teams
<input type="checkbox"/> TelTel		<input type="checkbox"/> WeChat	
P2P <input type="button" value="Select All"/> <input type="button" value="Clear All"/>	<input type="checkbox"/> Ares	<input type="checkbox"/> BitTorrent	<input type="checkbox"/> ClubBox
	<input type="checkbox"/> eDonkey	<input type="checkbox"/> FastTrack	<input type="checkbox"/> Gnutella
	<input type="checkbox"/> Huntmine	<input type="checkbox"/> Kuwo	<input type="checkbox"/> OpenFT
	<input type="checkbox"/> OpenNap	<input type="checkbox"/> Pando	<input type="checkbox"/> SoulSeek
	<input type="checkbox"/> Vagaa	<input type="checkbox"/> Xunlei(Thunder)	

Available settings are explained as follows:

Item	Description
Profile Name	Name that identifies this profile. Maximum length is 15 characters.
Category	Apps are classified into several categories. Each category contains several apps to be blocked.
Select All	Click to select all of the items on this page.
Clear All	Click to deselect all selected items.
Enable	Select this checkbox to block the app.

To save changes on the page, click OK. To discard changes, click Cancel.

IV-2-2 URL Content Filter Profile

To set up URL Content Filter Profiles, click **CSM** on the Main Menu bar, and then click **URL Content Filter Profile** to open the profile setting page.

CSM >> URL Content Filter Profile



URL Content Filter Profile Table:

| [Set to Factory Default](#) |

Profile	Name	Profile	Name
1.		5.	
2.		6.	
3.		7.	
4.		8.	

Note:

To make URL Content Filter profile effective, please go to [Firewall >> Filter Setup](#) page to create a firewall rule and select the desired profile.

Administration Message (Max 255 characters)

Default Message

```
<body><center><br><p>The requested Web page has been blocked by URL Content Filter.<p>Please contact your system administrator for further information.</center></body>
```

OK

Each item is explained as follows:

Item	Description
Set to Factory Default	Clear all profile settings.
Profile	Index number of the profile.
Name	Name that identifies the profile.
Administration Message	The message to be displayed in the browser when access to a URL has been blocked. A custom message can be entered with HTML formatting in the text box. Default Message - Click to reset the administration message to the factory default.

To set up a profile, click the profile number under Index column to bring up the configuration page.

Profile Index: 1

Profile Name:

Priority: Log:

URL Access Control

Enable URL Access Control Prevent web access from IP address

Action: Group/Object Selections:

Exception List

Web Feature

Enable Web Feature Restriction

Action: **File Extension Profile:** Cookie Proxy Upload

Available settings are explained as follows:

Item	Description
Profile Name	Name that identifies the URL Content Filter profile. The maximum length of the Profile Name is 15 characters.
Priority	<p>The order of evaluation of URL Access Control and Web Feature below:</p> <p>Both: Pass - Router will allow access only to web resources that match conditions specified in both URL Access Control and Web Feature. The Action setting of both URL Access Control and Web Feature will be disabled and the values set to Pass.</p> <p>Both:Block - Router will block access to web resources that match conditions specified in both URL Access Control and Web Feature. The Action setting of both URL Access Control and Web Feature will be disabled and the values set to Block.</p> <p>Either: URL Access Control First - Router will block or allow access to web resources that match conditions specified in either URL Access Control or Web Feature. URL Access Control is applied first, followed by Web Feature.</p> <p>Either: Web Feature First - Router will block or allow access to web resources that match conditions specified in either URL Access Control or Web Feature. Web Feature is applied first, followed by URL Access Control.</p>
Log	<p>Pass - Only passed access attempts will be recorded in Syslog.</p> <p>Block - Only blocked access attempts will be recorded in Syslog.</p> <p>All - Both passed and blocked access attempts will be recorded in Syslog.</p>
URL Access Control	<p>Enable URL Access Control - Select to activate URL Access Control.</p> <p>Prevent web access from IP address - URLs containing IP addresses (e.g., 192.168.1.1) will be blocked. Only URLs with domain addresses (e.g., www.draytek.com) will be allowed.</p>

This is to prevent users from circumventing URL Access Control.

Action - This setting is enabled only when Priority is set to Either: URL Access Control First or Either: Web Feature First.

- **Pass** - Allows access to web pages with URLs containing keywords that are in the selected keyword groups or objects. Access to other URLs is blocked.
- **Block** - Blocks access to web pages with URLs containing keywords that are in the selected keyword groups or objects. Access to other URLs is allowed.

Exception List - Specify the object profile(s) as the exception list which will be processed in an opposite manner to the action selected above.

Group/Object Selections - Shows the Keyword Groups and/or Objects selected for this URL Content Filter Profile.

To add or remove Keyword Groups and Objects to the selection, click the Edit button to bring up the following screen.

Object/Group Edit

<u>Keyword Object</u>	None ▾
or Keyword Object	None ▾
or Keyword Object	None ▾
or Keyword Object	None ▾
or Keyword Object	None ▾
or Keyword Object	None ▾
or Keyword Object	None ▾
or Keyword Object	None ▾
or <u>Keyword Group</u>	None ▾
or Keyword Group	None ▾
or Keyword Group	None ▾
or Keyword Group	None ▾
or Keyword Group	None ▾
or Keyword Group	None ▾
or Keyword Group	None ▾
or Keyword Group	None ▾
or Keyword Group	None ▾

OK Close

Up to 8 Keyword Objects and 8 Keyword Groups can be selected. To add, remove or modify Groups or Objects, click the Keyword Object or Keyword Group hyperlinks to bring up the **Objects Setting >> Keyword Object** or **Objects Setting >> Keyword Group** pages.

Web Feature

Enable Restrict Web Feature - Check to enable the web feature restriction.

Action - This setting is enabled only when Priority is set to Either: URL Access Control First or Either: Web Feature First.

- **Pass** - Allows access to web pages with URLs containing keywords that are in the selected keyword groups or objects. Access to other URLs is blocked.
- **Block** - Blocks access to web pages with URLs containing keywords that are in the selected keyword groups or objects. Access to other URLs is allowed.

File Extension Profile - Choose one of the profiles that you configured in **Object Setting>> File Extension Objects** previously for passing or blocking the file downloading.

	<p>Cookie - Select to block cookies from Internet websites.</p> <p>Proxy - Select to block web proxy servers that relay HTTP traffic.</p> <p>Upload - Select to block HTTP uploads from the LAN to the Internet.</p>
--	---

To save changes on the page, click **OK**. To discard changes, click **Cancel**. To clear all settings, click **Clear**.

IV-2-3 Web Content Filter Profile

Trial WCF service can be activated using the **Service Activation Wizard**.

If you wish to continue using WCF beyond the trial period, you can obtain a full WCF subscription by contacting your local DrayTek channel partner or dealer. WCF subscriptions can be activated using the **Activate** link on **CSM >> Web Content Filter Profile** (described in this section) or **System Maintenance**.

From the main menu, click **CSM**, followed by **Web Content Filter Profile** to load the profile configuration page.



Info 1

Web Content Filter (WCF) is not a built-in service of Vigor router but a service powered by Commtouch. If you want to use such service (trial or formal edition), you have to perform the procedure of activation first. For the service of formal edition, please contact with your dealer/distributor for detailed information.

Info 2

Commtouch is merged by Cyren, and GlobalView services will be continued to deliver powerful cloud-based information security solutions! Refer to: <http://www.prnewswire.com/news-releases/commtouch-is-now-cyren-239025151.html>

CSM >> Web Content Filter Profile



Web-Filter License

[Activate](#)

[Status: **License Expired**] [Provider: Cyren] [Start Date: 2020-10-20 Expire Date: 2020-11-19]

Setup Query Server	<input type="text" value="auto-selected"/>	Find more
Setup Test Server	<input type="text" value="auto-selected"/>	Find more

[Look up category by URL, or report inappropriate categorization.](#)

Web Content Filter Profile Table:

Cache : | [Set to Factory Default](#) |

Profile	Name	Profile	Name
1.	Default	5.	
2.		6.	
3.		7.	
4.		8.	

Note:

To make Web Content Filter profile effective, please go to **Firewall >> Filter Setup** page to create a firewall rule and select the desired profile.

Administration Message (Max 255 characters)

[Default Message](#)

```
<body><center><br><br><br><p>The requested Web page <br> from %SIP% <br>to %URL% <br>that is categorized with %CL% <br>has been blocked by %RNAME% Web Content Filter.<p>Please contact your system administrator for further information.</center></body>
```

Legend:

%SIP% - Source IP , %DIP% - Destination IP , %URL% - URL
%CL% - Category , %RNAME% - Router Name

OK

Available settings are explained as follows:

Item	Description
Activate	Click to visit the MyVigor website to activate WCF service. You will need to log in to your MyVigor account to proceed with the activation process. If you do not already have a MyVigor account, you can create one at this time.
Setup Query Server	Specify a WCF query server by typing address of the server. Click the Find more for a list of query servers. When the default value auto-selected is used, the server is determined automatically by looking up the geolocation of the WAN IP address. It is recommended that the default setting auto-selected be used.
Setup Test Server	Specify a WCF test server by typing address of the server. Click the Find more for a list of test servers. When the default value auto-selected is used, the server is determined automatically by looking up the geolocation of the WAN IP address. It is recommended that the default setting auto-selected be used.
Cache	None - The router verifies every HTTP URL requested by communicating with the WCF server on the Internet. This mode provides the most precise URL matching but has the lowest performance. L1 - The router caches the HTTP URLs that have been checked against the WCF server. URLs will be looked up in the L1 cache before reaching out to the WCF server. When the cache is full, the oldest entry will be deleted to accommodate new URLs. L2 - After a URL has been checked and found to pass WCF, the source and destination IPs are cached for about 1 second in the L2 cache. This is to allow a webpage to be loaded without further verifying the same URLs against the L1 cache or the WCF server. L1+L2 Cache - The router will utilize both L1 and L2 caches.
Set to Factory Default	Clear all profile settings.
Profile	Index number of the profile.
Name	Name that identifies the profile.
Administration Message	The message to be displayed in the browser when access to a website has been blocked. A custom message can be entered with HTML formatting in the text box. You can embed the following variables in the message: %SIP% - The source IP address that attempted the HTTP access. %DIP% - The destination IP address to which access was attempted. %URL% - The URL of the destination website. %CL% - The category to which the URL belongs. %RNAME% - The name of the router. Default Message - Click to reset the administration message to the factory default.

Up to 8 WCF profiles can be set up. To configure a profile, click its profile number to bring up its configuration page. Filter profile settings are specific to WCF providers. If you already have an active WCF subscription, activating a WCF subscription to a provider that is different from your current provider will clear all existing profile configuration.

C.SM >> Web Content Filter Profile

Profile Index: 1
 Profile Name: Log:

Black/White List

Enable

Action: URL keywords:

Action:

Security

Bot Nets DNS Over HTTPS Hacking
 Keyloggers and Monitoring Malware Sites Parked Domains
 Phishing and other Frauds Proxy Avoidance and Anonymizers SPAM URLs
 Spyware and Adware

Parental Control

Abortion Abused Drugs Adult and Pornography
 Alcohol and Tobacco Cheating Cult and Occult
 Gross Hate and Racism Illegal
 Low-THC Cannabis Products Marijuana Nudity
 Questionable Self Harm Sex Education
 Swimsuits and Intimate Apparel Violence Weapons

Productivity

Auctions Computer and Internet Info Content Delivery Networks
 Dating Gambling Games
 Home and Garden Hunting and Fishing Image and Video Search
 Individual Stock Advice and Tools Internet Communications Job Search
 Motor Vehicles Music Pay to Surf
 Peer to Peer Personal Storage Real Estate
 Shareware and Freeware Shopping Social Networking
 Sports Streaming Media Training and Tools
 Web Advertisements Web Hosting

General Use

Business and Economy Computer and Internet Security Dead sites

Available settings are explained as follows:

Item	Description
Profile Name	Name that identifies the WCF profile. The maximum length of the Profile Name is 15 characters.
Log	<p>Pass - Only passed access attempts will be recorded in Syslog.</p> <p>Block - Only blocked access attempts will be recorded in Syslog.</p> <p>All - Both passed and blocked access attempts will be recorded in Syslog.</p>
Black/White List	<p>Keyword objects and groups can be applied to the URL to override WCF category filtering.</p> <p>Enable - Select to enable blacklisting or whitelisting.</p> <p>Action - Action to take when a URL matches keyword group and object selections.</p> <ul style="list-style-type: none"> ● Pass - Allow access to the URL. ● Block - Disallow access to the URL. <p>URL Keywords - Displays selected keyword group and objects. Click the Edit button to modify keyword selections.</p>
Groups and Categories	<p>Select categories to be included in the filter.</p> <p>Action - Action to take when a URL matches keyword group and object selections.</p> <ul style="list-style-type: none"> ● Pass - allow access to the URL. ● Block - disallow access to the URL.

Select All - Click to select all categories within the group.
 Clear All - Click to deselect all categories within the group.

To save changes on the page, click OK. To discard changes, click Cancel.

IV-2-4 DNS Filter Profile

DNS Filter blocks or allows traffic to the WAN by intercepting DNS queries, and applying UCF and WCF rules to hostnames. DNS filtering is especially useful when you wish to restrict access of protocols other than HTTP, such as HTTPS. Note that a WCF license must have already been activated before WCF rules could be used.

To configure DNS Filter Profiles, select CSM >> Web Content Filter Profile from the main menu.

CSM >> DNS Filter

DNS Filter Profile Table

[Set to Factory Default](#)

Profile	Name	Profile	Name
1.		5.	
2.		6.	
3.		7.	
4.		8.	

Note:

To make DNS Filter profile effective, please go to [Firewall >> Filter Setup](#) page to create a firewall rule and select the desired profile.

DNS Filter Local Setting

DNS Filter	<input type="checkbox"/> Enable	
<u>Web Content Filter</u>	None	▼
<u>URL Content Filter</u>	None	▼
<u>Syslog</u>	None	▼
Black/White List	<input type="checkbox"/> Enable	Blacklist ▼
Address Type		Any Address ▼
Start IP Address		0.0.0.0
End IP Address		0.0.0.0
Subnet Mask		0.0.0.0
IP Group		None ▼
or IP Group		None ▼
or IP Object		None ▼
or IP Object		None ▼

Administration Message (Max 255 characters)

[Default Message](#)

```
<body><center><br><br><p><p>The requested Web page <br> from %SIP% <br>to %URL% <br>that is categorized with %CL% <br>has been blocked by %RNAME% DNS Filter.<p><p>Please contact your system administrator for further information.</center></body>
```

Legend:

%SIP% - Source IP , %URL% - URL
 %CL% - Category , %RNAME% - Router Name

OK

Cancel

Available settings are explained as follows:

Item	Description
DNS Filter Profile Table	<p>DNS Filter Profiles take effect when DNS servers on the WAN are used for DNS queries. The router intercepts all outgoing DNS queries on UDP port 53 and applies WCF and UCF rules on the domain names before passing the queries to the DNS servers. IP addresses of the domains are then blocked or allowed as per applicable WCF and UCF rules.</p> <p>DNS Filter Profiles can be applied by selecting from Firewall filter rules.</p> <p>Profile - Index number of the profile. Click to bring up the configuration page for the profile entry.</p> <p>Name - Name that identifies the profile.</p>
Set to Factory Default	Clear all DNS Filter profile settings.
DNS Filter Local Setting	<p>By setting the IP address of the DNS lookup server to the router's address, the router serves as a DNS lookup proxy server. When DNS Filter Local Setting is enabled, all DNS queries sent to the router will have WCF and UCF rules applied to the hostnames, and access to the resolved IP addresses will be allowed or blocked as configured in the rules.</p> <p>DNS Filter - Select to enable DNS Filter Local Setting.</p> <p>Web Content Filter - Select a WCF profile.</p> <p>URL Content Filter - Select a UCF profile.</p> <p>Syslog - The filtering result can be recorded according to the setting selected for Syslog.</p> <ul style="list-style-type: none"> ● None - No log file will be created for this profile. ● Pass - Only passed access attempts will be recorded in Syslog. ● Block - Only blocked access attempts will be recorded in Syslog. ● Both - Both passed and blocked access attempts will be recorded in Syslog. <p>Black/White List - Specify IP address, subnet mask, IP object, or IP group as a black list or white list for DNS packets passing through or blocked by Vigor router.</p>
Administration Message	<p>The message to be displayed in the browser when access to a website has been blocked. A custom message can be entered with HTML formatting in the text box.</p> <p>You can embed the following variables in the message:</p> <ul style="list-style-type: none"> ● %SIP% - The source IP address that attempted the HTTP access. ● %DIP% - The destination IP address to which access was attempted. ● %URL% - The URL of the destination website. ● %CL% - The category to which the URL belongs. ● %RNAME% - The name of the router. <p>Default Message - Click to reset the administration message to the factory default.</p>

To save changes on the page, click **OK**. To discard changes, click **Cancel**.

Application Notes

A-1 How to Create an Account for MyVigor

The website of MyVigor (a server located on <http://myvigor.draytek.com>) provides several useful services (such as Anti-Spam, Web Content Filter, Anti-Intrusion, and etc.) to filtering the web pages for the sake of protecting your system.

To access into MyVigor for getting more information, please create an account for MyVigor.

Create an Account via Vigor Router

1. Click CSM>> Web Content Filter Profile. The following page will appear.

CSM >> Web Content Filter Profile

Web-Filter License [Status: **Inactivated**] [Activate](#)

Setup Query Server: auto-selected [Find more](#)

Setup Test Server: auto-selected [Find more](#)

Web Content Filter Profile Table: Cache : L1 + L2 Cache | [Set to Factory Default](#)

Profile	Name	Profile	Name
1.	Default	5.	
2.		6.	
3.		7.	
4.		8.	

2. Click the Activate link. A login page for MyVigor web site will pop up automatically.

The MyVigor website does not record any personal identifiable information with the exception of your IP Address which is recorded after login for security purposes.

ENGLISH

DrayTek MyVigor

Username: carreni

Password: *****

Login

[Create Account / Get Help](#)

Copyright@DrayTek Corp Terms of Service / Privacy Policy

3. Click the link of Create an account now.
4. The system will ask if you are 16 years old or over.
 - If yes, click I am 16 or over.

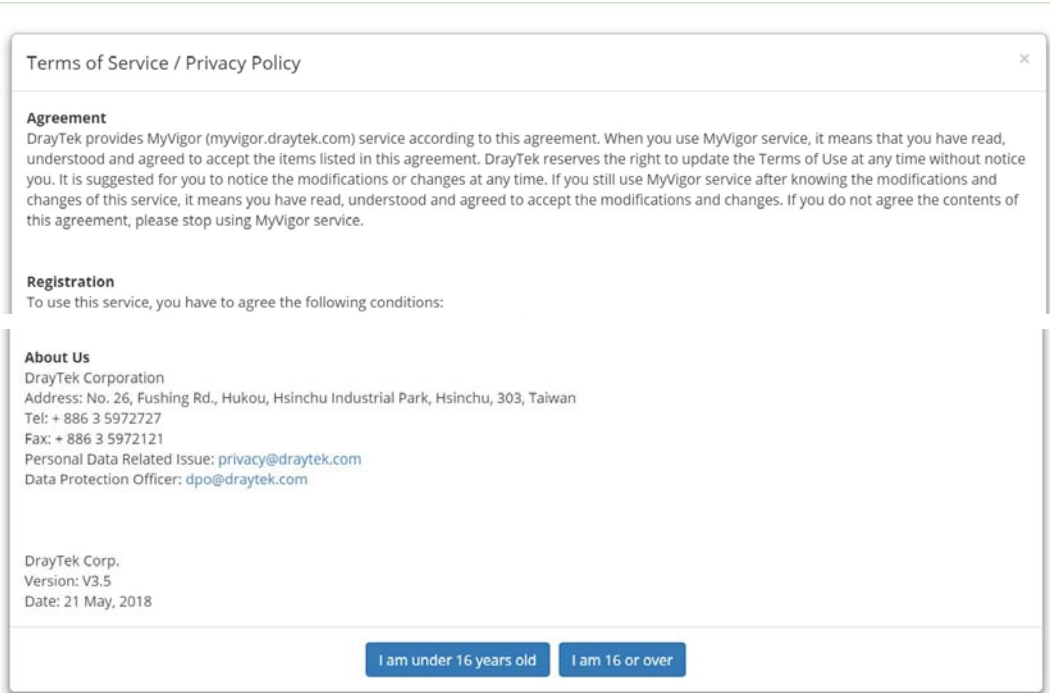

- If not, click **I am under 16 years old** to get the following page. Then, click **I and my legal guardian agree**.

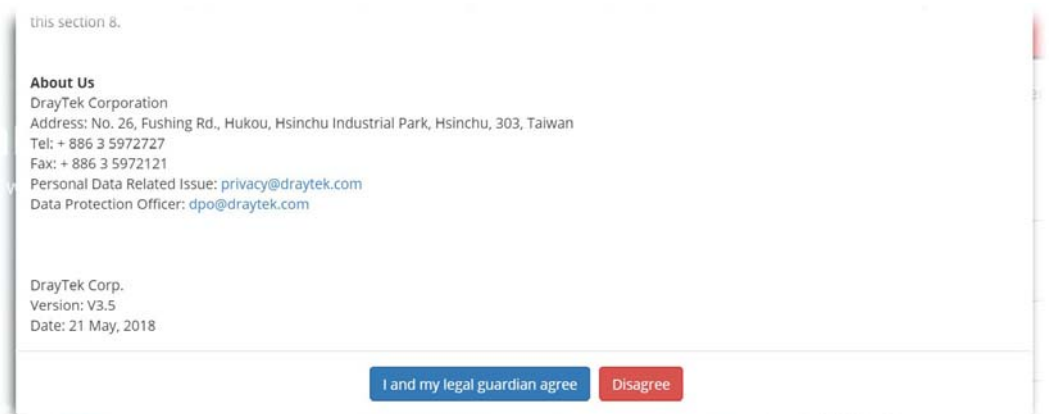

5. After reading the terms of service/privacy policy, click **Agree**.

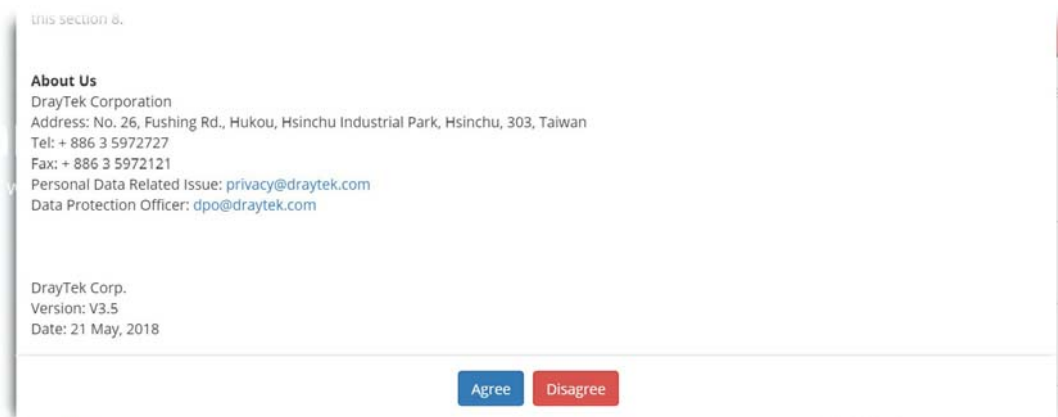

6. In the following page, enter your personal information in this page and then click **Continue**.

DrayTek MyVigor English

Create an account - Please enter personal profile.

UserName
Draytek_Document

Email Address
draytek@draytek.com

The user account (Draytek_Document)is available. Please complete registration to register this account.

Country
TAIWAN

Industry
Other

Password

Confirm Password

Do you agree to share your information to DrayTek office, regional distributor, local dealer and third party, in order to receive the newsletter or information from us?

Do you agree that MyVigor website can record your IP Address for security purposes?
Your IP Address record will only be used for the purposes of detecting and preventing malicious login attempts. You can change the setting or clear the record at anytime.

I'm not a robot reCAPTCHA Privacy - Terms

Continue

Return to Login

7. Choose proper selection for your computer and click **Continue**.

DrayTek MyVigor English

Thank you Draytek_Document, Your account has been created and an activation link has been sent to dr****k@draytek.com.

Note that you must activate the account by following the activation link in the email before you can login.

I'm not a robot reCAPTCHA Privacy - Terms

Resend the activation mail

Return to Login

8. Now you have created an account successfully.
9. Check to see the confirmation *email* with the title of **New Account Confirmation Letter** from **myvigor.draytek.com**.

***** This is an automated message from myvigor.draytek.com.*****

Thank you (**Mary**) for creating an account.

Please click on the activation link below to activate your account

Link : [Activate my Account](#)

10. Click the **Activate my Account** link to enable the account that you created. The following screen will be shown to verify the register process is finished. Please click **Login**.

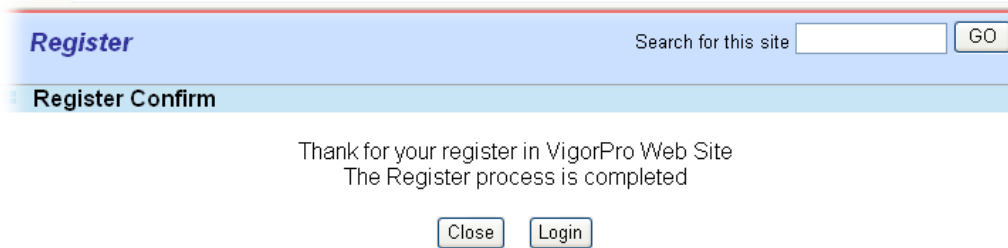

11. When you see the following page, please type in the account and password (that you just created) in the fields of **UserName** and **Password**.

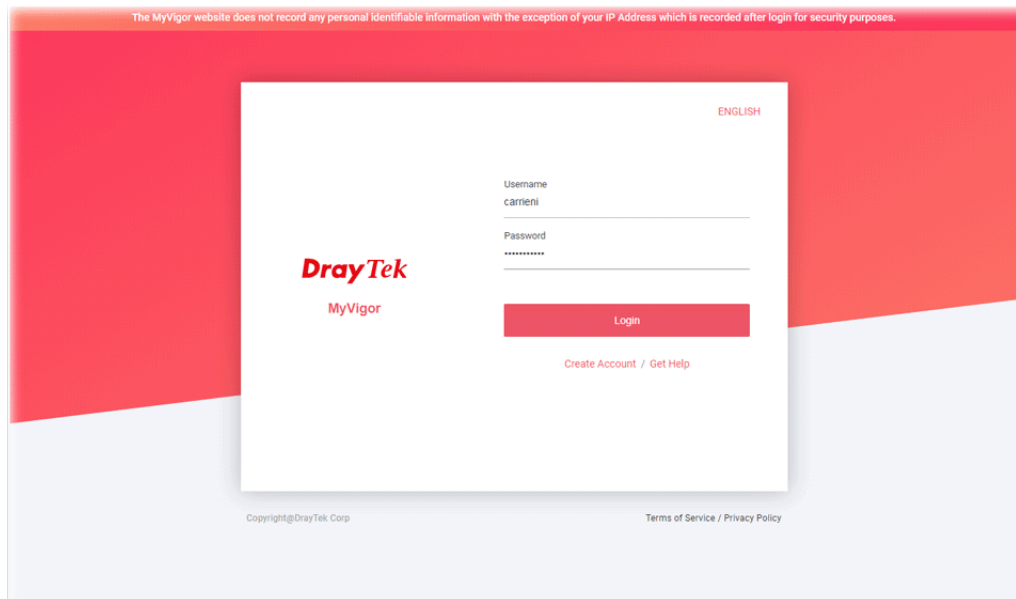

12. Now, click **Login**. Your account has been activated. You can access into MyVigor server to activate the service (e.g., WCF) that you want.

A-2 How to Block Facebook Service Accessed by the Users via Web Content Filter / URL Content Filter

There are two ways to block the facebook service, Web Content Filter and URL Content Filter.

Web Content Filter,

Benefits: Easily and quickly implement the category/website that you want to block.

Note: License is required.

URL Content Filter,

Benefits: Free, flexible for customize webpage.

Note: Manual setting (e.g., one keyword for one website.)

I. Via Web Content Filter

1. Make sure the Web Content Filter license is valid.
2. Open CSM >> **Web Content Filter Profile** to create a WCF profile. Check **Social Networking** with Action, **Block**.

The screenshot displays the configuration interface for the Web Content Filter. At the top, the 'Action' is set to 'Block'. The interface is organized into several sections: 'Groups' and 'Categories'. The 'Groups' section includes 'Child Protection', 'Leisure', 'Business', 'Chatting', and 'Computer-Internet', each with 'Select All' and 'Clear All' buttons. The 'Categories' section lists various content types with checkboxes. The 'Social Networking' category under the 'Computer-Internet' group is highlighted with a red box and is checked. Other checked categories include Alcohol & Tobacco, Criminal Activity, Gambling, Hate & Intolerance, Illegal Drug, Nudity, Porn & Sexually, Violence, Weapons, School Cheating, Sex Education, and Tasteless.

Groups	Categories
Child Protection Select All Clear All	<input checked="" type="checkbox"/> Alcohol & Tobacco <input checked="" type="checkbox"/> Criminal Activity <input checked="" type="checkbox"/> Gambling <input checked="" type="checkbox"/> Hate & Intolerance <input checked="" type="checkbox"/> Illegal Drug <input checked="" type="checkbox"/> Nudity <input checked="" type="checkbox"/> Porn & Sexually <input checked="" type="checkbox"/> Violence <input checked="" type="checkbox"/> Weapons <input checked="" type="checkbox"/> School Cheating <input checked="" type="checkbox"/> Sex Education <input checked="" type="checkbox"/> Tasteless <input checked="" type="checkbox"/> Child Abuse Images
Leisure Select All Clear All	<input type="checkbox"/> Entertainment <input type="checkbox"/> Games <input type="checkbox"/> Sports <input type="checkbox"/> Travel <input type="checkbox"/> Leisure & Recreation <input type="checkbox"/> Fashion & Beauty
Business Select All Clear All	<input type="checkbox"/> Business <input type="checkbox"/> Job Search <input type="checkbox"/> Web-based Mail
Chatting Select All Clear All	<input type="checkbox"/> Chat <input type="checkbox"/> Instant Messaging
Computer-Internet Select All Clear All	<input type="checkbox"/> Anonymizers <input type="checkbox"/> Forums & Newsgroups <input type="checkbox"/> Computers, Technology <input type="checkbox"/> Download Sites <input type="checkbox"/> Streaming, Downloads <input type="checkbox"/> Phishing & Fraud <input checked="" type="checkbox"/> Search Engine, Portals <input checked="" type="checkbox"/> Social Networking <input type="checkbox"/> Spam Sites <input type="checkbox"/> Malware <input type="checkbox"/> Botnets <input type="checkbox"/> Hacking

3. Select this profile in Firewall>>General Setup>>Default Rule.

Firewall >> General Setup

General Setup

General Setup	Default Rule	
Actions for default rule:		
Application	Action/Profile	Syslog
Filter	Pass	<input type="checkbox"/>
Sessions Control	0 / 150000	<input type="checkbox"/>
Quality of Service	None	<input type="checkbox"/>
User Management	None	<input type="checkbox"/>
APP Enforcement	None	<input type="checkbox"/>
URL Content Filter	None	<input type="checkbox"/>
Web Content Filter	None	<input type="checkbox"/>
DNS Filter	None	<input type="checkbox"/>
Advance Setting	[Create New] 1-Default Edit	

OK Cancel

4. Next time when someone accesses facebook via this router, the web page would be blocked and the following message would be displayed instead.

The requested Web page
from 192.168.2.114
to www.facebook.com/
that is categorized with [Social Networking]
has been blocked by Web Content Filter.

Please contact your system administrator for further information.

[Powered by DrayTek]

II. Via URL Content Filter

A. Block the web page containing the word of “Facebook”

1. Open Object Settings>>Keyword Object. Click an index number to open the setting page.
2. In the field of Contents, please type *facebook*. Configure the settings as the following figure.

Objects Setting >> Keyword Object Setup

Profile Index : 1

Name	Facebook
Contents	facebook

Limit of Contents: Max 3 Words and 63 Characters.
Each word should be separated by a single space.

You can replace a character with %HEX.
Example:
Contents: backdoo%72 virus keep%20out

Result:
1. backdoor
2. virus
3. keep out

OK Clear Cancel

3. Open CSM>>URL Content Filter Profile. Click an index number to open the setting page.
4. Configure the settings as the following figure.

CSM >> URL Content Filter Profile

Profile Index: 1

Profile Name: Facebook

Priority: Either : URL Access Control First Log: Block

URL Access Control

Enable URL Access Control Prevent web access from IP address

Action: Block Group/Object Selections: Facebook Edit

Exception List Edit

Web Feature

Enable Web Feature Restriction

Action: Pass File Extension Profile: None Cookie Proxy Upload

OK Clear Cancel

5. When you finished the above steps, click OK. Then, open Firewall>>General Setup.

- Click the **Default Rule** tab. Choose the profile just configured from the drop down list in the field of **URL Content Filter**. Now, users cannot open any web page with the word "facebook" inside.

Firewall >> General Setup

General Setup

General Setup **Default Rule**

Actions for default rule:

Application	Action/Profile	Syslog
Filter	Pass ▾	<input type="checkbox"/>
Sessions Control	0 / 60000	<input type="checkbox"/>
Quality of Service	None ▾	<input type="checkbox"/>
User Management	None ▾	<input type="checkbox"/>
APP Enforcement	None ▾	<input type="checkbox"/>
URL Content Filter	1-Facebook ▾	<input type="checkbox"/>
Web Content Filter	None ▾	<input type="checkbox"/>
DNS Filter	None ▾	<input type="checkbox"/>

Advance Setting

B. Disallow users to play games on Facebook

- Open **Object Settings>>Keyword Object**. Click an index number to open the setting page.
- In the field of **Contents**, please type *apps.facebook*. Configure the settings as the following figure.

Objects Setting >> Keyword Object Setup

Profile Index : 2

Name

Contents

Limit of Contents: Max 3 Words and 63 Characters.
Each word should be separated by a single space.

You can replace a character with %HEX.
Example:
Contents: backdoo%72 virus keep%20out

Result:
1. backdoor
2. virus
3. keep out

- Open CSM>>URL Content Filter Profile. Click an index number to open the setting page.
- Configure the settings as the following figure.

CSM >> URL Content Filter Profile

Profile Index: 2

Profile Name:

Priority: Log:

URL Access Control

Enable URL Access Control Prevent web access from IP address

Action:

Exception List

Web Feature

Enable Web Feature Restriction

Action: **File Extension Profile:** Cookie Proxy Upload

- When you finished the above steps, please open Firewall>>General Setup.
- Click the **Default Rule** tab. Choose the profile just configured from the drop down list in the field of URL Content Filter. Now, users cannot open any web page with the word "facebook" inside.

Firewall >> General Setup

General Setup

General Setup
Default Rule

Actions for default rule:	Action/Profile	Syslog
Application Filter	<input type="text" value="Pass"/>	<input type="checkbox"/>
Sessions Control	0 / <input type="text" value="60000"/>	<input type="checkbox"/>
Quality of Service	<input type="text" value="None"/>	<input type="checkbox"/>
User Management	<input type="text" value="None"/>	<input type="checkbox"/>
APP Enforcement	<input type="text" value="None"/>	<input type="checkbox"/>
URL Content Filter	<input type="text" value="2-face.apps"/>	<input type="checkbox"/>
Web Content Filter	<input type="text" value="None"/>	<input type="checkbox"/>
DNS Filter	<input type="text" value="None"/>	<input type="checkbox"/>

Advance Setting

A-3 How to use APP Enforcement to block application like Facebook, YouTube or TeamViewer?

APP Enforcement helps network administrator to block applications on LAN network. Draytek routers provide a few categories to set up the profiles e.g., IM, P2P, Protocol, Stream, Remote control.

This section is going to demonstrate how to use APP Enforcement to block Facebook, Skype, YouTube and TeamViewer.

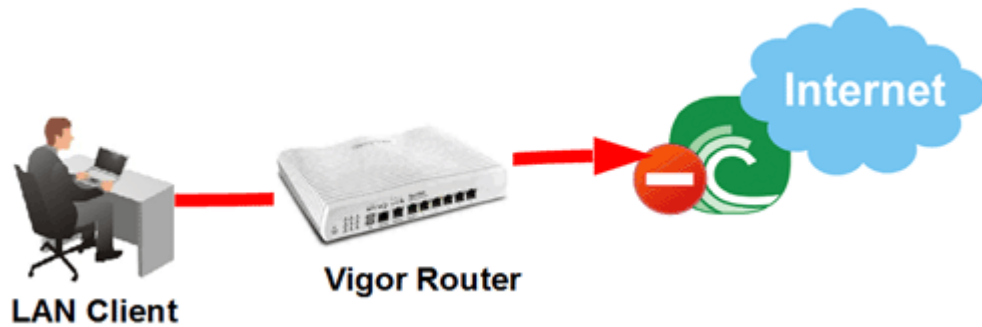

1. Create an APP Enforcement Profile: Click on an Index number to create a new profile at CSM >> APP Enforcement Profile.

CSM >> APP Enforcement Profile

APP Enforcement Profile Table:

Profile	Name	Profile	Name
<u>1.</u>		<u>17.</u>	
<u>2.</u>		<u>18.</u>	
<u>3.</u>		<u>19.</u>	
<u>4.</u>		<u>20.</u>	
<u>5.</u>		<u>21.</u>	

- Set up the details in the profile.

Profile Index : 1
 Profile Name:

Category	Application			
Instant Message <input type="button" value="Select All"/> <input type="button" value="Clear All"/>	<input type="checkbox"/> AIM	<input type="checkbox"/> AIM Login	<input type="checkbox"/> AliWW	
	<input type="checkbox"/> Ares	<input type="checkbox"/> BaiduHi	<input checked="" type="checkbox"/> Facebook b	
	<input type="checkbox"/> Fetion	<input type="checkbox"/> GaduGadu Protocol	<input type="checkbox"/> Google Hangouts	
	<input type="checkbox"/> ICQ	<input type="checkbox"/> iMessage	<input type="checkbox"/> iSpQ	
	<input type="checkbox"/> KC	<input type="checkbox"/> LINE	<input type="checkbox"/> Paltalk	
	<input type="checkbox"/> PocoCall	<input type="checkbox"/> Qnext	<input type="checkbox"/> Tencent QQ	
	<input type="checkbox"/> UC	<input type="checkbox"/> WebIM URLs	<input type="checkbox"/> WhatsApp	
	<input type="checkbox"/> Yahoo! Messenger			
	VoIP <input type="button" value="Select All"/> <input type="button" value="Clear All"/>	<input type="checkbox"/> RC Voice	<input checked="" type="checkbox"/> Skype c	<input type="checkbox"/> TeamSpeak
		<input type="checkbox"/> TelTel		
Stream <input type="button" value="Select All"/> <input type="button" value="Clear All"/>	<input type="checkbox"/> FlashVideo	<input type="checkbox"/> MMS protocol	<input type="checkbox"/> MySee	
	<input type="checkbox"/> PPStream	<input type="checkbox"/> PPTV	<input type="checkbox"/> QQLive	
	<input type="checkbox"/> QvodPlayer	<input type="checkbox"/> RTSP protocol	<input type="checkbox"/> SilverLight	
	<input type="checkbox"/> Slingbox	<input type="checkbox"/> SopCast	<input type="checkbox"/> TVUPlayer	
	<input type="checkbox"/> UUSEE 2008	<input checked="" type="checkbox"/> YouTube d		
Remote Control <input type="button" value="Select All"/> <input type="button" value="Clear All"/>	<input type="checkbox"/> Ammy Admin	<input type="checkbox"/> LogMeIn Pro2	<input type="checkbox"/> Radmin	
	<input type="checkbox"/> ShowMyPC	<input type="checkbox"/> SpyAnywhere	<input checked="" type="checkbox"/> TeamViewer e	
	<input type="checkbox"/> Timbuku	<input type="checkbox"/> VNC protocol	<input type="checkbox"/> Windows Live Sync	
	<input type="checkbox"/> WindowsRDP			
Web HD <input type="button" value="Select All"/> <input type="button" value="Clear All"/>	<input type="checkbox"/> ADrive	<input type="checkbox"/> Box	<input type="checkbox"/> Dropbox	
	<input type="checkbox"/> Google Service	<input type="checkbox"/> HTTP Upload	<input type="checkbox"/> iCloud	
	<input type="checkbox"/> Microsoft Office Live	<input type="checkbox"/> Microsoft OneDrive	<input type="checkbox"/> Mozy	

- Enter Profile Name.
- Choose the Facebook in Instant Message.
- Choose Skype in VoIP.
- Choose YouTube in Stream.
- Choose TeamViewer in Remote control.
- Click OK to save.

- Apply the APP Enforcement Profile to a Firewall Filter Rule. Go to Firewall >> Filter Setup, and click an available set.

Firewall >> Filter Setup ?

Filter Setup | [Set to Factory Default](#) |

Set	Comments	Set	Comments
1.	Default Call Filter	7.	
2.	Default Data Filter	8.	
3.		9.	
4.		10.	
5.		11.	
6.		12.	

- Click on a Filter Rule index to set up a filter.

Firewall >> Filter Setup >> Edit Filter Set

Filter Set 2
Comments : Default Data Filter

Rule	Enable	Comments	Direction	Src IP	Dst IP	Service Type	Action	CSM	Move Up	Move Down
1	<input checked="" type="checkbox"/>	xNetBios -> DNS	LAN/DMZ/RT/VPN -> WAN	Any	Any	TCP/UDP, Port: from 137~139 to 53	Block Immediately			Down
2	<input type="checkbox"/>		LAN/DMZ/RT/VPN -> WAN	Any	Any	Any	Pass Immediately		UP	Down
3	<input type="checkbox"/>		LAN/DMZ/RT/VPN -> WAN	Any	Any	Any	Pass Immediately		UP	Down
4	<input type="checkbox"/>		LAN/DMZ/RT/VPN -> WAN	Any	Any	Any	Pass Immediately		UP	Down
5	<input type="checkbox"/>		LAN/DMZ/RT/VPN -> WAN	Any	Any	Any	Pass Immediately		UP	Down
6	<input type="checkbox"/>		LAN/DMZ/RT/VPN -> WAN	Any	Any	Any	Pass Immediately		UP	Down
7	<input type="checkbox"/>		LAN/DMZ/RT/VPN -> WAN	Any	Any	Any	Pass Immediately		UP	

Filter Set 1 2 3 4 5 6 7 8 9 10 11 12 Next Filter Set None

Wizard Mode: most frequently used settings in three pages
 Advance Mode: all settings in one page

- Set up the details in the profile.

Firewall >> Edit Filter Set >> Edit Filter Rule

Filter Set 2 Rule 2

Enable **a**

Comments: Block_by_APPE **b**

Schedule Profile: None, None, None, None

Clear sessions when schedule is ON

Direction: LAN/DMZ/RT/VPN -> WAN **c** Advanced

Source IP/Country: Any Edit **d**

Destination IP/Country: Any Edit

Service Type: Any Edit

Fragments: Don't Care

Application Filter	Action/Profile: Pass Immediately	Syslog: <input type="checkbox"/>
Branch to Other Filter Set	None	<input type="checkbox"/>
Sessions Control	0 / 50000	<input type="checkbox"/>
MAC Bind IP	Non-Strict	<input type="checkbox"/>
<u>Quality of Service</u>	None	<input type="checkbox"/>
<u>User Management</u>	None	<input type="checkbox"/>
<u>APP Enforcement</u>	1-Block f	<input checked="" type="checkbox"/> g
<u>URL Content Filter</u>	None	<input type="checkbox"/>
<u>Web Content Filter</u>	None	<input type="checkbox"/>
<u>DNS Filter</u>	None	<input type="checkbox"/>

Advance Setting Edit

h OK Clear Cancel

- Enable the Filter Rule.
- Put the comments of this rule.
- Select the Direction as LAN/DMZ/RT/VPN -> WAN.
- Edit the Source IP which should be blocked from the APP.
- Select Filter as Pass Immediately.
- Select APP Enforcement as the profile we created in Step 2.
- You may also check the Syslog if needed.

- (h) Click **OK** to save.
6. With the above configuration, LAN clients cannot be able to use the APP and website.



This site can't provide a secure connection

www.facebook.com sent an invalid response.

[Try running Windows Network Diagnostics.](#)

ERR_SSL_PROTOCOL_ERROR

Part V Management



System
Maintenance



Bandwidth
Management



User
Management

There are several items offered for the Vigor router system setup: System Status, TR-069, Administrator Password, User Password, Login Page Greeting, Configuration Backup, Configuration Export, Syslog /Mail Alert, Time and Date, SNMP, Management, Self-Signed Certificate, Reboot System, Firmware Upgrade, Activation, Internal Service User List, Dashboard Control and NAT Sessions

It is used to control the bandwidth of data transmission through configuration of Sessions Limit, Bandwidth Limit, and Quality of Service (QoS).

It is a security feature which disallows any IP traffic (except DHCP-related packets) from a particular host until that host has correctly supplied a valid username and password.

V-1 System Maintenance

For the system setup, there are several items that you have to know the way of configuration: System Status, TR-069, Administrator Password, User Password, Login Page Greeting, Configuration Backup, Syslog /Mail Alert, Time and Date, Management, Panel Control, Reboot System, Firmware Upgrade, Internal Service User List, Dashboard Control and NAT Sessions.

Below shows the menu items for System Maintenance.

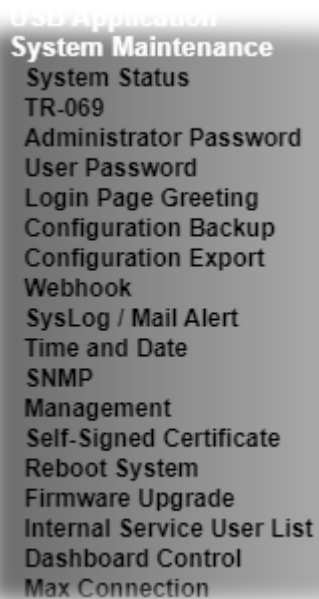

The image shows a screenshot of a web application menu. The menu is titled "System Maintenance" and lists the following items: System Status, TR-069, Administrator Password, User Password, Login Page Greeting, Configuration Backup, Configuration Export, Webhook, SysLog / Mail Alert, Time and Date, SNMP, Management, Self-Signed Certificate, Reboot System, Firmware Upgrade, Internal Service User List, Dashboard Control, and Max Connection. The menu is displayed in a dark grey box with white text.

- System Maintenance
 - System Status
 - TR-069
 - Administrator Password
 - User Password
 - Login Page Greeting
 - Configuration Backup
 - Configuration Export
 - Webhook
 - SysLog / Mail Alert
 - Time and Date
 - SNMP
 - Management
 - Self-Signed Certificate
 - Reboot System
 - Firmware Upgrade
 - Internal Service User List
 - Dashboard Control
 - Max Connection

Web User Interface

V-1-1 System Status

The System Status displays basic network information of Vigor router including LAN and WAN interface status. Also available is the current firmware version and firmware related information.

System Maintenance >> System Status

Model Name : Vigor3912
Firmware Version : 4.3.5
Build Date/Time : Nov 13 2023 16:38:20

LAN					
	MAC Address	IP Address	Subnet Mask	DHCP Server	DNS
LAN1	14-49-BC-34-9B-88	192.168.1.1	255.255.255.0	ON	8.8.8.8
IP Routed Subnet	14-49-BC-34-9B-88	192.168.0.1	255.255.255.0	ON	8.8.8.8

WAN					
	Link Status	MAC Address	Connection	IP Address	Default Gateway
WAN1	Disconnected	14-49-BC-34-9B-89	DHCP Client	---	---
WAN3	Disconnected	14-49-BC-34-9B-8B	DHCP Client	---	---
WAN5	Disconnected	14-49-BC-34-9B-8D	DHCP Client	---	---
WAN6	Disconnected	14-49-BC-34-9B-8E	DHCP Client	---	---
WAN7	Disconnected	14-49-BC-34-9B-8F	DHCP Client	---	---
WAN8	Disconnected	14-49-BC-34-9B-90	DHCP Client	---	---

IPv6			
	Address	Scope	Internet Access Mode
LAN	FE80::DFCD:FF2D:8C22:AC20/64	Link	---

User Mode is **OFF** now.

Available settings are explained as follows:

Item	Description
Model Name	Displays the model name of the router.
Firmware Version	Displays the firmware version of the router.
Build Date/Time	Displays the date and time of the current firmware build.
LAN	MAC Address - Displays the MAC address of the LAN Interface. IP Address - Displays the IP address of the LAN interface. Subnet Mask - Displays the subnet mask address of the LAN interface. DHCP Server - Displays the current status of DHCP server of the LAN interface. DNS - Displays the assigned IP address of the primary DNS.
WAN	Link Status - Displays current connection status of the WAN interface.

	<p>MAC Address - Displays the MAC address of the WAN Interface.</p> <p>Connection - Displays the connection type of the WAN interface..</p> <p>IP Address - Displays the IP address of the WAN interface.</p> <p>Default Gateway - Displays the assigned IP address of the default gateway.</p>
IPv6	<p>Address - Displays the IPv6 address for LAN.</p> <p>Scope - Displays the scope of IPv6 address. For example, IPv6 Link Local is non-routable and can only be used for local connections.</p> <p>Internet Access Mode - Displays the connection mode of the WAN interface.</p>

V-1-2 TR-069

This device supports the TR-069 standard for remote management of customer-premises equipment (CPE) through an Auto Configuration Server, such as VigorACS.

V-1-2-1 ACS and CPE Settings



ACS and CPE Settings	Reporting Configuration	Export Parameters
<p>TR-069 <input checked="" type="radio"/> Disable <input type="radio"/> Enable</p> <p>ACS Server On <input type="text" value="Internet"/></p> <p><input checked="" type="checkbox"/> Enable TR069 Server on System Maintenance >> Management >> Internet Access Control</p> <p>Note: For LAN interface ,only support LAN1 ~ LAN16.</p> <hr/> <p>ACS Server</p> <p>URL <input type="text"/> <input type="button" value="Wizard"/></p> <p><input type="checkbox"/> Acquire URL from DHCP option 43</p> <p>Username <input type="text" value="Max: 31 characters"/></p> <p>Password <input type="text" value="Max: 31 characters"/></p> <p><input type="button" value="Test With Inform"/> Event Code <input type="text" value="PERIODIC"/></p> <p>Last Inform Response Time: (NA) ●</p> <hr/> <p>CPE Client</p> <p>Protocol <input checked="" type="radio"/> HTTP <input type="radio"/> HTTPS</p> <p>URL <input type="text"/></p> <p>Port <input type="text" value="8069"/></p> <p>Username <input type="text" value="vigor"/></p> <p>Password <input type="text" value="*****"/></p>		
<p>Periodic Inform Settings</p> <p><input type="radio"/> Enable <input checked="" type="radio"/> Disable</p> <p>Time Interval <input type="text" value="900"/> second(s)</p>		
<p>STUN Settings</p> <p><input type="radio"/> Enable <input checked="" type="radio"/> Disable</p> <p>Server Address <input type="text"/></p> <p>Server STUN Port <input type="text" value="3478"/></p> <p>Minimum Keep Alive Period <input type="text" value="60"/> second(s)</p> <p>Maximum Keep Alive Period <input type="text" value="-1"/> second(s)</p>		
<p>Apply Settings to APs/Switches</p> <p><input type="radio"/> Enable <input checked="" type="radio"/> Disable</p> <p>AP/Switches Password <input type="text"/></p> <p><input type="checkbox"/> Specify STUN Settings for APs/Switches</p> <p><input type="radio"/> Enable <input checked="" type="radio"/> Disable</p> <p>Server Address <input type="text"/></p> <p>Server Port <input type="text" value="3478"/></p> <p>Minimum Keep Alive Period <input type="text" value="60"/> second(s)</p> <p>Maximum Keep Alive Period <input type="text" value="-1"/> second(s)</p>		
<p><input type="button" value="OK"/> <input type="button" value="Clear"/></p>		

Available settings are explained as follows:

Item	Description
TR-069	Enables or disables TR-069 functionality.
ACS Server On	Choose the interface for connecting the router to the Auto

	<p>Configuration Server.</p> <p>Enable TR069 Server on....- If enabled, a user will be allowed to access into TR-069 from WAN.</p> <p>If the TR-069 Server not enabled, VigorACS can not manage the Vigor router remotely.</p>
ACS Server	<p>This section specifies the settings of the ACS Server.</p> <p>URL - Enter the URL for connecting to the ACS. Please refer to the Auto Configuration Server user's manual for detailed information.</p> <ul style="list-style-type: none"> ● Wizard - Click it to enter the IP address of VigorACS server, port number and the handler. ● Acquire URL from DHCP option 43 - Select to acquire the ACS URL from DHCP option 43. <p>Username/Password - Enter the credentials required to connect to the ACS server.</p> <ul style="list-style-type: none"> ● Test With Inform - Click to send an inform message using the selected Event Code to test if the CPE is able to communicate with the VigorACS server. ● Event Code - Select an event for the inform test. <p>Last Inform Response Time - Displays the time of the most recent Inform Response message received from the VigorACS.</p>
CPE Client	<p>This section specifies the settings of the CPE Client.</p> <p>Http / Https - Select Https if the connection is encrypted; otherwise select Http.</p> <p>Port - In the event of port conflicts, change the port number of the CPE.</p> <p>Username and Password - Enter the username and password that the VigorACS will use to connect to the CPE.</p>
Periodic Inform Settings	<p>Enable - The default setting is Enable, which means the CPE Client will periodically connect to the ACS Server to update its connection parameters at intervals specified in the Interval Time field.</p> <ul style="list-style-type: none"> ● Time Interval - Set interval time or schedule time for the router to send notification to CPE. <p>Disable - Select Disable to turn off periodic notifications.</p>
STUN Settings	<p>STUN allows the ACS Server to connect to the CPE Client even when the client is behind a network address translator (NAT).</p> <p>Disable - The default setting is Disable.</p> <p>Enable - Please Enter the relational settings listed below:</p> <ul style="list-style-type: none"> ● Server Address - Enter the IP address of the STUN server. ● Server STUN Port - Enter the port number of the STUN server. ● Minimum Keep Alive Period - If STUN is enabled, the CPE must periodically transmit binding requests to the server for the purpose of maintaining the binding with the Gateway. Enter the minimum interval between keep-alive messages that the CPE client sends to the ACS server. The default setting is 60 seconds. ● Maximum Keep Alive Period - If STUN is enabled, the CPE must send binding request to the server for the

	<p>purpose of maintaining the binding with the Gateway. Enter the maximum interval between keep-alive messages that the CPE client sends to the ACS server. A value of -1 indicates that no maximum period is specified.</p>
<p>Apply Settings to APs/Switches</p>	<p>This feature is able to apply TR-069 settings (including STUN and ACS server settings) to all of APs managed by Vigor router at the same time.</p> <p>Disable - TR-069 and Related settings will not be applied to VigorAPs.</p> <p>Enable - TR-069 settings will be applied to VigorAPs after clicking OK. The VigorAP password must be specified.</p> <ul style="list-style-type: none"> ● AP/Switches Password - Enter the password of the VigorAP that you want to apply Vigor router's TR-069 settings. ● Specify STUN Settings for APs/Switches - After clicking the Enable radio button for Apply Settings to APs, if you want to apply specific STUN settings (i.e., different from the Vigor2865 STUN settings) to VigorAPs to meet specific requirements, check this box and enter the server IP address, server port, and minimum and maximum keep alive periods respectively.

Select OK to save changes on the page, or Clear to reset all settings to factory defaults.

V-1-2-2 Reporting Configuration

Information related to the router's health are divided into several categories and listed in this field. After checking the item(s), Vigor router will arrange and send corresponding data to VigorACS as a reference for the system administrator.

ACS and CPE Settings	Reporting Configuration	Export Parameters
Health Parameters		
<input type="checkbox"/> CPU Usage	<input type="checkbox"/> IP/Subnet Conflict	
<input type="checkbox"/> Memory Usage		
<input type="checkbox"/> WAN Bandwidth Usage		
<input type="checkbox"/> WAN Ping to Keep Alive Status	<input type="checkbox"/> DDoS Status	
<input type="checkbox"/> ARP Table Status	<input type="checkbox"/> VPN Connection Status	
<input type="checkbox"/> Routing Table Status	<input type="checkbox"/> Session Usage	
<input type="checkbox"/> Login Attempts		
Threshold		
<input type="checkbox"/> VoIP R-Factor	Warning <input type="text" value="60"/> %	Critical <input type="text" value="40"/> % (0~100)
CPE Notification Settings		
<input checked="" type="checkbox"/> Enable		
<input type="checkbox"/> Web Login		
<input type="checkbox"/> Web Configuration		
<input type="checkbox"/> High Availability		
<input checked="" type="checkbox"/> Bandwidth Utilization		
Time Period <input type="text" value="15 mins"/>		
Note: Please turn off Hardware Acceleration in the router to receive Alerts Notifications, and accuracy of Bandwidth data.		
WAN	Threshold	Line
	Level	Speed
<input type="checkbox"/> WAN1	Medium <input type="text" value="0"/> % High <input type="text" value="0"/> %	of TX: <input type="text" value="0"/> Mbps RX: <input type="text" value="0"/> Mbps
<input type="checkbox"/> WAN3	Medium <input type="text" value="0"/> % High <input type="text" value="0"/> %	of TX: <input type="text" value="0"/> Mbps RX: <input type="text" value="0"/> Mbps
<input type="checkbox"/> WAN5	Medium <input type="text" value="0"/> % High <input type="text" value="0"/> %	of TX: <input type="text" value="0"/> Mbps RX: <input type="text" value="0"/> Mbps
<input type="checkbox"/> WAN6	Medium <input type="text" value="0"/> % High <input type="text" value="0"/> %	of TX: <input type="text" value="0"/> Mbps RX: <input type="text" value="0"/> Mbps
<input type="checkbox"/> WAN7	Medium <input type="text" value="0"/> % High <input type="text" value="0"/> %	of TX: <input type="text" value="0"/> Mbps RX: <input type="text" value="0"/> Mbps
<input type="checkbox"/> WAN8	Medium <input type="text" value="0"/> % High <input type="text" value="0"/> %	of TX: <input type="text" value="0"/> Mbps RX: <input type="text" value="0"/> Mbps

OK

Available settings are explained as follows:

Item	Description
Health Parameters	Check the one that Vigor router will send the status information to VigorACS. Threshold (for VoIP R-Factor) - Once the quality of VoIP is lower than warning limit value or critical limit value, the router will send the result to VigorACS.
CPE Notification Settings	Enable - Check the box to select the notification item(s). Vigor router will send the utilization status to VigorACS.

Click OK to save changes on the page.

V-1-2-3 Export Parameters

Click Export to save the TR-069 parameter settings as an ".xml".

ACS and CPE Settings

Reporting Configuration

Export Parameters

Export

Export tr069 parameters by xml.

V-1-3 Administrator Password

This page allows you to set or change the administrator password.

System Maintenance >> Administrator Password

Administrator Password

Old Password	<input type="text" value="Max: 83 characters"/>	
New Password	<input type="text" value="Max: 83 characters"/>	
Confirm Password	<input type="text" value="Max: 83 characters"/>	
Password Strength:	<input type="button" value="Weak"/> <input type="button" value="Medium"/> <input type="button" value="Strong"/>	
Strong password requirements:		
1. Have at least one upper-case letter and one lower-case letter.		
2. Including non-alphanumeric characters is a plus.		
<input checked="" type="checkbox"/> Enable 'admin' account login to Web UI from the Internet		
<input type="checkbox"/> Enable Advanced Authentication method when login from "WAN"		
<input checked="" type="radio"/> Mobile one-Time Passwords(mOTP)		
PIN Code	<input type="text" value="*****"/>	Secret <input type="text" value="*****"/>
<input type="radio"/> 2-Step Authentication		
Send Auth code via		
<input type="checkbox"/> SMS Profile	<input type="text" value="1 - ???"/>	Recipient Number <input type="text"/>
<input type="checkbox"/> Mail Profile	<input type="text" value="1 - ???"/>	Mail Address <input type="text"/>

Note:

Password can contain only a-z A-Z 0-9 , ; : . " < > * + = - \ | ? @ # ^ ! ()

Administrator Local User

<input type="checkbox"/> Enable Local User	
Specific User	
User Name	<input type="text" value="Max: 15 characters"/>
Password	<input type="text" value="Max: 15 characters"/>
Confirm Password	<input type="text" value="Max: 15 characters"/>

Available settings are explained as follows:

Item	Description
Administrator Password	<p>The administrator can login web user interface of Vigor router to modify all of the settings to fit the requirements.</p> <p>Old Password - Enter the current password. The factory default is "admin".</p> <p>New Password - Enter the new password. The maximum length of the password is 23 characters.</p> <p>Confirm Password - Enter the new password again for confirmation.</p> <p>Password Strength - Shows the security strength of the password specified above.</p> <p>Enable 'admin' account login to Web UI from the Internet - Select to allow the administrator to log in from the Internet. This option is enabled when Administrator Local User is enabled (see below).</p> <p>Use only advanced authentication method for Admin</p>

	<p>“WAN” login - Advanced authentication method can offer a more secure network connection. Select to require mOTP or 2-step authentication when logging in from the WAN.</p> <ul style="list-style-type: none"> ● Mobile one-Time Password (mOTP) - Select to allow the use of mOTP passwords. Enter the PIN Code and Secret settings for getting one-time passwords. ● 2-Step Auth code via <u>SMS Profile</u> and/or <u>Mail Profile</u> - Select the SMS and/or Mail profiles and the destination SMS number and/or email address for transmitting the password.
<p>Administrator Local User</p>	<p>Usually, the system administrator has the highest privilege to modify the settings on the web user interface of the Vigor router. However, in some cases, it might be necessary to have other users in LAN to access into the web user interface of Vigor router.</p> <p>This feature allows you to add more administrators who can then log in to the web interface, with the same privileges as the administrator.</p> <p>Enable Local User - Check the box to allow other users to administer the router.</p> <p>Specific User - Create the new user account as the local user. Then specify the authentication method (dividing into Basic and Advanced) for the user account.</p> <ul style="list-style-type: none"> ● User Name - Enter a user name. ● Password - Enter the password for the local user. ● Confirm Password - Enter the new password again for confirmation. ● User Name and Password only - If selected, you need to enter a user name and password. ● Mobile one-Time Password (mOTP) - Select to allow the use of mOTP passwords. Enter the mOTP PIN Code and Secret that will be used to generate the one-time passwords. ● 2-Step Authentication via <u>SMS Profile</u> and/or <u>Mail Profile</u> - Select the SMS and/or Mail profiles and the destination SMS number and/or email address for transmitting the password. ● Enable Advanced Authentication method when login from “WAN” - Advanced authentication method can offer a more secure network connection. Select to require mOTP or 2-step authentication when logging in from the WAN. ● Add - After entering the user name and password above, click this button to create a new local user. The new user will be shown on the Local User List immediately. ● Edit - If you wish to change a user in the Local User List, select it, perform the necessary modifications, and click this button to update the user. ● Delete - If you wish to delete a user in the Local User List, select it and click this button to remove it. ● Local User List - Shows all the users that are set up to administer the router.
<p>Administrator LDAP Setting</p>	<p>Enable LDAP/AD login for admin users - Select to allow authentication using an LDAP/Active Directory Server.</p> <p>LDAP Server Profiles Setup - Click to set up the LDAP/Active</p>

	Directory server.
Administrator TACACS+ Setting	Enable TACACS+ login for admin users - If it is enabled, any user can access into the web user interface of Vigor router through the TACACS+ server authentication. <ul style="list-style-type: none">● Fallback to local Authentication - If it is enabled, the administrator can use other login methods for authentication once the TACACS+ server has no response.

Click **OK** to save changes on the page, and you will be directed to the login screen. Please log in with the new password.

V-1-4 User Password

This page allows you to set new password for user operation.

System Maintenance >> User Password

Enable User Mode for simple web configuration

User Password

| [Set to Factory Default](#) |

Password	Max: 83 characters
Confirm Password	Max: 83 characters
Password Strength:	<input type="button" value="Weak"/> <input type="button" value="Medium"/> <input type="button" value="Strong"/>
Strong password requirements:	
1. Have at least one upper-case letter and one lower-case letter.	
2. Including non-alphanumeric characters is a plus.	

Note:

1. Password can contain a-z A-Z 0-9 , ; : . " < > * + = | ? @ # ^ ! ()
2. Password can't be all asterisks(*). For example, '*' or '*****' is illegal, but '123*' or '*45' is OK.

Available settings are explained as follows:

Item	Description
Enable User Mode for simple web configuration	Check this box to enable User Mode for web user interface with the password typed here for simple web configuration. The simple web user interface settings differ from those on the full web user interface seen when logged in using the administrator password.
Password	Enter the password.
Confirm Password	Enter the password again for verification.
Password Strength	Shows the security strength of the password specified above.
Set to Factory Default	Click to return to the factory default setting.

Click OK to save changes on the page, and you will be directed to the login screen. Please window will appear. Please log in with the new password.

Here are the steps involved in setting up the router for User Mode Access:

1. Navigate to **System Maintenance>>User Password** in the web user interface.
2. Check the box of **Enable User Mode for simple web configuration** to enable user mode operation. Enter a new password in the field of New Password and click **OK**.

System Maintenance >> User Password

Enable User Mode for simple web configuration

User Password

[Set to Factory Default](#)

Password	*****
Confirm Password	*****
Password Strength:	Weak Medium Strong
Strong password requirements:	
1. Have at least one upper-case letter and one lower-case letter.	
2. Including non-alphanumeric characters is a plus.	

Note:

1. Password can contain a-z A-Z 0-9 , ; : . " < > * + = | ? @ # ^ ! ()
2. Password can't be all asterisks(*). For example, '*' or '*****' is illegal, but '123*' or '*45' is OK.

OK

3. The following screen will appear. Simply click OK.

System Maintenance >> User Password

Active Configuration

Password	: *****
----------	---------

4. Log out the Vigor router web user interface by clicking the Logout button.

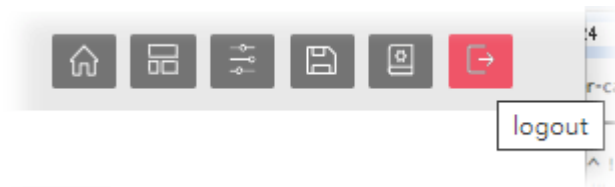

5. The following window will be shown. Enter the new user password in the Password field and click Login.

A screenshot of the DrayTek Vigor3912 login page. The page features the DrayTek logo and 'Vigor3912' text on the left. On the right, there is a login form with the following fields: 'Username' (admin), 'Password' (masked with dots), and 'Language' (English). A red 'Login' button is located below the form. At the bottom of the page, there is a copyright notice: 'Copyright © 2023 DrayTek Corp'.

6. The main screen with User Mode will be shown with less menu items.

Only basic settings are available in User Mode. These are a subset of the Admin Mode settings.



Info

Setting in User Mode can be configured as same as in Admin Mode.

V-1-5 Login Page Greeting

When you want to access into the web user interface of Vigor router, the system will ask you to offer username and password first. At that moment, the background of the web page is blank and no heading will be displayed on the Login window. This page allows you to specify login URL and the heading on the Login window if you have such requirement.

This section allows you to customize the login page by adding a message and/or setting the page title.

System Maintenance >> Login Page Greeting

Login Page Greeting

Login Page Logo: Default 未選擇任何檔案 (Max 524 × 352 pixel)

Enable Greeting

Login Page Title

Welcome Message and Bulletin (Max 511 characters) [Preview](#) [Set to Factory Default](#)

```
<h1><b><font color=red>Welcome Message</font></b></h1><p>This welcome message is displayed in the Login page of the router. Replace this text with your own message. </p><ol><li>The welcome message can be written in HTML so lists such as this one can be created </li><li>Other markup tags such as p, font or img can be used</li></ol>
```

Examples of Welcome Message and Bulletin:
 <h1>Welcome Message</h1>
 <p>Message</p>

Available settings are explained as follows:

Item	Description
Login Page Logo	Set an image which will be shown above the log in window. Default - The Enable Greeting feature is available to set the login page title. Blank - No image / no greeting. Upload a file - Choose an image file and click Upload . Later the selected image will be shown on the log in window.
Enable Greeting	Check this box to enable the login customization function.
Login Page Title	Enter a brief description (e.g., Welcome to DrayTek) which will be shown on the heading of the login dialog.
Welcome Message and Bulletin	Enter words or sentences here. It will be displayed for bulletin message. In addition, it can be displayed on the login dialog at the bottom. Note that do not enter URL redirect link here.
Preview	Click to preview the customized login window based on the settings entered on this page.
Set to Factory Default	Click to return to the factory default setting.

Below shows an example of a customized login page with the values entered in the **Login Page Title** and **Welcome Message and Bulletin** fields.

DrayTek

Vigor3912

Username

admin

Password

.....

Language

English

Login

Just for Carrie

Welcome Message

This welcome message is displayed in the Login page of the router. Replace this text with your own message.

1. The welcome message can be written in HTML so lists such as this one can be created
2. Other markup tags such as p, font or img can be used

Copyright © 2023 DrayTek Corp

V-1-6 Configuration Backup

This function allows the backup and restoration of Vigor router settings.

System Maintenance >> Configuration Backup

Configuration Backup / Restoration

Restoration

Restore settings from an cfg file.

This file is encrypted with password:

選擇檔案 未選擇任何檔案

Restore

Backup

Backup current settings into an cfg file.

Normal backup.

Protect full file with password.

Backup

Available settings are explained as follows:

Item	Description
Restore	<p>Restore settings from an cfg file - Click the Select File button to specify a file to be restored or click USB Storage (if a USB storage disk connected) to choose the configuration file.</p> <p>This file is encrypted with password - Select to specify a password.</p> <p>Restore - Click to initiate restoration of configuration. If the backup file is encrypted, you will be asked to enter the password.</p>
Backup	<p>Click it to perform the configuration backup of this router.</p> <p>Normal backup - Select to backup without a password.</p> <p>Protect full file with password- Select to encrypt the backup with a password. You will be prompted to enter the password as shown below:</p> <div style="border: 1px solid black; padding: 5px; margin: 5px 0;"> <p>Backup</p> <p>Backup current settings into an cfg file.</p> <p><input type="radio"/> Normal backup.</p> <p><input checked="" type="radio"/> Protect full file with password.</p> <p> Password <input style="width: 100px;" type="text"/> (Max. 23 characters allowed)</p> <p> Confirm Password <input style="width: 100px;" type="text"/> (Max. 23 characters allowed)</p> <p> Note: Only 1-9, A-Z, a-z, and ,;:<>+= ?@#^!() are allowed.</p> <p style="text-align: center;">Backup</p> </div> <ul style="list-style-type: none"> ● Password - Enter a new password for encrypting the configuration file. ● Confirm Password - Enter the new password again for confirmation. <p>Backup - Click to initiate the backup process.</p>

Backing up the Configuration

Follow the steps below to backup your configuration.

1. Go to **System Maintenance >> Configuration Backup**.
2. Click the **Backup** button, and the File Download dialog will be shown. Depending on your browser, you may be prompted to select a location to save the file, or the file may be saved in the default download location of your browser.

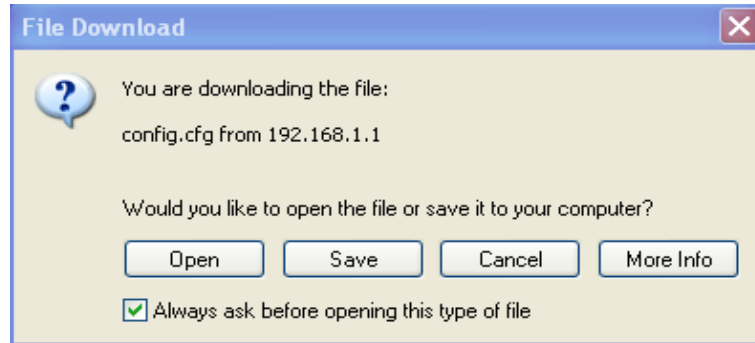

The configuration will download automatically to your computer as a file named **config.cfg**. The above example is using **Windows** platform for demonstrating examples. The **Mac** or **Linux** platform will appear different windows, but the backup function is still available.



Info

Configuration Backup does not include certificates stored on the router. Please back up certificates separately by going to **Certificate Management >> Certificate Backup**.

Restoring the Configuration

1. Go to **System Maintenance >> Configuration Backup**. The following windows will be shown.
2. Click the **Choose File** button under **Restoration** to bring up the open file dialog box to select the configuration file to be uploaded and restored.
3. Click the **Restore** button and wait for few seconds.

V-1-7 Configuration Export

Configuration for Vigor3912 can be exported as an user-readable text-based (.exp) file which can be applied to other Vigor router.

In addition, it is possible to import an ".exp" file from other DrayTek routers onto the Vigor3912.

System Maintenance >> Configuration Export

Configuration Export / Import

Import

Import settings from an exp file.

This file is encrypted with password:

選擇檔案 未選擇任何檔案

Export

Export current settings into an exp file for different draytek models.

Do not encrypt.

Encrypt password fields.

Protect full file with password.

Available settings are explained as follows:

Item	Description
Import	<p>This file is encrypted with password - Check the box and enter a password for decrypting the configuration file (if the .exp file is encrypted).</p> <p>Click the Select File button to specify an exp file.</p> <p>Import - Click to import a configuration file. If the file is encrypted, you will need to enter the password set on the above password field.</p>
Export	<p>Do not encrypt - The configuration file (.exp) will be output as an fully user-readable text-based file.</p> <p>Encrypt password fields - The configuration file (.exp) will be output as a user-readable text-based file except for password related fields (user passwords will be encrypted).</p> <p>Protect full file with password - The configuration file is protected by full encryption. The password will be needed when importing the "exp" file on Vigor router.</p> <p>Export - Click it to export the configuration of Vigor router as a file with the extension of "exp".</p>

V-1-8 Webhook

Vigor router will send a report (webhook message) including WAN up, down, CPU usage, memory usage and etc. to a monitoring server periodically.

System Maintenance >> Webhook

Enable

Monitoring Server URL

Report Period
(1~1440 minutes)

OK

Cancel

Note:

Vigor Router will use HTTPS to send the Webhook message by default. When the Monitoring Server supports HTTP only, please configure the URL with HTTP://.

Available settings are explained as follows:

Item	Description
Enable	Select it to enable this function.
Monitoring Server URL	Enter the URL of a server.
Report Period	Define the interval time for each report to be sent.

Select OK to save changes on the page.

V-1-9 Syslog/Mail Alert

SysLog function is provided for users to monitor router.

System Maintenance >> SysLog / Mail Alert Setup

SysLog / Mail Alert Setup

<p>SysLog Access Setup</p> <p><input checked="" type="checkbox"/> Enable</p> <p>Syslog Save to:</p> <p><input checked="" type="checkbox"/> Syslog Server</p> <p><input type="checkbox"/> USB Disk</p> <p style="margin-left: 20px;">Maximum Syslog folder space: <input type="text" value="1"/> GB</p> <p style="margin-left: 20px;">When Syslog folder is full: <input type="text" value="Overwrite oldest logs"/></p> <p>Router Name <input type="text" value="DrayTek"/></p> <p>Primary Syslog Server</p> <p>Server IP/Hostname: <input type="text"/></p> <p>Destination Port: <input type="text" value="514"/></p> <p>Secondary Syslog Server</p> <p>Server IP/Hostname: <input type="text"/></p> <p>Destination Port: <input type="text" value="514"/></p> <p>Mail Syslog <input type="checkbox"/> Enable</p> <p>Enable syslog message:</p> <p><input checked="" type="checkbox"/> Firewall Log</p> <p><input checked="" type="checkbox"/> VPN Log</p> <p><input checked="" type="checkbox"/> User Access Log / Hotspot User Information</p> <p><input checked="" type="checkbox"/> WAN Log</p> <p><input checked="" type="checkbox"/> Router/DSL information</p>	<p>Mail Alert Setup</p> <p><input type="checkbox"/> Enable <input type="button" value="Send a test e-mail"/></p> <p>Interface: <input type="text" value="Any"/></p> <p>SMTP Server: <input type="text"/></p> <p>SMTP Port: <input type="text" value="25"/></p> <p>Mail To: <input type="text"/></p> <p>Sender Address: <input type="text"/></p> <p>Connection Security: <input type="text" value="Plaintext"/></p> <p><input type="checkbox"/> Authentication</p> <p>Username: <input type="text" value="Max: 128 characters"/></p> <p>Password: <input type="text" value="Max: 128 characters"/></p> <p>Enable E-Mail Alert:</p> <p><input checked="" type="checkbox"/> DoS Attack</p> <p><input checked="" type="checkbox"/> APPE</p> <p><input checked="" type="checkbox"/> VPN LOG</p> <p><input type="checkbox"/> Debug Log <input type="button" value="Download"/></p>
--	--

Note:

1. USB Syslog space is available from 256-1024 MB or 1-16 GB.
2. Mail Syslog cannot be activated unless USB Disk is ticked for "Syslog Save to".
3. Mail Syslog feature will send the Syslog when it is full.

Available settings are explained as follows:

Item	Description
SysLog Access Setup	<p>Enable - Check Enable to activate function of syslog.</p> <p>Syslog Save to - Check Syslog Server to save the log to Syslog server. Check USB Disk to save the log to the attached USB storage disk.</p> <ul style="list-style-type: none"> ● Maximum Syslog folder space - Set the storage space as 1 GB or 100MB. ● When Syslog folder is full - When Syslog folder is full, simply overwrite the oldest logs or stop logging.
Router Name	<p>Shows the name of the router set in System Maintenance >> Management. This name will be used to identify the router in the Syslog entries.</p> <p>To set or modify the router name, click the hyperlink and you will be taken to System Maintenance >> Management where you can enter the value.</p>
Primary Syslog Server / Secondary Syslog Server	<p>Primary Syslog Server / Secondary Syslog Server - Vigor router will send the data to Syslog server for analysis based</p>

	<p>on the server settings configured here. It might send to both servers simultaneously if primary and secondary servers are set; or send to either one of the servers which has been set here.</p> <p>Server IP Address /Hostname - Enter the IP address / hostname of the Syslog server.</p> <p>Destination Port - Enter the port for the Syslog server.</p> <p>Mail Syslog - Select to enable sending Syslog messages by email.</p> <p>Enable syslog message - Select the events to be recorded by syslog.</p>
<p>Mail Alert Setup</p>	<p>Enable - Select to enable the Mail Alert.</p> <p>Send a test e-mail - Click to send a test email message using the settings below.</p> <p>Interface - Specify the WAN interface for a mail passing through.</p> <p>SMTP Server - Enter the address of the SMTP server used to send email.</p> <p>SMTP Port - Enter the port of the SMTP server. Default setting is 25.</p> <p>Mail To - Enter the email address of the recipient.</p> <p>Sender Address - Assign a mail address for sending mails out.</p> <p>Connection Security - Select a method (Plaintext, SSL or StartTLS) to ensure the connection security. SSL means to use port 465 for SMTP server for some e-mail server uses https as the transmission method.</p> <ul style="list-style-type: none"> ● Accept using plain text if StartTLS connection failed. ● Force StartTLS. Stop if StartTLS connection failed. <p>Authentication - Select this checkbox and enter the username and password if the SMTP server requires authentication.</p> <ul style="list-style-type: none"> ● User Name - Enter the user name for authentication. ● Password - Enter the password for authentication. <p>Enable E-mail Alert - Select the event types that will trigger email alerts.</p>

Select **OK** to save changes on the page, or **Clear** to reset all settings to factory defaults.

To view the Syslog message, please follow the steps below:

1. On the **Syslog / Mail Alert Setup** screen, enter the monitor PC's IP address in the **Server IP Address** field.
2. On the **Syslog / Mail Alert Setup** screen, enter the monitor PC's IP address in the **Server IP Address** field.

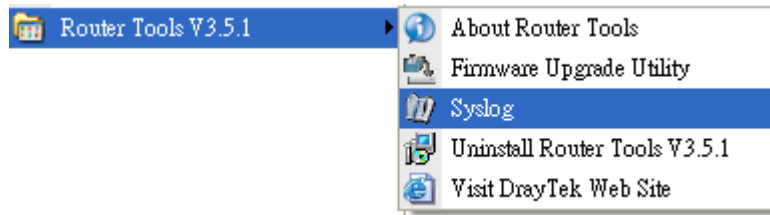

3. In the Syslog application, select the router you wish to monitor. Remember to select the network adapter to be used to connect to the router under Network Information, or else Syslog traffic cannot be received from the router.

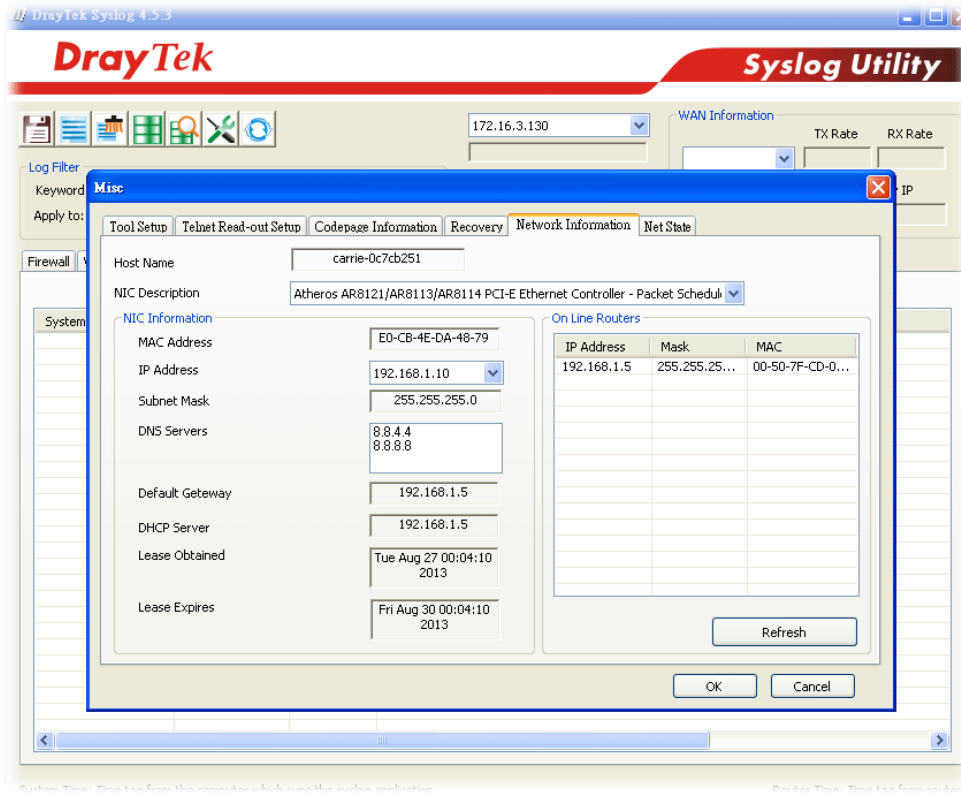

V-1-10 Time and Date

This section allows you to configure settings related to the system date and time.

System Maintenance >> Time and Date

Time Information

Current System Time	2023 Mar 21 Tue 7 : 15 : 27	Inquire Time
---------------------	-----------------------------	--------------

Time Setup

<input type="radio"/> Use Browser Time	
<input checked="" type="radio"/> Use Internet Time	
Time Server	<input type="text" value="pool.ntp.org"/>
Priority	<input type="text" value="Auto"/>
Time Zone	<input type="text" value="Auto"/>
Automatically Update Interval	<input type="text" value="30 mins"/>
Send NTP Request Through	<input type="text" value="Auto"/>

Available settings are explained as follows:

Item	Description
Current System Time	Click Inquire Time to retrieve the current time from the time server.
Use Browser Time	Select this option to let the router set its system time using the time reported by the web browser.
Use Internet Time	Select this option to let the router set its system time by retrieving time information from the specified network time server using the Network Time Protocol (NTP).
Time Server	Enter the IP address / Host name of the time server.
Priority	Select Auto or IPv6 First as the priority.
Time Zone	Select the time zone where the router is located.
Automatically Update Interval	Select the time interval at which the router updates the system time.
Send NTP Request Through	Specify a WAN interface to send NTP request for time synchronization.

Select **OK** to save changes on the page, or **Cancel** to discard changes without saving.

V-1-11 SNMP

This section allows you to configure settings for SNMP and SNMPV3 services.

The SNMPv3 is **more secure than SNMP** through the use of encryption (supports AES and DES) and authentication (supports MD5 and SHA) for the management needs.

SNMP Setup

<input checked="" type="checkbox"/> Enable SNMP Agent			
<input checked="" type="checkbox"/> Enable SNMPv3 Agent			
USM User	<input type="text"/>		
Auth Algorithm	No Auth ▾		
Auth Password	<input type="text"/>		
Privacy Algorithm	No Priv ▾		
Privacy Password	<input type="text"/>		
<input checked="" type="checkbox"/> Enable SNMPv2C Agent			
Get Community	public		
Set Community	private		
Manager Host IP(IPv4)	Index	IP	Subnet Mask
	1	<input type="text"/>	<input type="text"/>
	2	<input type="text"/>	<input type="text"/>
	3	<input type="text"/>	<input type="text"/>
Manager Host IP(IPv6)	Index	IPv6 Address	/ Prefix Length
	1	<input type="text"/>	/0
	2	<input type="text"/>	/0
	3	<input type="text"/>	/0
Trap Community	public		
Notification Host IP(IPv4)	Index	IP	
	1	<input type="text"/>	
	2	<input type="text"/>	
Notification Host IP(IPv6)	Index	IPv6 Address	
	1	<input type="text"/>	
	2	<input type="text"/>	
Trap Timeout	<input type="text" value="10"/>		Seconds
<input checked="" type="checkbox"/> Enable SNMPv1 Agent			

Note:

SNMP service also shall be enabled for Internet access in [System Maintenance >> Management](#).

Available settings are explained as follows:

Item	Description
Enable SNMP Agent	Check to enable SNMP function. Then, enable SNMPv1 agent, SNMv2C, and / or SNMPv3 agent.
Enable SNMPv3 Agent	Check to enable SNMPv3 function.
USM User	USM means user-based security mode. Enter the username to be used for authentication. The maximum allowed length is 23 characters.
Auth Algorithm	Choose one of the hashing methods to be used with the authentication algorithm.
Auth Password	Enter a password for authentication. The maximum allowed length is 23 characters.
Privacy Algorithm	Choose an encryption method as the privacy algorithm.
Privacy Password	Enter a password for privacy. The maximum allowed length is 23 characters.
Enable SNMPv2C Agent	Check to enable SNMPv2C function.
Get Community	Enter the Get Community string. The default setting is public. Devices that send requests to retrieve information

	using get commands must pass the correct Get Community string. The maximum allowed length is 23 characters.
Set Community	Enter the Set Community string. The default setting is private . Devices that send requests to change settings using set commands must pass the correct Set Community string. The maximum length of the text is 23 characters.
Manager Host IP (IPv4)	Enter the IPv4 address of hosts that are allowed to issue SNMP commands. If this field is left blank, any IPv4 LAN host is allowed to issue SNMP commands.
Manager Host IP (IPv6)	Enter the IPv6 address of hosts that are allowed to issue SNMP commands. If this field is left blank, any IPv6 LAN host is allowed to issue SNMP commands.
Trap Community	Enter the Trap Community string. The default setting is public . Devices that send unsolicited messages to the SNMP console must pass the correct Trap Community string. The maximum length of the text is 23 characters.
Notification Host IP (IPv4)	Enter the IPv4 address of hosts that are allowed to be sent SNMP traps.
Notification Host IP (IPv6)	Enter the IPv6 address of hosts that are allowed to be sent SNMP traps.
Trap Timeout	The default setting is 10 seconds.
Enable SNMPv1 Agent	Check to enable SNMPv1 function.

Select **OK** to save changes on the page, or **Cancel** to discard changes without saving.

V-1-12 Management

This page allows you to manage the settings for Internet/LAN Access Control, Access List from Internet, Management Port Setup, TLS/SSL Encryption Setup, CVM Access Control and Device Management.

The management pages for IPv4 and IPv6 protocols are different.

V-1-12-1 IPv4 Management Setup

System Maintenance >> Management



IPv4 Management Setup	IPv6 Management Setup	LAN Access Setup																																	
Router Name <input type="text" value="DrayTek"/>																																			
<input type="checkbox"/> Default: Disable Auto-Logout <input type="checkbox"/> Enable Validation Code in Internet/LAN Access																																			
Internet Access Control <input checked="" type="checkbox"/> Allow management from the Internet Domain name allowed <input type="text"/> <input type="checkbox"/> FTP Server <input type="checkbox"/> HTTP Server <input checked="" type="checkbox"/> Enforce HTTPS Access <input checked="" type="checkbox"/> HTTPS Server <input type="checkbox"/> Telnet Server <input type="checkbox"/> TR069 Server <input type="checkbox"/> SSH Server <input type="checkbox"/> SNMP Server <input checked="" type="checkbox"/> Disable PING from the Internet																																			
Access List from the Internet <input type="checkbox"/> Apply Access List to PING <table border="1"> <thead> <tr> <th>List Type</th> <th>Index</th> <th>Description</th> </tr> </thead> <tbody> <tr><td>IP Object</td><td>None</td><td></td></tr> <tr><td>IP Object</td><td>None</td><td></td></tr> <tr><td>IP Object</td><td>None</td><td></td></tr> <tr><td>IP Object</td><td>None</td><td></td></tr> <tr><td>IP Object</td><td>None</td><td></td></tr> <tr><td>IP Object</td><td>None</td><td></td></tr> <tr><td>IP Object</td><td>None</td><td></td></tr> <tr><td>IP Object</td><td>None</td><td></td></tr> <tr><td>IP Object</td><td>None</td><td></td></tr> <tr><td>IP Object</td><td>None</td><td></td></tr> </tbody> </table> <p>Note: Access list type: Hostname, single IP address supported for corresponding domain name.</p>			List Type	Index	Description	IP Object	None		IP Object	None		IP Object	None		IP Object	None		IP Object	None		IP Object	None		IP Object	None		IP Object	None		IP Object	None		IP Object	None	
List Type	Index	Description																																	
IP Object	None																																		
IP Object	None																																		
IP Object	None																																		
IP Object	None																																		
IP Object	None																																		
IP Object	None																																		
IP Object	None																																		
IP Object	None																																		
IP Object	None																																		
IP Object	None																																		
Management Port Setup <input checked="" type="radio"/> User Define Ports <input type="radio"/> Default Ports Telnet Port <input type="text" value="23"/> (Default: 23) HTTP Port <input type="text" value="80"/> (Default: 80) HTTPS Port <input type="text" value="443"/> (Default: 443) FTP Port <input type="text" value="21"/> (Default: 21) TR069 Port <input type="text" value="8069"/> (Default: 8069) SSH Port <input type="text" value="22"/> (Default: 22) Note: Ports 8001 and 8043 are used for Hotspot Web Portal.																																			
Brute Force Protection <input checked="" type="checkbox"/> Enable brute force login protection <input checked="" type="checkbox"/> FTP Server <input checked="" type="checkbox"/> HTTP Server <input checked="" type="checkbox"/> HTTPS Server <input checked="" type="checkbox"/> Telnet Server <input checked="" type="checkbox"/> TR069 Server <input checked="" type="checkbox"/> SSH Server <input checked="" type="checkbox"/> VPN Server Maximum login failures <input type="text" value="5"/> times Penalty period <input type="text" value="300"/> seconds																																			
Blocked IP List																																			
TLS/SSL Encryption Setup <input checked="" type="checkbox"/> Enable TLS 1.2 <input type="checkbox"/> Enable TLS 1.1 <input type="checkbox"/> Enable TLS 1.0 <input type="checkbox"/> Enable SSL 3.0																																			
AP Management <input checked="" type="checkbox"/> Enable AP Management <input checked="" type="checkbox"/> Device Management <input type="checkbox"/> Respond to external device																																			

OK

Available settings are explained as follows:

Item	Description
Router Name	Enter the router name as provided by ISP.
Default: Disable Auto-Logout	If enabled, the auto-logout function for the web user interface will be disabled.

	 <p>The web user interface will not terminate until you manually click the Logout icon.</p>
Enable Validation Code in Internet/LAN Access	<p>If enabled, Vigor router will require users to enter a validation code as shown in an image when they log in.</p>
Internet Access Control	<p>Allow management from the Internet - Enable the checkbox to allow system administrators to login from the Internet, and then select the specific services that are allowed to be remotely administered.</p> <p>Domain name allowed - This setting is only available if DNS filtering is enabled, applying DNS filter profile in firewall rules, or enabling DNS Filter Local Setting. The router will only allow connections to the WebUI using domain addresses configured in either DDNS profiles or this section.</p> <p>If DNS filtering is disabled, this setting will be disabled, and any domain address that resolves to the router's WAN IP address can be used to connect to the WebUI.</p> <p>Disable PING from the Internet - Select to reject all PING packets from the Internet. For increased security, this setting is enabled by default.</p>
Access List from the Internet	<p>The ability of system administrators to log into the router can be restricted to up to 10 specific hosts or networks.</p> <p>Apply Access List to PING - When this option is checked and Disable PING from the Internet is unchecked, pings originating from the Internet will be accepted only if they are from one of the IP addresses and/or subnet masks specified below. This option has no effect if Disable PING from the Internet is checked, which blocks all pings from the Internet.</p> <p>Type - Select IP Object or Hostname.</p> <p>Index - Select the index number of a configured IP object, keyword object or IP group object.</p> <p>Description - Shows a brief comment for the selected IP object (with subnet mask).</p>
Management Port Setup	<p>User Define Ports - Check to specify user-defined port numbers for the Telnet, HTTP, HTTPS, FTP, TR-069 and SSH servers.</p> <p>Default Ports - Check to use standard port numbers for the Telnet and HTTP servers.</p>
Brute Force Protection	<p>Any client trying to access into Internet via Vigor router will be asked for passing through user authentication. Such feature can prevent Vigor router from attacks when a hacker tries every possible combination of letters, numbers and</p>

	<p>symbols until find out the correct combination of password.</p> <p>Enable brute force login protection - Select to enable detection of brute force login attempts.</p> <p>Maximum login failure - Specify the maximum number of failed login attempts before further login is blocked.</p> <p>Penalty period - Set the lockout time after maximum number of login attempts has been exceeded. The user will be unable to attempt to log in until the specified time has passed.</p> <p>Blocked IP List - Display, in a new browser window, IP addresses that are currently blocked from logging into the router.</p>
TLS/SSL Encryption Setup	<p>Enable SSL 3.0 and TLS 1.0/1.1/1.2 - Check the box to enable SSL 3.0/1.0/1.1/1.2 encryption protocols.</p> <p>For improved security, the HTTPS and SSL VPN servers that are built into the router have been upgraded to TLS 1.x protocol. If you are using an old web browser (eg. IE 6.0) or an old version of the SmartVPN Client, you may need to enable SSL 3.0 to connect to the router. However, it is recommended that you instead upgrade your web browser or SmartVPN client to a version that supports TLS protocols that are far more secure than SSL.</p>
AP Management	<p>Enable AP Management - Check to enable the access point management function. If not, menu items related to Central Management>>AP will be hidden.</p>
Device Management	<p>Check to enable the device management function.</p> <p>Respond to external device - If selected, Vigor3912 will function as a slave device. When an external device (master device) sends packets to the Vigor3912 to attempt to manage it, the Vigor3912 will respond to the request coming from the external device which is able to manage Vigor3912.</p>

Select OK to save changes on the page.

V-1-12-2 IPv6 Management Setup

System Maintenance >> Management



IPv4 Management Setup	IPv6 Management Setup	LAN Access Setup																																												
<p>Management Access Control</p> <p><input type="checkbox"/> Allow management from the Internet</p> <p> <input type="checkbox"/> Telnet Server (Port : 23)</p> <p> <input type="checkbox"/> HTTP Server (Port : 80) <input type="checkbox"/> Enforce HTTPS Access</p> <p> <input type="checkbox"/> HTTPS Server (Port : 443)</p> <p> <input type="checkbox"/> SSH Server (Port : 22)</p> <p> <input type="checkbox"/> SNMP Server (Port : 161)</p> <p><input checked="" type="checkbox"/> Disable PING from the Internet</p> <p>IPv6 Address Security Option</p> <p><input checked="" type="checkbox"/> Enable Random Interface Identifiers(IIDs) instead of EUI-64 IIDs</p> <hr/> <p>Access List from the Internet</p> <p><input type="checkbox"/> Apply Access List to PING</p> <table border="1"> <thead> <tr> <th>List</th> <th>Type</th> <th>Index</th> <th>Description</th> </tr> </thead> <tbody> <tr><td>1</td><td>IPv6 Object</td><td>None</td><td></td></tr> <tr><td>2</td><td>IPv6 Object</td><td>None</td><td></td></tr> <tr><td>3</td><td>IPv6 Object</td><td>None</td><td></td></tr> <tr><td>4</td><td>IPv6 Object</td><td>None</td><td></td></tr> <tr><td>5</td><td>IPv6 Object</td><td>None</td><td></td></tr> <tr><td>6</td><td>IPv6 Object</td><td>None</td><td></td></tr> <tr><td>7</td><td>IPv6 Object</td><td>None</td><td></td></tr> <tr><td>8</td><td>IPv6 Object</td><td>None</td><td></td></tr> <tr><td>9</td><td>IPv6 Object</td><td>None</td><td></td></tr> <tr><td>10</td><td>IPv6 Object</td><td>None</td><td></td></tr> </tbody> </table> <p>Note:</p> <p>1Telnet / Http server port is the same as IPv4.</p> <p>2Access list type: Hostname, single IP address supported for corresponding domain name.</p>			List	Type	Index	Description	1	IPv6 Object	None		2	IPv6 Object	None		3	IPv6 Object	None		4	IPv6 Object	None		5	IPv6 Object	None		6	IPv6 Object	None		7	IPv6 Object	None		8	IPv6 Object	None		9	IPv6 Object	None		10	IPv6 Object	None	
List	Type	Index	Description																																											
1	IPv6 Object	None																																												
2	IPv6 Object	None																																												
3	IPv6 Object	None																																												
4	IPv6 Object	None																																												
5	IPv6 Object	None																																												
6	IPv6 Object	None																																												
7	IPv6 Object	None																																												
8	IPv6 Object	None																																												
9	IPv6 Object	None																																												
10	IPv6 Object	None																																												

OK

Available settings are explained as follows:

Item	Description
Management Access Control	<p>Allow management from the Internet - Select to allow system administrators to login from the Internet, and then select the specific services that are allowed to be remotely administered.</p> <p>Disable PING from the Internet - Select to reject all PING packets from the Internet. For increased security, this setting is enabled by default.</p>
IPv6 Address Security Option	<p>Enable Random Interface Identifiers (IIDs)... - The IPv6 address will be generated randomly but not using LAN/WAN MAC to prevent the attack from the hacker.</p>
Access List from the Internet	<p>The ability of system administrators to log into the router can be restricted to up to 10 specific hosts or networks.</p> <p>Apply Access List to PING - When this option is checked and Disable PING from the Internet is unchecked, pings originating from the Internet will be accepted only if they are from one of the IP addresses and/or subnet masks specified below. This option has no effect if Disable PING from the Internet is checked, such that no pings from the Internet are accepted.</p>

Type - Select IPv6 Object or Hostname.

Index - Select the index number of a configured IPv6 object.

Select OK to save changes on the page.

V-1-12-3 LAN Access Control

System Maintenance >> Management



IPv4 Management Setup	IPv6 Management Setup	LAN Access Setup
<input checked="" type="checkbox"/> Allow management from LAN		
<input checked="" type="checkbox"/> FTP Server		
<input checked="" type="checkbox"/> HTTP Server <input type="checkbox"/> Enforce HTTPS Access		
<input checked="" type="checkbox"/> HTTPS Server		
<input checked="" type="checkbox"/> Telnet Server		
<input checked="" type="checkbox"/> TR069 Server		
<input checked="" type="checkbox"/> SSH Server		
Apply To Subnet		Index in IP Object
<input checked="" type="checkbox"/> LAN1	<input type="checkbox"/>	<input type="text"/>
<input checked="" type="checkbox"/> LAN2	<input type="checkbox"/>	<input type="text"/>
<input checked="" type="checkbox"/> LAN3	<input type="checkbox"/>	<input type="text"/>
<input checked="" type="checkbox"/> LAN4	<input type="checkbox"/>	<input type="text"/>
<input checked="" type="checkbox"/> LAN5	<input type="checkbox"/>	<input type="text"/>
<input checked="" type="checkbox"/> LAN6	<input type="checkbox"/>	<input type="text"/>
<input checked="" type="checkbox"/> LAN7	<input type="checkbox"/>	<input type="text"/>
<input checked="" type="checkbox"/> LAN8	<input type="checkbox"/>	<input type="text"/>
<input checked="" type="checkbox"/> LAN9	<input type="checkbox"/>	<input type="text"/>
<input checked="" type="checkbox"/> LAN10	<input type="checkbox"/>	<input type="text"/>

Available settings are explained as follows:

Item	Description
Allow management from LAN	Enable the checkbox to allow system administrators to login from LAN interface. There are several servers provided by the system which allow you to manage the router from LAN interface. Check the box(es) to specify.
Apply To Subnet	Check the LAN interface for the administrator to use for accessing into web user interface of Vigor router. Index in IP Object - Type the index number of the IP object profile. Related IP address will appear automatically.

Select OK to save changes on the page.

V-1-13 Self-Signed Certificate

A self-signed certificate is a *unique* identification for the device (e.g., Vigor router) which generates the certificate by itself to ensure the router security. Such self-signed certificate is signed with its own private key.

The self-signed certificate can be used for services such as SSL VPN and HTTPS. In addition, it can be created for free by using a wide variety of tools.

[System Maintenance >> Self-Signed Certificate](#)

Self-Signed Certificate Information

Certificate Name :	self-signed
Issuer :	C=TW, ST=HsinChu, L=HuKou, O=DrayTek Corp., OU=DrayTek Support, CN=Vigor Router
Subject :	C=TW, ST=HsinChu, L=HuKou, O=DrayTek Corp., OU=DrayTek Support, CN=Vigor Router
Subject Alternative Name :	DNS:www.draytek.com
Valid From :	Apr 09 11:59:19 2023 GMT+00:00
Valid To :	May 08 11:59:19 2024 GMT+00:00
PEM Format Content :	<pre>-----BEGIN CERTIFICATE----- MIIDpjCCAo6gAwIBAgIJALV1i4itiTWGMA0GCSqGSIb3DQEBCwUAMHgx CzA3BgNV BAYTA1RXMRwDgYDVQQIDAdIc2luQ2h1MQ4wDAYDVQQHDAVIdUtv dTEwMBQGA1UE CgwNRHJheVR1ayBDb3JwLjEYMBYGA1UECwwPRHJheVR1ayBTdXBwB3J0MRUwEwYD VQQDDAxwYWwv dvc iBSb3V0ZXIwHhcNMjMwNDU1MTE1OTU1OTU1OTU1OTU1OTU1 WjB4MQswCQYDVQQGEwJUVzEQMA4GA1UECAwHSHNpbkNodTEOMAwGA1UEBmVFSHVl b3UxZjAUBG9wMURyYX1UZlZsQ29ycC4xGDABG9wMURyYX1UZlZsQ29ycC4xGDAB cG9ydEVMBG9wMURyYX1UZlZsQ29ycC4xGDABG9wMURyYX1UZlZsQ29ycC4xGDAB AQ8AMIIBBgKCAQEAvk6JVb2oz/HEEzVehTEBBdmsCB1snQdm1/eVrI7iLgS98wD CynVptPWioVL1/F7IFsUX8LKKNosto5e2eQb7V1+Hz+s8sEQINBLSJFLmgIU5RMW 2XmUlgZaMLR2275YNwW/13hPA0qZtYun42eNTwi7fFrW0YUZZJTjxr8oRiwKjvV Mw8K+tahia/aNX43vJ1uE7+kLzAWRuB+BN7UMfEELD6rW6WE8tY1UoUFPXKkKJ/ a3qekkd6SsJ3ogFRKq2mpuY8CgeZ3r1ysYZimo9gTEepug5LNHzhN2Wn1phrPuY4 y+msEp/DWU7XFT7D29wH82cpKXtB4t1QUogJ6wIDAQABozMwMTATBgNVHSUEDDAK BgggrBgEFBQcDATAAgNVHREEEzARgg93d3cuZHJheXR1ay5jb20wDQYJKoZIhvcN AQELBQADggEBAEoakTnqVry1LMoPqzbuk3zRmoC4ehKSNIyBYM8bmWzGxeZjtQoc fgGf8FsXBuGQmAt0Tk2adFmuE0MRz90bpZEI7e/2wYereakCAANI0V9k4ghhCt0E szX04mnHuHzJy8jM/ZI0LKNp221/AGvP7GdW8RsYrP+Xz0Y3uiE0sad3IhyA4LrH 07+eVDAvyRrWMMx9cEuP/dn1VQhK3WtGgZMrtVaTgcMvALw6g1pKqVJtEMXiThh +EX2RmSdlwD4a41n5Xvnt3rZ+/gxwjpMDXEULaHNSLKRq31W4jxXzUsbB8rIb6wmI gbp/pk05stff2T6vGoTPzVd5SEitjsaFqg0= -----END CERTIFICATE-----</pre>

Note:

1. Please setup the [System Maintenance >> Time and Date](#) correctly before you try to regenerate a self-signed certificate!!
2. The Time Zone MUST be setup correctly!!

Click [Regeneration](#) to open [Regenerate Self-Signed Certificate](#) window.

Regenerate Self-Signed Certificate

Certificate Name	self-signed
Subject Alternative Name	
Type	IP Address ▼
IP	<input type="text"/>
Subject Name	
Country (C)	<input type="text"/>
State (ST)	<input type="text"/>
Location (L)	<input type="text"/>
Organization (O)	<input type="text"/>
Organization Unit (OU)	<input type="text"/>
Common Name (CN)	<input type="text"/>
Email (E)	<input type="text"/>
Key Type	RSA ▼
Key Size	2048 Bit ▼

Enter all requested information including certificate name (used to differentiate different certificates), subject alternative name type and relational settings for subject name. Then click **GENERATE**.

V-1-14 Reboot System

The Web user interface may be used to restart your router. Click **Reboot System** from **System Maintenance** to bring up the following page.

System Maintenance >> Reboot System

Reboot System

Do you want to reboot your router ?

Using current configuration (Fast reboot)
 Using current configuration (Normal reboot)
 Using default configuration
 Wipe out all data (personal data like certificate, WCF license, web portal ..etc.)

Auto Reboot Time Schedule

Schedule Profile : , , ,

Note:
Action and Duration Time settings will be ignored.

Available settings are explained as follows:

Item	Description
Reboot System	<p>Select one of the following options, and press the Reboot Now button to reboot the router.</p> <p>Using current configuration (Fast reboot/Normal reboot) - Select this option to reboot the router using the current configuration.</p> <ul style="list-style-type: none"> ● Fast reboot - Reboot the router quickly by a certain daemon. ● Normal reboot - Reboot the router with current configurations slowly and completely. <p>Using default configuration - Select this option to reset the router's configuration to the factory defaults before rebooting.</p> <p>Wipe out all data - Select this option to reset Vigor system with default settings. Meanwhile, the data related to Linux application will be wipe out, too.</p>
Auto Reboot Time Schedule	<p>Schedule Profile - Select up to 4 user-configured schedules to reboot the router on a scheduled basis.</p>

Select **OK** to save changes on the page, or **Cancel** to discard changes without saving.



Info

When the system pops up Reboot System web page after you configure web settings, please click Reboot Now to reboot your router for ensuring normal operation and preventing unexpected errors of the router in the future.

V-1-15 Firmware Upgrade

Click System Maintenance>> Firmware Upgrade to upgrade firmware upgrade.

System Maintenance >> Firmware Upgrade



Firmware Version Status

<p>Current Firmware Version: 4.3.5</p> <p>Latest Firmware Version: Latest Firmware Detail</p>
--

Download Link: <https://www.draytek.com/support/latest-firmwares/>

Web Firmware Upgrade

<p>Select a firmware file.</p> <p><input type="button" value="選擇檔案"/> 未選擇任何檔案</p> <p>Click Upgrade to upload the file. <input type="button" value="Upgrade"/> <input type="button" value="Preview"/></p>
--

Note:

1. Upgrade using the ALL file will retain existing router configuration, whereas using the RST file will reset the configuration to factory defaults.
2. For firmware "downgrading", please consider using "restore backup firmware with config" to avoid potential config compatibility issue.

Available settings are explained as follows:

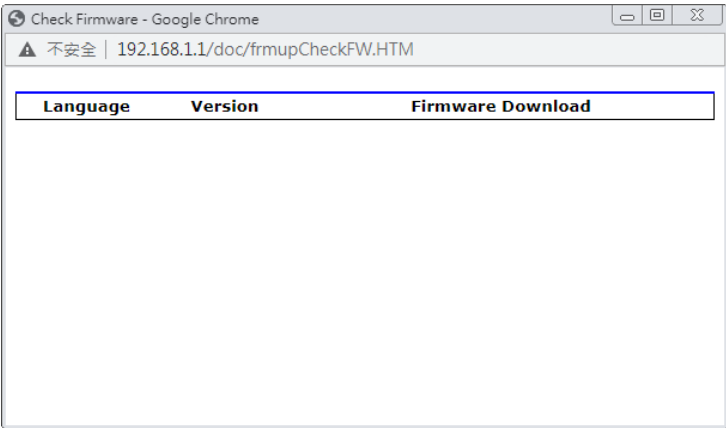
Item	Description
Firmware Versiono Status	<p>Check The Latest Firmware - Click to check for updated firmware.</p> <p>Any available new firmware files will be displayed and you can download any one of them by clicking Download. After the file has been downloaded, click Select followed by Upgrade to perform the firmware upgrade.</p> 
Web Firmware Upgrade	<p>Click Browse... to select the firmware file, followed by Upgrade to start the upgrade process, or Preview to display detailed information about the selected firmware file:</p>

V-1-16 Internal Service User List

User profiles (clients) defined and enabled in **User Management >> User Profile** will be displayed in this page.

Such page allows you to turn on or turn off security authentication service (offered by internal RADIUS) for each user profile without accessing into the User Management configuration page.

System Maintenance >> Internal Service User List

User Name	<input type="checkbox"/> Radius	<input type="checkbox"/> Local 802.1X	User Name	<input type="checkbox"/> Radius	<input type="checkbox"/> Local 802.1X
No valid User Profile					

Note:

1. Only the user profiles which is enabled in **User Management >> User Profile** will be listed here.
2. If you enable RADIUS or Local 802.1X for a user profile here, it will use the default authentication methods; however, you may change its authentication methods via **User Management >> User Profile**.

Available settings are explained as follows:

Item	Description
User Name	Display the name of the existed user profile. To modify the detailed settings, simply click the user name link to access into the web page for modification.
Radius	<p>Check the box to turn on the security authentication service offered by internal RADIUS server for the user profile.</p> <p>Uncheck the box to turn off security authentication service offered by internal RADIUS server for the user profile.</p> <p>If you check the box next to such item, all of the user profiles listed in this page will be enabled with RADIUS service enabled vice versa.</p>



Info

For the detailed setting (such as IP address, port number) configuration of internal RADIUS, refer to **Applications >> RADIUS/TACACS+**.

V-1-17 Dashboard Control

There are nine groups of setting information which can be displayed on Dashboard as a reference for administrator/user. Except for Front Panel and System Information, the settings information regarding to the groups listed on this page can be hidden if required.

System Maintenance >> Dashboard Control

<input type="checkbox"/> Front Panel
<input type="checkbox"/> System Information
<input checked="" type="checkbox"/> IPv4 LAN Information
<input checked="" type="checkbox"/> IPv4 Internet Access
<input checked="" type="checkbox"/> IPv6 Internet Access
<input checked="" type="checkbox"/> Interface
<input checked="" type="checkbox"/> Security
<input checked="" type="checkbox"/> System Resource
<input checked="" type="checkbox"/> Quick Access

OK Cancel

V-1-18 Max Connection

Set the maximum NAT session number.

Max Connection

Max. connection number	<input checked="" type="radio"/> 300K	<input type="radio"/> 500K	<input type="radio"/> 1000K
------------------------	---------------------------------------	----------------------------	-----------------------------

OK

Note:

It is recommended to choose a max. session number that just satisfies your need. Since a higher max. session number consumes more memory and leaves less memory for other features.

V-2 Bandwidth Management

Sessions Limit

When LAN clients share a common public IP address by means of Network Address Translation (NAT), the router must track NAT sessions so that traffic to and from the WAN can reach the intended destinations. There is a finite number of sessions that can be tracked by the router, and by setting session limits will ensure that the router does not run out of resources. This is especially important when P2P applications are used. P2P applications, such as BitTorrent, that attempt to simultaneously establish connections to as many WAN hosts as possible.

Bandwidth Limit

Bandwidth Limit ensures LAN clients get their fair share of network bandwidth by placing restrictions on upstream and downstream network speeds.

Quality of Service (QoS)

QoS (Quality of Service) ensures that all LAN clients receive their fair share of bandwidth that is required for applications to function properly and efficiently.

Without QoS, it is possible that certain applications may consume excessive network resources that they degrade performance of more important applications, especially ones that are less tolerant of jitter (delay variation) or lost or delayed packets. Additionally, at times of network congestion, QoS is able to prioritize different types of traffic according to their predefined priority, thus ensuring traffic of higher importance gets processed first.

A typical QoS deployment consists of two components:

- Classification: Identifying low-latency or crucial applications and marking them for high-priority service level enforcement throughout the network.
- Scheduling: Prioritizing packets by assigning them to different queues and service types according to service levels.

APP QoS

APP QoS allows QoS to be applied to select protocols and applications.

Protocols and applications fall into two categories: Traceable and Untraceable. Traceable applications are those whose traffic can be 100% traced, and can be assigned a specific QoS class. Untraceable applications, on the other hand, are detected when they attempt to establish connections to remote hosts, and all traffic between the remote hosts and the local network will be placed under QoS, within the same QoS class.

Web User Interface

Bandwidth management ensures efficient allocation of network bandwidth for various applications.

To set up Bandwidth Management, from the Main Menu, select **Bandwidth Management**.



V-2-1 Sessions Limit

To configure Sessions Limit, from the **Bandwidth Management** menu, select **Sessions Limit** to open the setup page.

Bandwidth Management >> Sessions Limit

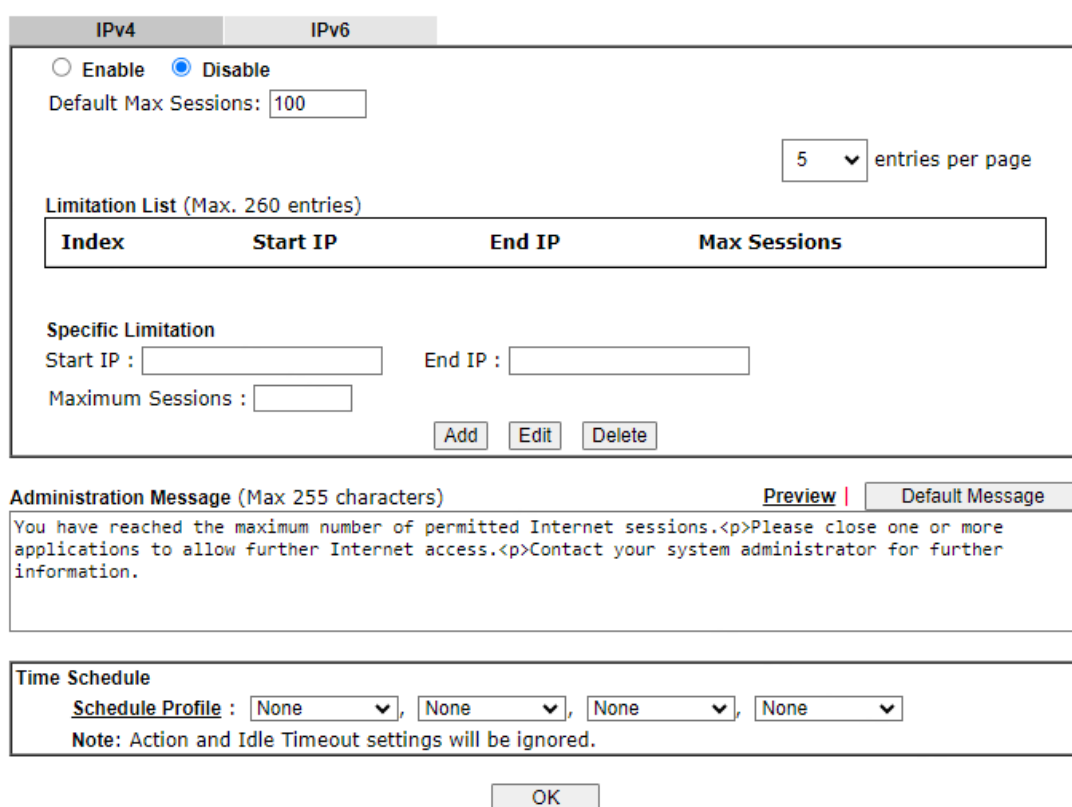

IPv4 IPv6

Enable Disable

Default Max Sessions:

5 entries per page

Limitation List (Max. 260 entries)

Index	Start IP	End IP	Max Sessions
-------	----------	--------	--------------

Specific Limitation

Start IP : End IP :

Maximum Sessions :

Add Edit Delete

Administration Message (Max 255 characters) [Preview](#) | [Default Message](#)

You have reached the maximum number of permitted Internet sessions.<p>Please close one or more applications to allow further Internet access.<p>Contact your system administrator for further information.

Time Schedule

Schedule Profile : , , ,

Note: Action and Idle Timeout settings will be ignored.

OK

To activate the function of limit session, simply click **Enable** and set the default session limit.

Available settings are explained as follows:

Item	Description
Enable/Disable	Enable - Select to activate session limit function. Disable - Select to deactivate session limit function.

	Default Max Session - The default maximum number of sessions allowed per LAN client, unless overridden by specifying a different number in the Limitation List.
Limitation List	Displays specific limitation entries.
Specific Limitation	<p>Start IP - The beginning IP address for this limit entry.</p> <p>End IP - The ending IP address for limit entry.</p> <p>Max Sessions - The maximum number of NAT sessions allowed per LAN client. If no value is entered, the Default Max Sessions value is used.</p> <p>Add - Creates a new limit entry using the above Specific Limitation values.</p> <p>Edit - To edit an existing entry, select the entry from the Limitation List, make the appropriate changes in Specific Limitation, then click Edit.</p> <p>Delete - To delete an entry, select it from the Limitation List, then click the Delete button.</p>
Administration Message	<p>Message to be displayed in a web browser on the LAN client when the maximum number of NAT sessions has been reached.</p> <p>Default Message - Click to reset the administration message to the factory default.</p>
Time Schedule	Schedule Profile - Specify up to 4 time schedule entries to enable or disable the WAN.

To save changes on the page, click OK.

V-2-2 Bandwidth Limit

To configure the Bandwidth Limit feature, from the **Bandwidth Management** menu, select **Bandwidth Limit** to bring up the configuration page.

Bandwidth Management >> Bandwidth Limit

IPv4
IPv6

Enable
 Disable
 IP Routed Subnet

Default Limit (Per User)

TX Limit: Kbps
 RX Limit: Kbps

Limitation List (Max. 260 entries)

Index	Start IP/Group	End IP/Object	TX limit	RX limit	Shared

Add Entry By: IP Range IP Object

Start IP: End IP:

Each
 Shared
 TX Limit: Kbps
 RX Limit: Kbps

Auto-Adjustment

Allow user to use more bandwidth than the assigned limit when there are bandwidth available.

Smart Bandwidth Limit

Apply the below limit to users not in Limitation List and user more than sessions

TX Limit : Kbps
 RX Limit : Kbps

Time Schedule

Schedule Profile : , , ,

Note:

1. Use "0" for TX/RX Limit for unlimited bandwidth.
2. Available bandwidth is calculated according to the maximum bandwidth detected or the Line Speed defined in WAN >> **General Setup** when in "According to Line Speed" Load Balance mode.
3. The Action and Idle Timeout settings in the Schedule Profile will be ignored.

To activate the function of limit bandwidth, simply click **Enable** and set the default upstream and downstream limit.

Available settings are explained as follows:

Item	Description
Enable / Disable	<p>Enable - Select to activate bandwidth limit function.</p> <p>Disable - Select to deactivate bandwidth limit function.</p> <p>IP Routed Subnet - Check this box to apply the bandwidth limit to the traffic via IP routed subnet.</p> <p>Default Limit (Per User)</p> <ul style="list-style-type: none"> ● TX Limit - Default upstream speed limit for each LAN client. Unit can be either Kbps or Mbps. Value must be between 0 (unlimited) and 30000. ● RX limit - Default downstream speed limit for each LAN client. Unit can be either Kbps or Mbps. Value must be

	between 0 (unlimited and 30000).
Limitation List	Displays specific limitation entries.
Add Entry By	<p>IP Range - All the IPs within the range defined will be restricted by bandwidth limit defined by TX Limit and RX Limit below.</p> <ul style="list-style-type: none"> ● Start IP - The beginning IP address for this limit entry. ● End IP - The ending IP address for limit entry. <p>IP Object - All the IPs specified by the selected IP object or IP group will be restricted by bandwidth limit defined by TX Limit and RX Limit below.</p> <ul style="list-style-type: none"> ● IP Group - Specify an IP group by using the drop down list. ● IP Object - Specify an IP object by using the drop down list. <p>Each - The specified bandwidth is the limit per LAN client.</p> <p>Shared - The specified bandwidth limits are the total allowed for all LAN clients within the range of IP addresses.</p> <ul style="list-style-type: none"> ● TX limit - The upstream limit. Unit can be either Kbps or Mbps. Value must be between 0 (unlimited) and 30000. ● RX limit - The downstream limit. Unit can be either Kbps or Mbps. Value must be between 0 (unlimited) and 30000. <p>Add - Creates a new limit entry using the above Specific Limitation values.</p> <p>Edit - To edit an existing entry, select the entry from the Limitation List, make the appropriate changes in Specific Limitation, then click Edit.</p> <p>Delete - To delete an entry, select it from the Limitation List, then click the Delete button.</p>
Auto-Adjustment	Allow user to use more bandwidth ... - Select to let the router automatically adjust the upstream and downstream limits based on available bandwidth.
Smart Bandwidth Limit	<p>This option restricts the bandwidth of LAN clients that are not in the limitation list when the network sessions exceed a predefined threshold.</p> <p>Apply the below limit to ... - The number of sessions a LAN client is allowed to have before Smart Bandwidth Limit activates.</p> <ul style="list-style-type: none"> ● TX limit - Upstream speed limit for each LAN client. Unit can be either Kbps or Mbps. Value must be between 0 (unlimited) and 30000. ● RX limit - Downstream speed limit for each LAN client. Unit can be either Kbps or Mbps. Value must be between 0 (unlimited) and 30000).
Time Schedule	Schedule Profile - Specify up to 4 time schedule entries to enable or disable the WAN.

V-2-3 Quality of Service

To configure Quality of Service, from the main menu, select **Bandwidth Management** menu, then click **Quality of Service** to bring up the configuration page.

Bandwidth Management >> Quality of Service

General Setup											Set to Factory Default	
Index	Enable	Direction	Inbound/ Outbound Bandwidth				Class 1	Class 2	Class 3	Others	Status	
WAN1	<input type="checkbox"/>	BOTH	100	Mbps	/	100	Mbps	25 %	25 %	25 %	25 %	Status
WAN3	<input type="checkbox"/>	BOTH	100	Mbps	/	100	Mbps	25 %	25 %	25 %	25 %	Status
WAN5	<input type="checkbox"/>	BOTH	100	Mbps	/	100	Mbps	25 %	25 %	25 %	25 %	Status
WAN6	<input type="checkbox"/>	BOTH	100	Mbps	/	100	Mbps	25 %	25 %	25 %	25 %	Status
WAN7	<input type="checkbox"/>	BOTH	100	Mbps	/	100	Mbps	25 %	25 %	25 %	25 %	Status
WAN8	<input type="checkbox"/>	BOTH	100	Mbps	/	100	Mbps	25 %	25 %	25 %	25 %	Status

Note:

QoS may not work properly if the bandwidth entered is not correct. Before enable QoS, you may run speed test (from e.g., <http://speedtest.net>) or contact your ISP for the accurate bandwidth.

Class Rule

Index	Enable	QoS Class	Local Address	Remote Address	DSCP	Service Type
Add						

Note:

- The packets that don't match any class rules above will be classified into 'Others'
- Go to [User Defined Service Type](#) to edit/delete user-defined service type profiles.

VoIP Prioritization

<input checked="" type="checkbox"/> Enable the First Priority for VoIP SIP/RTP: SIP UDP Port: <input type="text" value="5060"/> (Default: 5060)
--

Tag Outbound Traffic

Class 1	<input type="checkbox"/>	Add DSCP or Precedence Value	Default
Class 2	<input type="checkbox"/>	Add DSCP or Precedence Value	Default
Class 3	<input type="checkbox"/>	Add DSCP or Precedence Value	Default

OK Cancel

Available settings are explained as follows:

Item	Description
General Setup	<p>Index - Link of WAN interface.</p> <p>Enable - Check the box to enable the QoS function for WAN interface. If it is enabled, you can configure general QoS setting for each WAN interface.</p> <ul style="list-style-type: none"> Direction - Direction of traffic to which QoS is to be applied (Inbound, Outbound, or Both). <ul style="list-style-type: none"> IN - Apply QoS to incoming traffic only. OUT - Apply QoS to outgoing traffic only. BOTH - Apply to both incoming and outgoing traffic. Inbound/Outbound Bandwidth - The inbound / outbound bandwidth of the WAN. This option is not available on ADSL/VDSL WAN1 interface. Class 1 ~ 3 / Others - Percentage of bandwidth reserved for each class. <p>Status - Click to bring up the Online Statistics page that shows snapshots of statistics for the given WAN interface.</p>
Class Rule	<p>Define and list the Class rules.</p> <p>Index - Displays the class number that you can edit.</p> <p>Enable - Displays the status of this class rule.</p>

Item	Description
	<p>QoS Class - Displays the QoS class level.</p> <p>Local Address - Displays the local IP address for the rule.</p> <p>Remote Address - Displays the remote IP address for the rule.</p> <p>DSCP - Displays the levels of the data for processing with QoS control.</p> <p>Service Type - Displays detailed settings for the service type.</p> <p>Add - Click it to create a class rule for QoS.</p>
VoIP Prioritization	<p>Enable the First Priority for VoIP SIP/RTP - Select to allow VoIP traffic to receive the highest priority.</p> <p>SIP UDP Port - Port number to be monitored for SIP traffic.</p>
Tag Outbound Traffic	<p>Tag the outgoing traffic with the DSCP or Precedence value.</p> <p>Add DSCP or Precedence Value for Class 1 to Class 3 - Check to apply the DSCP or precedence value for each class.</p>

To save changes, click **OK**; to discard changes, click **Cancel**.

Online Statistics

Click the **Status** link in the **General Setup** section to show real-time online statistics of the WAN interface.

Bandwidth Management >> Quality of Service

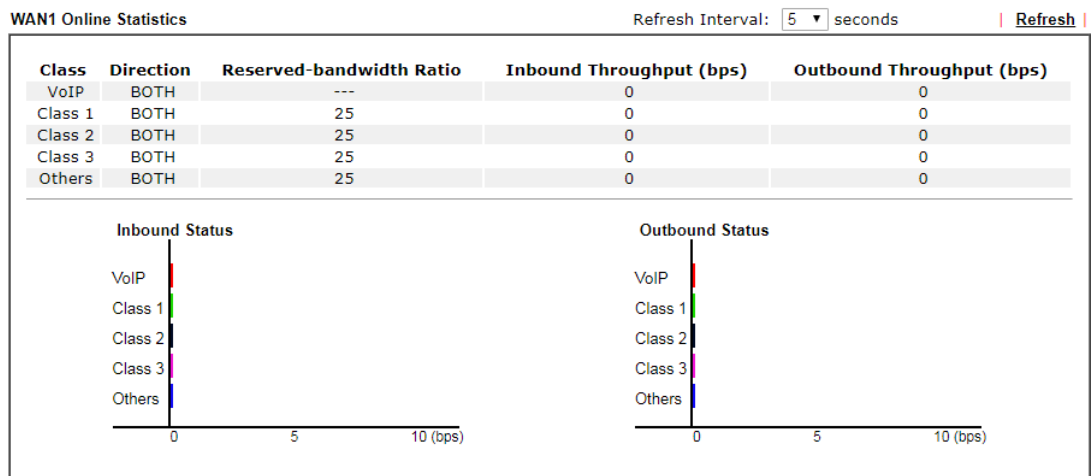

General Setup for WAN Interface

Click WAN interface number link to configure the limited bandwidth ratio for QoS of the WAN interface.

Bandwidth Management >> Quality of Service >> WAN1

Enable UDP Bandwidth Control
Limited_bandwidth Ratio %

Outbound TCP ACK Prioritize

Available settings are explained as follows:

Item	Description
Enable UDP Bandwidth Control	Select to restrict the bandwidth available to UDP traffic. The Limited_bandwidth Ratio value is the maximum percentage of bandwidth that can be used by UDP traffic. <ul style="list-style-type: none">● Limited_bandwidth Ratio - Enter a percentage value.
Outbound TCP ACK Prioritize	Select to give outbound ACK packets priority over other packets to ensure traffic is not slowed down because the remote host is waiting for ACK packets before further traffic will be sent.



Info

The rate of outbound/inbound must be smaller than the real bandwidth to ensure correct calculation of QoS. It is suggested to set the bandwidth value for inbound/outbound as 80% - 85% of physical network speed provided by ISP to maximize the QoS performance.

Add / edit the Class Rule for QoS

You can set up to 20 rules for one Class. If you want to edit an existed rule, please select the radio button of that one and click Edit to open the rule edit page for modification.

- To add a rule, click **Add** to bring up the configuration page. To edit an existing rule, select the rule by clicking the radio button in front of the rule, and then click **Edit** to bring up the configuration page.

Bandwidth Management >> Quality of Service

General Setup											Set to Factory Default
Index	Enable	Direction	Inbound/ Outbound Bandwidth			Class 1	Class 2	Class 3	Others	Status	
WAN1	<input type="checkbox"/>	BOTH ▾	100	Mbps ▾ /	100	Mbps ▾	25 %	25 %	25 %	25 %	Status
WAN3	<input type="checkbox"/>	BOTH ▾	100	Mbps ▾ /	100	Mbps ▾	25 %	25 %	25 %	25 %	Status
WAN5	<input type="checkbox"/>	BOTH ▾	100	Mbps ▾ /	100	Mbps ▾	25 %	25 %	25 %	25 %	Status
WAN6	<input type="checkbox"/>	BOTH ▾	100	Mbps ▾ /	100	Mbps ▾	25 %	25 %	25 %	25 %	Status
WAN7	<input type="checkbox"/>	BOTH ▾	100	Mbps ▾ /	100	Mbps ▾	25 %	25 %	25 %	25 %	Status
WAN8	<input type="checkbox"/>	BOTH ▾	100	Mbps ▾ /	100	Mbps ▾	25 %	25 %	25 %	25 %	Status

Note:

QoS may not work properly if the bandwidth entered is not correct. Before enable QoS, you may run speed test (from e.g., <http://speedtest.net>) or contact your ISP for the accurate bandwidth.

Class Rule

Index	Enable	QoS Class	Local Address	Remote Address	DSCP	Service Type
Add						

Note:

- The packets that don't match any class rules above will be classified into 'Others'
- Go to [User Defined Service Type](#) to edit/delete user-defined service type profiles.

- For adding a new rule, click **Add** to open the following page.

Bandwidth Management >> Quality of Service

Rule 1

<input checked="" type="checkbox"/> Enable	
IP Version	<input checked="" type="radio"/> IPv4 <input type="radio"/> IPv6
Local IP Address	<input type="text" value="Any"/> Edit
Remote IP Address	<input type="text" value="Any"/> Edit
DiffServ CodePoint	<input type="text" value="ANY"/> ▾
Service Type	<input type="text" value="---Predefined---"/> ▾
QoS Class	<input type="text" value="Class 1"/> ▾

[OK](#) [Delete](#) [Cancel](#)

Available settings are explained as follows:

Item	Description
Enable	Select to enable this rule.
IP Version	Protocol (IPv4 or IPv6) to which this rule applies.
Local IP Address	Click the Edit button to set the local (LAN) IP address or address range for the rule.
DiffServ CodePoint	DSCP or ToS precedence of packets to which this rule applies.

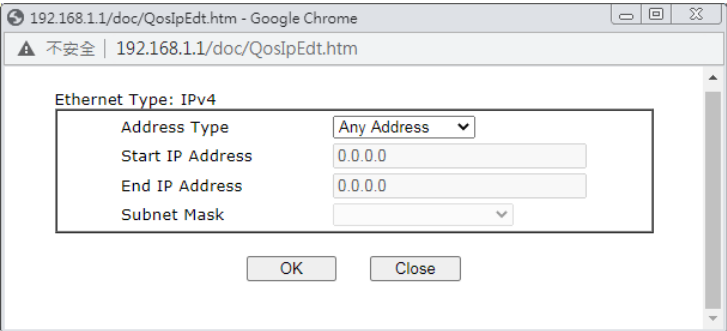
Remote IP Address	<p>Click the Edit button to set the remote (WAN) IP address or address range for the rule.</p>  <p>Address Type - Type of address: Any Address, Single Address, Range Address, Subnet Address.</p> <ul style="list-style-type: none"> ● Single Address - Specify IP address. ● Range Address - Specify Start IP Address and End IP Address. ● Subnet Address - Specify Start IP Address and Subnet Mask.
Service Type	<p>Service Type to which this rule applies.</p> <p>Service is a predefined or user-defined type of traffic that uses certain protocols or ports. To set up a custom service, select User Defined to set the service name, the protocol, and port number.</p>
QoS Class	Specify the QoS class (1, 2 or 3) for this rule.

3. After finishing all the settings here, please click **OK** to save the configuration.

Bandwidth Management >> Quality of Service

[Set to Factory Default](#)

General Setup												
Index	Enable	Direction	Inbound/ Outbound Bandwidth				Class 1	Class 2	Class 3	Others	Status	
WAN1	<input type="checkbox"/>	BOTH	100	Mbps	100	Mbps	25 %	25 %	25 %	25 %	Status	
WAN3	<input type="checkbox"/>	BOTH	100	Mbps	100	Mbps	25 %	25 %	25 %	25 %	Status	
WAN5	<input type="checkbox"/>	BOTH	100	Mbps	100	Mbps	25 %	25 %	25 %	25 %	Status	
WAN6	<input type="checkbox"/>	BOTH	100	Mbps	100	Mbps	25 %	25 %	25 %	25 %	Status	
WAN7	<input type="checkbox"/>	BOTH	100	Mbps	100	Mbps	25 %	25 %	25 %	25 %	Status	
WAN8	<input type="checkbox"/>	BOTH	100	Mbps	100	Mbps	25 %	25 %	25 %	25 %	Status	

Note:
QoS may not work properly if the bandwidth entered is not correct. Before enable QoS, you may run speed test (from e.g., <http://speedtest.net>) or contact your ISP for the accurate bandwidth.

Class Rule

Index	Enable	QoS Class	Local Address	Remote Address	DSCP	Service Type
1	<input checked="" type="checkbox"/>	Class1	Any	Any	ANY	ANY

Note:
1. The packets that don't match any class rules above will be classified into 'Others'
2. Go to [User Defined Service Type](#) to edit/delete user-defined service type profiles.

Retag the Packets for Identification

Packets originating from the LAN that are destined for the WAN can have the DS flag changed to a different value by enabling Tag Packet and specifying the DSCP or IP Precedence value.

In the following illustration, outbound VoIP packets from the LAN arrive at the Vigor router with the QoS value unset. The router sets the DSCP value to AF before forwarding them to the ISP server via the WAN interface.

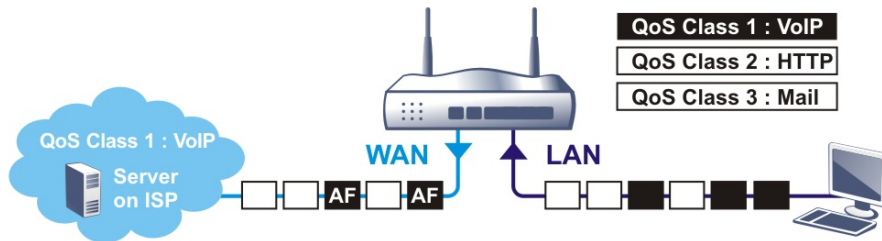

Class Rule

Index	Enable	Qos Class	Local Address	Remote Address	DSCP	Service Type
1	<input checked="" type="checkbox"/>	Class 1	Any	Any	ANY	SIP(UDP:5060)
2	<input checked="" type="checkbox"/>	Class 2	Any	Any	ANY	HTTP(TCP:80)
3	<input checked="" type="checkbox"/>	Class 3	Any	Any	ANY	SMTP(TCP:25)

Note:

The packets that don't match any class rules above will be classified into 'Others'

VoIP Prioritization

Enable the First Priority for VoIP SIP/RTP:

SIP UDP Port: (Default:5060)

Tag Outbound Traffic

- | | | | |
|---------|--------------------------|------------------------------|---------|
| Class 1 | <input type="checkbox"/> | Add DSCP or Precedence Value | Default |
| Class 2 | <input type="checkbox"/> | Add DSCP or Precedence Value | Default |
| Class 3 | <input type="checkbox"/> | Add DSCP or Precedence Value | Default |

V-2-4 APP QoS

To configure APP QoS, from the main menu, select **Bandwidth Management** menu, then click **APP QoS** to bring up the configuration page.

Bandwidth Management >> APP QoS

APP QoS

Enable Disable

Traceable Untraceable

 Apply to all: QoS Class 1 (High) ▼

Enable	Instant Message	Version	Action
<input type="checkbox"/>	Facebook/Instagram		QoS Class 1 (High) ▼
<input type="checkbox"/>	LINE	5.23.0.2134	QoS Class 1 (High) ▼
<input type="checkbox"/>	LinkedIn		QoS Class 1 (High) ▼
<input type="checkbox"/>	Signal	1.26.2	QoS Class 1 (High) ▼
<input type="checkbox"/>	Slack	4.0.0	QoS Class 1 (High) ▼
<input type="checkbox"/>	Snapchat	10.79.5.0	QoS Class 1 (High) ▼
<input type="checkbox"/>	Telegram	1.7.10	QoS Class 1 (High) ▼
<input type="checkbox"/>	WhatsApp	0.3.2848	QoS Class 1 (High) ▼

Enable	VoIP	Version	Action
<input type="checkbox"/>	Skype/Teams	8.66.0.77/4.7.15.0	QoS Class 1 (High) ▼
<input type="checkbox"/>	WeChat	2.7.1	QoS Class 1 (High) ▼

Enable	Protocol	Version	Action
<input type="checkbox"/>	BGP	4	QoS Class 1 (High) ▼
<input type="checkbox"/>	DNS		QoS Class 1 (High) ▼

Available settings are explained as follows:

Item	Description
Enable/Disable	Enables or disables the APP QoS feature.
Traceable	<p>Traceable applications are those whose traffic can be 100% traced.</p> <p>All protocols under this tab can have a specific QoS class assigned.</p> <p>Enable - Select to enable QoS for the application.</p> <p>Apply to all - Select a QoS class to be applied to all protocols. You can override the QoS class for specific protocols using the Action dropdown listbox.</p>
Untraceable	<p>Untraceable applications are detected when they attempt to establish connections to remote hosts, and all traffic between the remote hosts and the local network will be placed under QoS, within the same QoS class.</p> <p>All protocols under this tab can have a specific QoS class assigned.</p> <p>Enable - Select to enable QoS for the application.</p> <p>Action - Select a QoS class to be applied to all applications.</p>
Select All	Click to select all Enabled checkboxes.
Clear All	Click to deselect all Enabled checkboxes.

After changes have been made, click **OK** to save changes, or **Cancel** to discard.

V-3 User Management

User Management is a security feature which disallows any IP traffic (except DHCP-related packets) from a particular host until that host has correctly supplied a valid username and password. Instead of managing with IP address/MAC address, User Management function manages hosts with user account. Network administrator can give different firewall policies or rules for different hosts with different User Management accounts. This is more flexible and convenient for network management. Not only offering the basic checking for Internet access, User Management also provides additional firewall rules, e.g. CSM checking for protecting hosts.

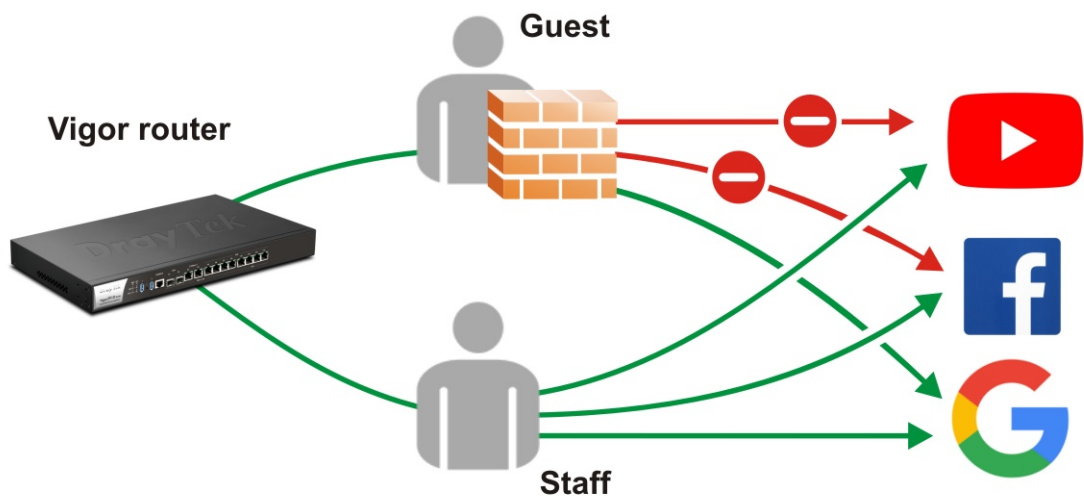

Info

Filter rules configured under Firewall usually are applied to the host (the one that the router installed) only. With user management, the rules can be applied to every user connected to the router with customized profiles.

Web User Interface

- Firewall
- User Management**
 - General Setup
 - User Profile
 - User Group
 - User Online Status
 - PPPoE User Online Status
- Objects Setting

V-3-1 General Setup

General Setup can determine the standard (rule-based or user-based) for the users controlled by User Management. The mode (standard) selected here will influence the contents of the filter rule(s) applied to every user.

User Management >> General Setup

General Setup

Mode Selection:

Rule-Based is a management method based on IP address. Administrator may set different firewall rules to different IP address.

User-Based is a management method based on user profiles. Administrator may set different firewall rules to different user profiles.

Authentication page:

Web Authentication: HTTPS HTTP

Login Page Greeting

Display IP address on the dialog box pops up after successful login.

Landing page:

(Max 255 characters) [Preview](#) | [Set to Factory Default](#) |

```
<body stats=1><script> window.location='https://www.draytek.com'</script></body>
```

OK Clear Cancel

Available settings are explained as follows:

Item	Description
Mode Selection	<p>There are two modes offered here for you to choose. Each mode will bring different filtering effect to the users involved.</p> <p>User-Based - If you choose such mode, the router will apply the filter rules configured in User Management>>User Profile to the users.</p> <p>Rule-Based -If you choose such mode, the router will apply the filter rules configured in Firewall>>General Setup and</p>

	Filter Rule to the users.
Authentication page	<p>Web Authentication - Choose the protocol for web authentication.</p> <p><u>Login Page Greeting</u> - Such link allows you to access into the setting page for login greeting. For detailed information, refer to System Maintenance>>Login Page Greeting.</p> <p>Display IP Address on tracking window - Check the box to display the IP address of the client on the tracking window.</p>
Landing Page	Type the information to be displayed on the first web page when the LAN user accessing into Internet via such router.

After finishing all the settings here, please click **OK** to save the configuration.

V-3-2 User Profile

This page allows you to set customized profiles (up to 200) which will be applied for users controlled under **User Management**. Simply open **User Management>>User Profile**.

User Management >> User Profile

User Profile Table | [Set to Factory Default](#) |

Select All

Profile	Enable	Name	Profile	Enable	Name
1.	<input checked="" type="checkbox"/>	admin	17.	<input type="checkbox"/>	
2.	<input checked="" type="checkbox"/>	Dial-In User	18.	<input type="checkbox"/>	
3.	<input checked="" type="checkbox"/>	james	19.	<input type="checkbox"/>	
4.	<input type="checkbox"/>		20.	<input type="checkbox"/>	
5.	<input type="checkbox"/>		21.	<input type="checkbox"/>	
6.	<input type="checkbox"/>		22.	<input type="checkbox"/>	
7.	<input type="checkbox"/>		23.	<input type="checkbox"/>	
8.	<input type="checkbox"/>		24.	<input type="checkbox"/>	
9.	<input type="checkbox"/>		25.	<input type="checkbox"/>	
10.	<input type="checkbox"/>		26.	<input type="checkbox"/>	
11.	<input type="checkbox"/>		27.	<input type="checkbox"/>	
12.	<input type="checkbox"/>		28.	<input type="checkbox"/>	
13.	<input type="checkbox"/>		29.	<input type="checkbox"/>	
14.	<input type="checkbox"/>		30.	<input type="checkbox"/>	
15.	<input type="checkbox"/>		31.	<input type="checkbox"/>	
16.	<input type="checkbox"/>		32.	<input type="checkbox"/>	

<< [1-32](#) | [33-64](#) | [65-96](#) | [97-128](#) | [129-160](#) | [161-192](#) | [193-200](#) >> [Next](#) >>

Note:

1. admin: To change the administrator password, please go to System Maintenance >> Administrator Password.
2. Dial-In User Profile: Dial-In User Profile is reserved for VPN authentication.
3. During authentication, Router will check all the local user profiles first, and then the profiles in external servers.

To set the user profile, please click any index number link to open the following page. Notice that profile 1 (**admin**) and profile 2 (**Dial-In User**) are factory default settings. Profile 2 is reserved for future use.

User Management >> User Profile

Profile Index 3

Common Settings

Enable this account

Username (Only support A-Z a-z 0-9 _ - . @)

Password

Confirm Password

External Server Authentication

Login Settings

User Online Status : Block/ Unblock

Allow Authentication via Web Alert Tool Telnet

Show Landing Page After Login

Idle Timeout min. (0: Unlimited)

Auto Logout After min. (0: Off)

Pop up Time-Tracking Window

Login Permission Schedule , , ,

Policy

Max. Login Devices (0: Unlimited)

Enable Time Quota 0 min. min.

Enable Data Quota 0 MB MB

Reset Quota Automatically To Time Limit min. Data Limit MB

When Login Permission Schedule Ends
 Schedule Starts

PPPoE Login Settings

PPPoE User Online Status

Reset User Online Status

PPPoE MAC Bind Enable Disable

MAC Address : : : : :

DHCP From

Static IP Address (optional)

Other Services

Allow this profile to be used by Internal RADIUS Local 802.1X

Log

Available settings are explained as follows:

Item	Description
Common Settings	<p>Enable this account - Check this box to enable such user profile.</p> <p>Username - Type a name for such user profile (e.g., LAN_User_Group_1, WLAN_User_Group_A, WLAN_User_Group_B, etc). When a user tries to access Internet through this router, an authentication step must be performed first. The user has to type the User Name specified here to pass the authentication. When the user passes the authentication, he/she can access Internet via this router. However the accessing operation will be</p>

	<p>restricted with the conditions configured in this user profile. The maximum length of the name you can set is 24 characters.</p> <p>Password - Type a password for such profile (e.g., <i>lug123</i>, <i>wug123</i>, <i>wug456</i>, etc). When a user tries to access Internet through this router, an authentication step must be performed first. The user has to type the password specified here to pass the authentication. When the user passes the authentication, he/she can access Internet via this router with the limitation configured in this user profile. The maximum length of the password you can set is 24 characters.</p> <p>Confirm Password - Type the password again for confirmation.</p> <p>External Service Authentication - The router will authenticate the dial-in user by itself or by external service such as LDAP server or RADIUS server or TACACS+ server. If LDAP, Radius or TACACS+ is selected here, it is not necessary to configure the password setting above.</p>
<p>Login Settings</p>	<p>Allow Authentication via- Any user (from LAN side or WLAN side) tries to connect to Internet via Vigor router must be authenticated by the router first. There are three ways offered by the router for the user to choose for authentication.</p> <ul style="list-style-type: none"> ● Web - If it is selected, the user can type the URL of the router from any browser. Then, a login window will be popped up and ask the user to type the user name and password for authentication. If succeed, a Welcome Message (configured in User Management >> General Setup) will be displayed. After authentication, the destination URL (if requested by the user) will be guided automatically by the router. ● Alert Tool - If it is selected, the user can open Alert Tool and type the user name and password for authentication. A window with remaining time of connection for such user will be displayed. Next, the user can access Internet through any browser on Windows. Note that Alert Tool can be downloaded from DrayTek web site. ● Telnet - If it is selected, the user can use Telnet command to perform the authentication job. <p>Show Landing Page After Login - When a user tries to access into the web user interface of Vigor router series with the user name and password specified in this profile, he/she will be lead into the web page configured in Landing Page field in User Management>>General Setup. Check this box to enable such function.</p> <p>Idle Timeout - If the user is idle over the limitation of the timer, the network connection will be stopped for such user. By default, the Idle Timeout is set to 10 minutes.</p> <p>Auto Logout After - Such account will be forced to logout after a certain time set here.</p> <p>Pop up Time-Tracking Window - If such function is enabled, a pop up window will be displayed on the screen with time remaining for connection if Idle Timeout is set. However, the system will update the time periodically to keep the connection always on. Thus, Idle Timeout will not interrupt</p>

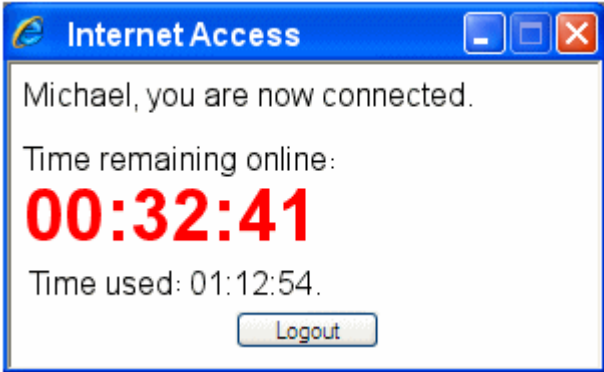
	<p>the network connection.</p> <p>Login Permission Schedule - You can type in four sets of time schedule for your request. All the schedules can be set previously in Application >> Schedule web page and you can use the number that you have set in that web page.</p>
<p>Policy</p>	<p>Max Login Devices - Such profile can be used by many users. You can set the limitation for the number of users accessing Internet with the conditions of such profile. The default setting is 0 which means no limitation in the number of users.</p> <p>Enable Time Quota - Time quota means the total connection time allowed by the router for the user with such profile. Check the box to enable the function of time quota. The first box displays the remaining time of the network connection. The second box allows to type the number of time (unit is minute) which is available for the user (using such profile) to access Internet.</p> <p><input type="button" value="+"/> - Click this box to set and increase the time quota for such profile.</p> <p><input type="button" value="-"/> - Click this box to decrease the time quota for such profile.</p> <p>Note: A dialog will be popped up to notify how many time remained when a user accesses into Internet through Vigor router successfully.</p> <p>When the time is up, all the connection jobs including network, IM, social media, facebook, and etc. will be terminated.</p>  <p>Enable Data Quota - Data Quota means the total amount for data transmission allowed for the user. The unit is MB/GB.</p> <p><input type="button" value="+"/> - Click this box to set and increase the data quota for such profile.</p> <p><input type="button" value="-"/> - Click this box to decrease the data quota for such profile.</p> <p>Reset Quota Automatically To - Set default time quota and data quota for such profile. When the scheduling time is up, the router will use the default quota settings automatically. Check it to use the default setting for time quota and data quota.</p> <ul style="list-style-type: none"> ● Time Limit - Type the value for the time manually. ● Data Limit - Type the value for the data manually. <p>Login Permission Schedule Ends - When the scheduling time is up, the router will reset the quota with user-defined</p>

	<p>time/data values automatically.</p> <p>Schedule - The router will reset the quota with user-defined time/data values at the starting time configured in the selected schedule profile.</p>
<p>PPPoE Login Setting</p>	<p>Such user account will be used (1) by the client with the IP address specified or (2) by the client with the MAC address bound with the IP address, for accessing into Vigor3912 web user interface.</p> <p>PPPoE MAC Bind - Specify a MAC address which is limited and used for such PPPoE account.</p> <ul style="list-style-type: none"> ● Enable/Disable - Click it to enable/disable the function of PPPoE MAC Bind. <p>MAC Address - Type the MAC address to be bound with the IP address set below if PPPoE MAC Bind is enabled.</p> <p>DHCP From - Use the drop down list to specify LAN/DMZ interface. The IP address for binding with the MAC address (above) set in the selected interface will be assigned from the IP address set in the selected interface.</p> <p>Static IP Address (optional)- Type an IP address.</p>
<p>Other Services</p>	<p>Allow this profile to be used by - This option is available for profiles with index number 3 to 200.</p> <ul style="list-style-type: none"> ● Internal RADIUS- Check the box to enable security authenticated via internal RADIUS server. ● Local 802.1X - Check the box to enable security authenticated via internal 802.1X server. <p>Log - Activities of the user can be recorded by Syslog.</p> <ul style="list-style-type: none"> ● None - Logging is disabled. ● Login - Login and logout activities are logged. ● Event - Allowed and blocked traffic are logged. ● All - Both Login and Event types are logged.

After finishing all the settings here, please click **OK** to save the configuration.

V-3-3 User Group

This page allows you to bind several user profiles into one group. These groups will be used in Firewall>>General Setup as part of filter rules.

User Management >> User Group

User Group Table: [Set to Factory Default](#)

Index	Name	Index	Name
1.		17.	
2.		18.	
3.		19.	
4.		20.	
5.		21.	
6.		22.	
7.		23.	
8.		24.	
9.		25.	
10.		26.	
11.		27.	
12.		28.	
13.		29.	
14.		30.	
15.		31.	
16.		32.	

Please click any index number link to open the following page.

User Management >> User Group

Group Index : 1

Name:

Available User Objects

- 1-admin
- 2-Dial-In User
- 3-allen391U

Selected User Objects (Up to 32)

Default object -
1 and 2

User defined
object - others

Available settings are explained as follows:

Item	Description
Name	Type a name for this user group.
Available User Objects	You can gather user profiles (objects) from User Profile page within one user group. All the available user objects that you have created will be shown in this box. Notice that user object, Admin and Dial-In User are factory settings. User defined profiles will be numbered with 3, 4, 5 and so on.

Selected Keyword Objects	Click <input type="button" value="»»"/> button to add the selected user objects in this box.
--------------------------	--

After finishing all the settings here, please click OK to save the configuration.

V-3-4 User Online Status

This page displays the user(s) connected to the router and refreshes the connection status in an interval of several seconds.

User Management >> User Online Status

Current Time : 12-30 08:19:43 Refresh Seconds: Page: | [All Users](#) | [Online Users](#) | [Refresh](#)

Index	User	IP Address	Profile	Last Login Time	Expired Time	Data Quota	Idle Time	Action
1	admin	59.126.213.212	admin	12-30 07:14:05	Unlimited	Unlimited	Unlimited	Block Logout Delete

Note:

- Please click "IP Address" to view all online users.
- Dial-in User profiles are linked to VPN clients and therefore cannot be logged-out or deleted while connecting.
- Information about 802.1X authentication can be found at [Authentication User List](#).

Total Number : 1

Available settings are explained as follows:

Item	Description
Refresh Seconds	Use the drop down list to choose the time interval of refreshing data flow that will be done by the system automatically.
Refresh	Click this link to refresh this page manually.
Index	Display the number of the data flow.
User	Display the users which connect to Vigor router currently. You can click the link under the username to open the user profile setting page for that user.
IP Address	Display the IP address of the device.
Profile	Display the authority of the account.
Last Login Time	Display the login time that such user connects to the router last time.
Expired Time	Display the expired time of the network connection for the user.
Data Quota	Display the quota for data transmission.
Idle Time	Display the idle timeout setting for such profile.

Action	Block - can avoid specified user accessing into Internet. Unblock - allow the user to access into Internet. Logout - the user will be logged out forcefully.
--------	---

V-3-5 PPPoE User Online Status

PPPoE User Online Status displays connection information (including IP address, MAC address, user name, transmitted bytes, received bytes, up time and so on) for the LAN client who accesses Internet via the built-in PPPoE server of Vigor router.

User Management >> PPPoE User Online Status

PPPoE User Online Status Refresh Seconds: | [Refresh](#) |

Index	IP Address	MAC Address	User Name	Rx Bytes	Tx Bytes	Up Time

Total Number : 0

Available settings are explained as follows:

Item	Description
Refresh Seconds	Use the drop down list to choose the time interval of refreshing data flow that will be done by the system automatically.
Refresh	Click this link to refresh this page manually.
IP Address	Displays the IP address of the client in LAN.
MAC Address	Displays the MAC address of the client in LAN.
User Name	Displays the name of user connecting to Vigor router currently. You can click the link under the username to open the user profile setting page for that user.
Rx Bytes	Displays the speed of octets received through such PPPoE user.
Tx Bytes	Displays the speed of octets transmitted through such PPPoE user.
Up Time	Displays the connection time of such PPPoE user.

Application Notes

A-1 How to authenticate clients via User Management

Before using the function of User Management, please make sure **User-Based** has been selected as the **Mode** in the **User Management>>General Setup** page.

User Management >> General Setup

General Setup

Mode Selection:

Rule-Based is a management method based on IP address. Administrator may set different firewall rules to different IP address.

User-Based is a management method based on user profiles. Administrator may set different firewall rules to different user profiles.

Notice for User-Based mode:

- In User-Based mode, **Active Rules** in Firewall will be applied to all LAN clients, packets that matches the Active Rules will be blocked or pass immediately, no user authentication is required.
- Only **Inactive Rules** in Firewall can be set for individual user profile. In User-Based

With **User Management** authentication function, before a valid username and password have been correctly supplied, a particular client will not be allowed to access Internet through the router. There are three ways for authentication: **Web**, **Alert Tool** and **Telnet**.

User Management >>User Profile

Profile Index 3

Common Settings

Enable this account

Username (Only support A-Z a-z 0-9 - . @)

Password

Confirm Password

External Server Authentication

Login Settings

Allow Authentication via Web Alert Tool Telnet

Show Landing Page After Login

Idle Timeout min. (0: Unlimited)

Auto Logout After min. (0: Off)

Authentication via Web

- If a LAN client who hasn't passed the authentication opens an external web site in his browser, he will be redirected to the router's Web authentication interface first. Then, the client is trying to access <http://www.draytek.com> and but brought to the Vigor router. Since this is an SSL connection, some web browsers will display warning messages.
 - With Microsoft Internet Explorer, you may get the following warning message. Please press **Continue to this website (not recommended)**.

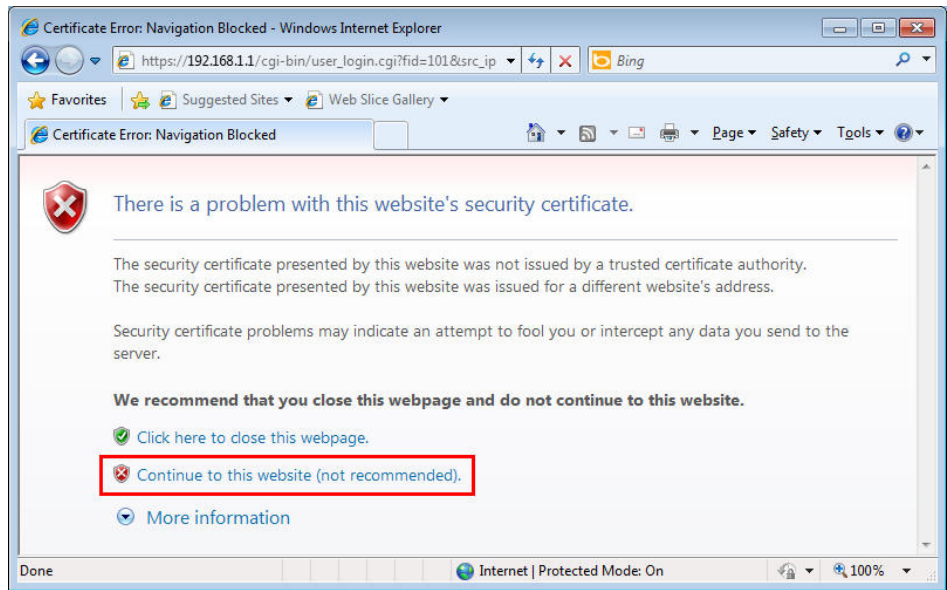

- With Mozilla Firefox, you may get the following warning message. Select **Understand the Risks**.

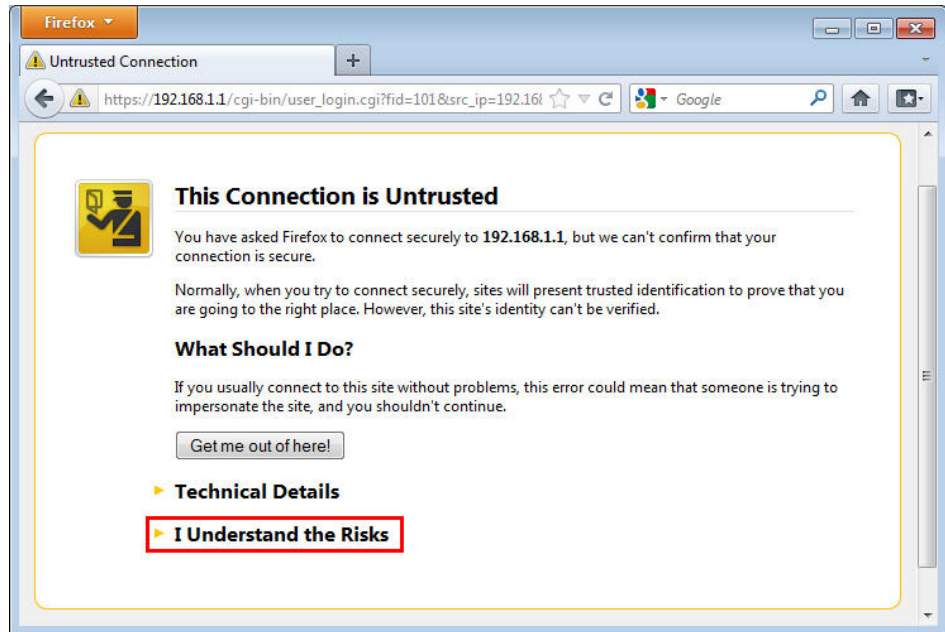

- With Chrome browser, you may get the following warning. Click Proceed anyway.

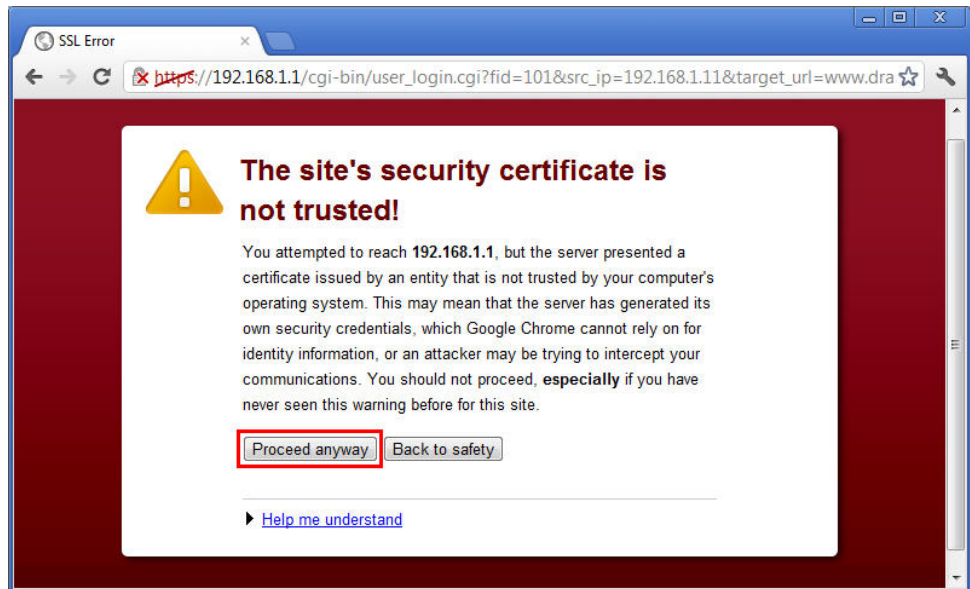

After that, the web authentication window will appear. Input the user name and the password for your account (defined in User Management) and click Login.

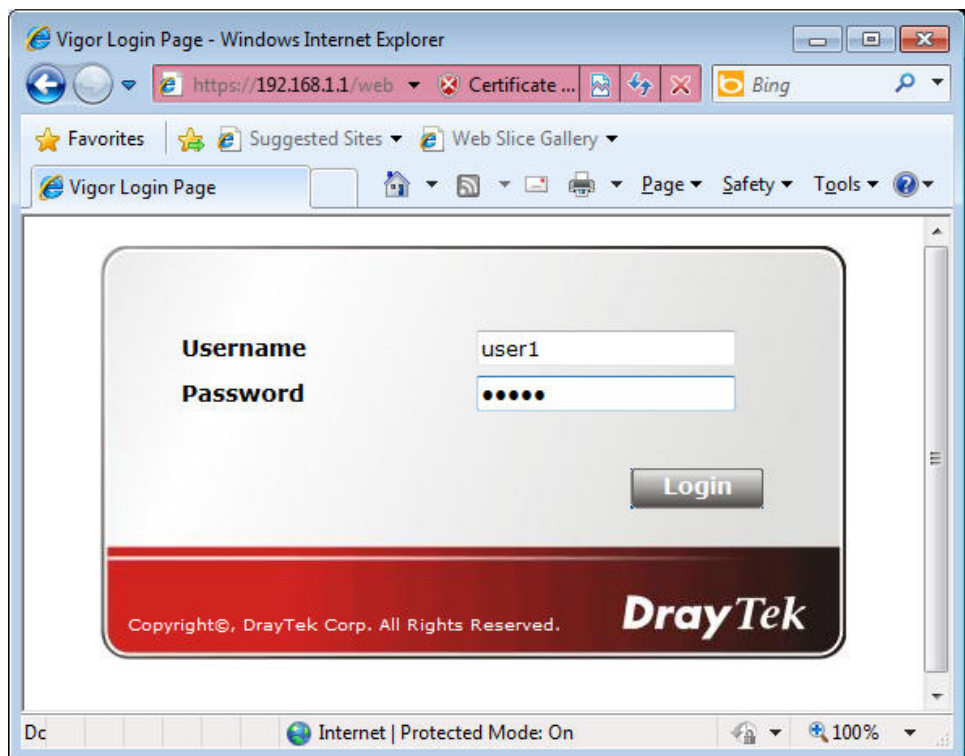

If the authentication is successful, the client will be redirected to the original web site that he tried to access. In this example, it is <http://www.draytek.com> . Furthermore, you will get a popped up window as the following. Then you can access the Internet.

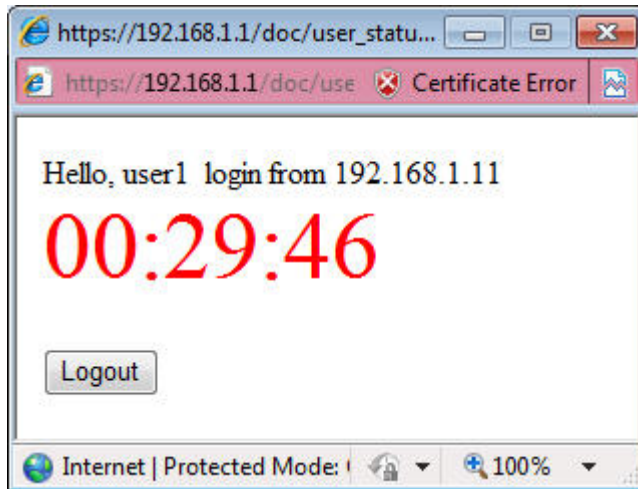

Note, if you block the web browser to pop up any window, you will not see such window. If the authentication is failed, you will get the error message, **The username or password you entered is incorrect. Please login again.**

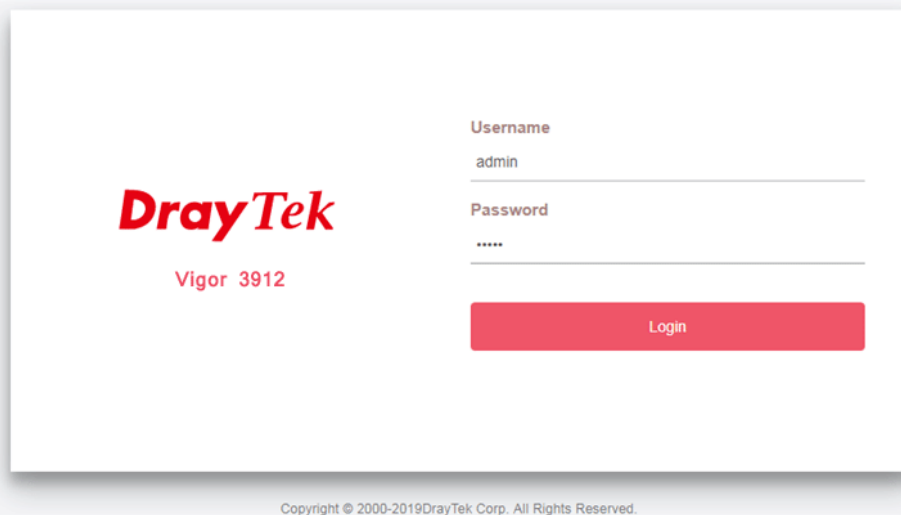

- In above description, you access an external web site to trigger the authentication. You may also directly access the router's Web UI for authentication. Both HTTP and HTTPS are supported, for example <http://192.168.1.1> or <https://192.168.1.1> . Replace 192.168.1.1 with your router's real IP address, and add the port number if the default management port has been modified.

If the authentication is successful, you will get the **Welcome Message** that is set in the **User Management >> General Setup** page.

General Setup

Mode Selection:

Rule-Based is a management method based on IP address. Administrator may set different firewall rules to different IP address.

User-Based is a management method based on user profiles. Administrator may set different firewall rules to different user profiles.

Notice for User-Based mode:

- In User-Based mode, **Active Rules** in Firewall will be applied to all LAN clients, packets that matches the Active Rules will be blocked or pass immediately, no user authentication is required.
- Only **Inactive Rules** in Firewall can be set for individual user profile. In User-Based mode, packets that do not match Active Rules will need authentication, and the Inactive Rule applied to the specific user profile will then take effect.

Authentication page:

Web Authentication: HTTPS HTTP

With the default setup `<body stats=1><script language='javascript'>window.location='http://www.draytek.com'</script></body>`, you will be redirected to `http://www.draytek.com`. You may change it if you want. For example, you will get the following welcome message if you enter **Login Successful** in the **Welcome Message** table.

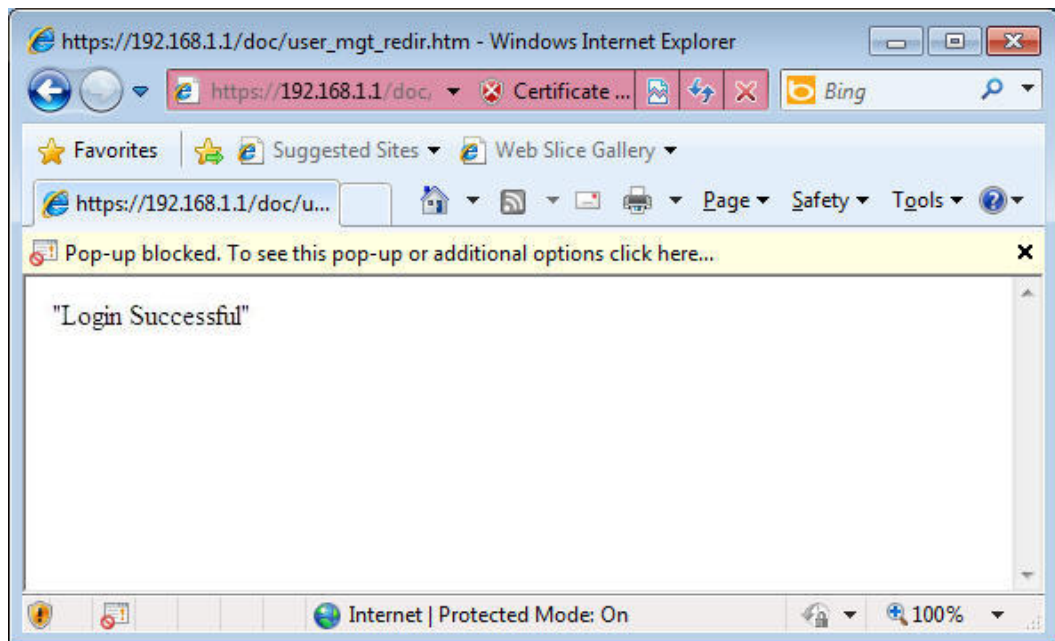

Also you will get a **Tracking Window** if you don't block the pop-up window.

- Don't setup a user profile in **User Management** and a **VPN Remote Dial-in** user profile with the same Username. Otherwise, you may get unexpected result. It is because the **VPN Remote Dial-in** User profiles can be extended to the User profiles in **User Management** for authentication.

There are two different behaviors when a **User Management** account and a **VPN** profile share the same Username:

- If **SSL Tunnel** or **SSL Web Proxy** is enabled in the **VPN** profile, the user profile in **User Management** will always be invalid for **Web authentication**. For example, if you create a user profile in **User Management** with **chaochen/test** as username/password, while a **VPN Remote Dial-in** user profile with the same username "chaochen" but a different password "1234", you will always get error message **The username or password you entered is incorrect** when you use **chaochen/test** via **Web** to do authentication.

Index No. 1

<input checked="" type="checkbox"/> Enable this Account <input checked="" type="checkbox"/> Multiple Concurrent Connections Allowed Idle Timeout: <input type="text" value="300"/> second(s)	User Account and Authentication Username: <input type="text" value="???"/> Password: <input type="text" value=""/> <input type="checkbox"/> Enable Mobile One-Time Passwords(mOTP) <input type="checkbox"/> Enable Time-based One-time Password(TOTP) <input type="button" value="Regenerate"/>
Allowed Dial-In Type <input type="checkbox"/> PPTP <input checked="" type="checkbox"/> IPsec Tunnel <input checked="" type="checkbox"/> IKEv1/IKEv2 <input checked="" type="checkbox"/> IKEv2 EAP <input checked="" type="checkbox"/> IPsec XAuth <input checked="" type="checkbox"/> L2TP with IPsec Policy: <input type="text" value="None"/> <input checked="" type="checkbox"/> SSL Tunnel <input checked="" type="checkbox"/> OpenVPN Tunnel <input type="checkbox"/> WireGuard	IKE Authentication Method <input checked="" type="checkbox"/> Pre-Shared Key IKE Pre-Shared Key: <input type="text" value=""/> <input type="checkbox"/> Digital Signature(X.509) <input type="text" value="None"/>
<input type="checkbox"/> Specify Remote Node Remote Client: <input checked="" type="radio"/> IP <input type="radio"/> Domain Name <input type="text" value=""/> or Peer ID: <input type="text" value=""/> Netbios Naming Packet: <input checked="" type="radio"/> Pass <input type="radio"/> Block Multicast via VPN: <input type="radio"/> Pass <input checked="" type="radio"/> Block (for some IGMP,IP-Camera,DHCP Relay..etc.)	IPsec Security Method <input checked="" type="checkbox"/> Medium(AH) High(ESP): <input checked="" type="checkbox"/> DES <input checked="" type="checkbox"/> 3DES <input checked="" type="checkbox"/> AES Local ID (optional): <input type="text" value=""/>
Subnet <input type="text" value="LAN 1"/> <input type="checkbox"/> Assign Static IP Address: <input type="text" value="0.0.0.0"/>	WireGuard Peer Setting <input type="button" value="Client Config Generator"/> Public key: <input type="text" value=""/> Pre-shared key: <input type="text" value="optional"/> Persistent keepalive: <input type="text" value="60"/> second(s)
	Schedule Profile <input type="text" value="None"/> , <input type="text" value="None"/> , <input type="text" value="None"/> , <input type="text" value="None"/>
	Notification: <input type="text" value=""/>

- If SSL Tunnel or SSL Web Proxy is disabled in the VPN profile, a User Management account and a remote dial-in VPN profile can use the same Username, even with different passwords. However, we recommend you to use different usernames for different user profiles in User Management and VPN profiles.

Authentication via Telnet

The LAN clients can also authenticate their accounts via telnet.

1. Telnet to the router's LAN IP address and input the account name for the authentication:



2. Type the password for authentication and press Enter. The message User login successful will be displayed with the expired time (if configured).

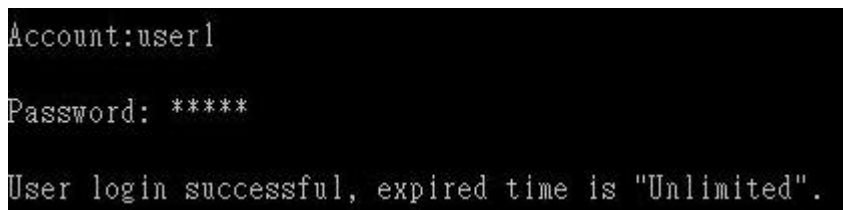

Info

Here expired time is "Unlimited" means the Time Quota function is not enabled for this account. After login, this account will not be expired until it is logout.

3. In the Web interface of router, the configuration page of Time Quota is shown as below.

User Management >> User Profile

Profile Index 3

Common Settings

<input checked="" type="checkbox"/> Enable this account	
Username	<input type="text" value="user1"/> (Only support A-Z a-z 0-9 _ - . @)
Password	<input type="password" value="*****"/>
Confirm Password	<input type="password"/>
External Server Authentication	<input type="text" value="None"/>

Login Settings

Allow Authentication via	<input checked="" type="checkbox"/> Web	<input checked="" type="checkbox"/> Alert Tool	<input checked="" type="checkbox"/> Telnet
Show <u>Landing Page</u> After Login	<input type="checkbox"/>		
Idle Timeout	<input type="text" value="10"/> min. (0: Unlimited)		
Auto Logout After	<input type="text" value="0"/> min. (0: Off)		
Pop up Time-Tracking Window	<input checked="" type="checkbox"/>		
Login Permission <u>Schedule</u>	<input type="text" value="None"/>	<input type="text" value="None"/>	<input type="text" value="None"/>

Policy

Max. Login Devices	<input type="text" value="0"/> (0: Unlimited)		
<input checked="" type="checkbox"/> Enable Time Quota	<input type="text" value="0"/> min.	<input type="text" value="0"/>	<input type="text" value="0"/>
<input type="checkbox"/> Enable Data Quota	<input type="text" value="0"/> MB	<input type="text" value="0"/>	<input type="text" value="0"/>
<input type="checkbox"/> Reset Quota Automatically To	Time Limit <input type="text" value="0"/> min.	Data Limit <input type="text" value="0"/> MB	
When	<input checked="" type="radio"/> Login Permission Schedule Ends		
	<input type="radio"/> <u>Schedule</u> <input type="text" value="None"/> Starts		

- If the Time Quota is set with "0" minute, you will get the following message which means this account has no time quota.

```
Account:user1
Password: *****
User's time is up, or it has not enough time quota.
```

If the Time Quota is enabled and time is not 0 minute,

User Management >> User Profile

Profile Index 3
Common Settings

<input checked="" type="checkbox"/> Enable this account			
Username	<input type="text" value="user1"/>	(Only support A-Z a-z 0-9 _ - . @)	
Password	<input type="password" value="*****"/>		
Confirm Password	<input type="password"/>		
External Server Authentication	None <input type="button" value="v"/>		

Login Settings

Allow Authentication via	<input checked="" type="checkbox"/> Web	<input checked="" type="checkbox"/> Alert Tool	<input checked="" type="checkbox"/> Telnet
Show <u>Landing Page</u> After Login	<input type="checkbox"/>		
Idle Timeout	<input type="text" value="10"/>	min. (0: Unlimited)	
Auto Logout After	<input type="text" value="0"/>	min. (0: Off)	
Pop up Time-Tracking Window	<input checked="" type="checkbox"/>		
Login Permission <u>Schedule</u>	None <input type="button" value="v"/>	None <input type="button" value="v"/>	None <input type="button" value="v"/>

Policy

Max. Login Devices	<input type="text" value="0"/>	(0: Unlimited)	
<input checked="" type="checkbox"/> Enable Time Quota	0	min.	<input type="text" value="-"/> <input type="text" value="0"/> <input type="button" value="+"/>
<input type="checkbox"/> Enable Data Quota	0	MB <input type="button" value="v"/>	<input type="text" value="-"/> <input type="text" value="0"/> <input type="button" value="+"/>
<input type="checkbox"/> Reset Quota Automatically To	Time Limit <input type="text" value="0"/>	min.	Data Limit <input type="text" value="0"/> MB
When	<input checked="" type="radio"/> Login Permission Schedule Ends <input type="radio"/> <u>Schedule</u> <input type="button" value="None"/> <input type="button" value="v"/> Starts		

You will get the following message. The expired time is shown after you login.

```
Account:user1
Password: *****
User login successful, expired time is "12-23 10:21:33".
```

After you run out the available time, you can't use this account any more until the administrator manually adds additional time for you.

A-2 How to use Landing Page Feature

Landing Page is a special feature configured under User Management. It can specify the message, content to be seen or specify which website to be accessed into when users try to access into the Internet by passing the authentication. Here, we take Vigor3912 Series router as an example.

Example 1 : Users can see the message for landing page after logging into Internet successfully

1. Open the web user interface of Vigor3912.
2. Open **User Management -> General Setup** to get the following page. In the field of **Landing Page**, please type the words of "Login Success". Please note that the maximum number of characters to be typed here is 255.

User Management >> General Setup

General Setup

Mode Selection:

Rule-Based is a management method based on IP address. Administrator may set different firewall rules to different IP address.

User-Based is a management method based on user profiles. Administrator may set different firewall rules to different user profiles.

Notice for User-Based mode:

- In User-Based mode, **Active Rules** in Firewall will be applied to all LAN clients, packets that matches the Active Rules will be blocked or pass immediately, no user authentication is required.
- Only **Inactive Rules** in Firewall can be set for individual user profile. In User-Based mode, packets that do not match Active Rules will need authentication, and the Inactive Rule applied to the specific user profile will then take effect.

Authentication page:

Web Authentication: HTTPS HTTP

Login Page Greeting

Display IP address on the dialog box pops up after successful login.

Landing page:

(Max 255 characters) [Preview](#) | [Set to Factory Default](#) |

```
<body stats=1><script> Login Success </script></body>
```

OK Clear Cancel

3. Now you can enable the **Landing Page** function. Open **User Management -> User Profile** and click one of the index number (e.g., index number 3) links.

User Management >> User Profile

User Profile Table

Profile	Enable	Name	Profile
1.	<input checked="" type="checkbox"/>	admin	17.
2.	<input checked="" type="checkbox"/>	Dial-In User	18.
3.	<input type="checkbox"/>		19.
4.	<input type="checkbox"/>		20.

- In the following page, check the box of **Landing page** and click **OK** to save the settings.

User Management >> User Profile

Profile Index 3
Common Settings

<input checked="" type="checkbox"/> Enable this account	
Username	Caca (Only support A-Z a-z 0-9 - . @)
Password	*****
Confirm Password	
External Server Authentication	None

Login Settings

Allow Authentication via	<input checked="" type="checkbox"/> Web	<input checked="" type="checkbox"/> Alert Tool	<input checked="" type="checkbox"/> Telnet
Show Landing Page After Login	<input checked="" type="checkbox"/>		
Idle Timeout	10 min. (0: Unlimited)		
Auto Logout After	1 min. (0: Off)		
Pop up Time-Tracking Window	<input checked="" type="checkbox"/>		
Login Permission	Schedule	None	None

Policy

Max. Login Devices	0 (0: Unlimited)
<input type="checkbox"/> Enable Time Quota	0 min. - 120 +
<input type="checkbox"/> Enable Data Quota	0 MB - 0 +
<input type="checkbox"/> Reset Quota Automatically To	Time Limit 0 min. Data Limit 0 MB
When	<input checked="" type="radio"/> Login Permission Schedule Ends <input type="radio"/> Schedule None Starts

- Open any browser (e.g., FireFox, Internet Explorer). The logging page will appear and asks for username and password. Please enter the correct username and password.

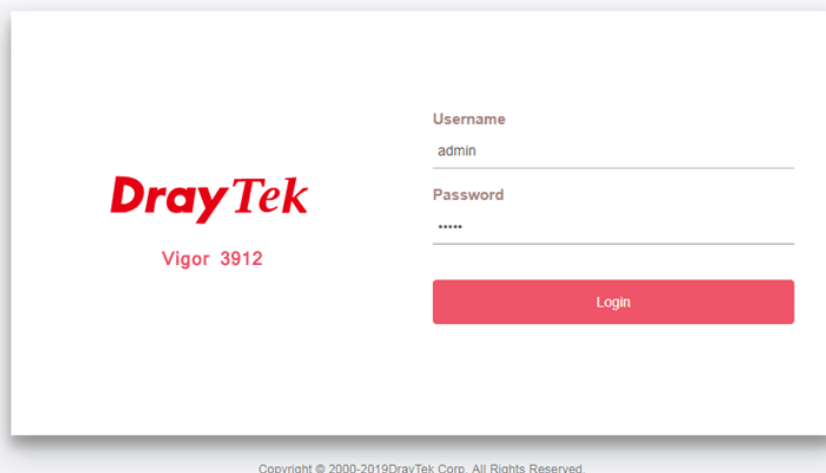

- Click **Login**. If the logging is successful, you will see the message of Login Success from the browser you use.



Example 2 : The system will connect to <http://www.draytek.com> automatically after logging into Internet successfully

1. In the field of **Landing Page**, please type the words as below:

```
" <body stats=1><script language='javascript'>
window.location='http://www.draytek.com'</script></body>"
```

User Management >> General Setup

General Setup

Mode Selection:

Rule-Based is a management method based on IP address. Administrator may set different firewall rules to different IP address.

User-Based is a management method based on user profiles. Administrator may set different firewall rules to different user profiles.

Notice for User-Based mode:

- In User-Based mode, **Active Rules** in Firewall will be applied to all LAN clients, packets that matches the Active Rules will be blocked or pass immediately, no user authentication is required.
- Only **Inactive Rules** in Firewall can be set for individual user profile. In User-Based mode, packets that do not match Active Rules will need authentication, and the Inactive Rule applied to the specific user profile will then take effect.

Authentication page:

Web Authentication: HTTPS HTTP

Login Page Greeting

Display IP address on the dialog box pops up after successful login.

Landing page:

(Max 255 characters) [Preview](#) | [Set to Factory Default](#) |

```
<body stats=1><script language='javascript'>
window.location='http://www.draytek.com'</script></body>
```

2. Next, enable the **Landing Page** function. Open **User Management -> User Profile** and click one of the index number (e.g., index number 3) links.

User Management >> User Profile

User Profile Table

Select All Clear All

Profile	Enable	Name
1.	<input checked="" type="checkbox"/>	admin
2.	<input checked="" type="checkbox"/>	Dial-In User
3.	<input type="checkbox"/>	
4.	<input type="checkbox"/>	

- In the following page, check the box of **Landing page** and click **OK** to save the settings.

User Management >> User Profile

Profile Index 3
Common Settings

<input checked="" type="checkbox"/> Enable this account	
Username	Caca (Only support A-Z a-z 0-9 - . @)
Password	*****
Confirm Password	*****
External Server Authentication	None

Login Settings

Allow Authentication via	<input checked="" type="checkbox"/> Web <input checked="" type="checkbox"/> Alert Tool <input checked="" type="checkbox"/> Telnet
Show Landing Page After Login	<input checked="" type="checkbox"/>
Idle Timeout	10 min. (0: Unlimited)
Auto Logout After	1 min. (0: Off)
Pop up Time-Tracking Window	<input checked="" type="checkbox"/>
Login Permission Schedule	None, None, None, None

Policy

Max. Login Devices	0 (0: Unlimited)
<input type="checkbox"/> Enable Time Quota	0 min. - 0 +
<input type="checkbox"/> Enable Data Quota	0 MB - 0 +
<input type="checkbox"/> Reset Quota Automatically To	Time Limit 0 min. Data Limit 0 MB
When	<input checked="" type="radio"/> Login Permission Schedule Ends <input type="radio"/> Schedule None Starts

- Open any browser (e.g., FireFox, Internet Explorer). The logging page will appear and asks for username and password. Please enter the correct username and password.

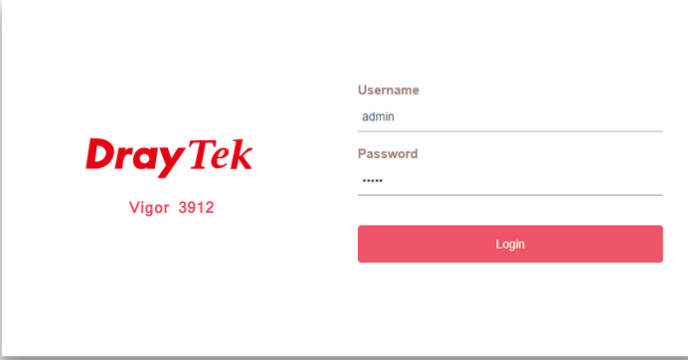

The image shows the login page for a DrayTek Vigor 3912 device. On the left, the DrayTek logo is displayed in red, with 'Vigor 3912' written below it. On the right, there is a login form with two input fields: 'Username' containing 'admin' and 'Password' containing '.....'. Below these fields is a red 'Login' button. At the bottom of the page, there is a small copyright notice: 'Copyright © 2000-2019 DrayTek Corp. All Rights Reserved.'

5. Click **Login**. If the logging is successful, you will be directed into the website of www.draytek.com.

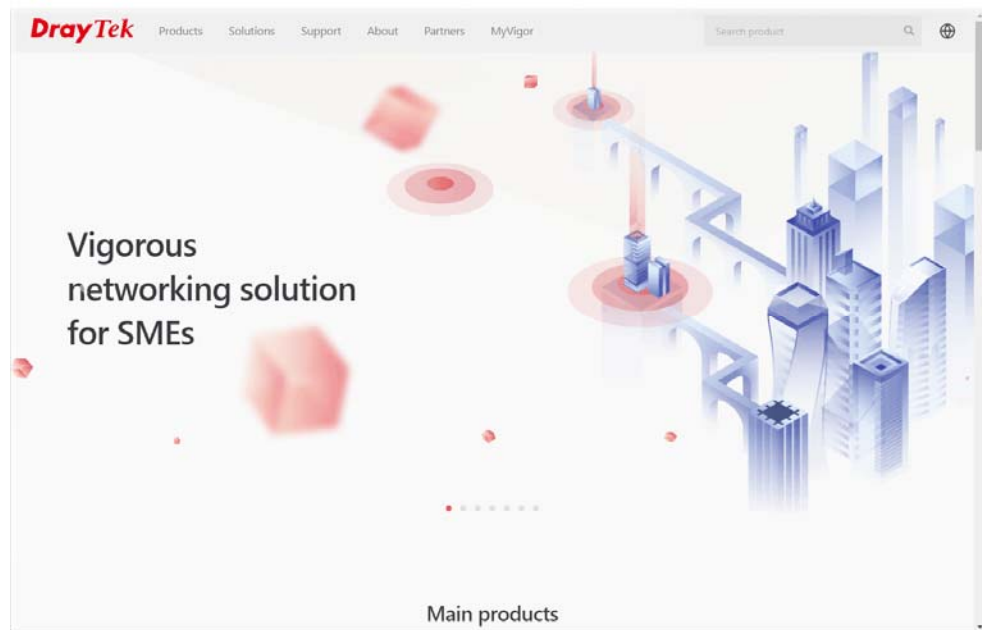

V-4 Hotspot Web Portal

The Hotspot Web Portal feature allows you to set up profiles so that LAN users could either be redirected to specific URLs, or be shown messages when they first attempt to connect to the Internet through the router. Users could be required to read and agree to terms and conditions, or authenticate themselves prior to gaining access to the Internet. Other potential uses include the serving of advertisements and promotional materials, and broadcast of public service announcements.

Web User Interface



V-4-1 Profile Setup

Select **Profile Setup** to create or modify Portal profiles. Up to 4 profiles can be created to meet different requirements according to LAN subnets, WLAN SSIDs, origin and destination IP addresses, etc.

Hotspot Web Portal >> Profile Setup



Hotspot Web Portal Profile:

Index	Enable	Comments	Login Mode	Applied Interface	
1.	<input checked="" type="checkbox"/>	test	Click-through	None	<input type="button" value="Preview"/>
2.	<input type="checkbox"/>		Click-through	None	<input type="button" value="Preview"/>
3.	<input type="checkbox"/>		Click-through	None	<input type="button" value="Preview"/>
4.	<input type="checkbox"/>		Click-through	None	<input type="button" value="Preview"/>

Preview hotspot from WAN and VPN

Note:

1. The router must connect to the Internet before webpage redirection will work.
2. If the LAN clients are using another DNS server on LAN, please make sure the DNS query for domain name "portal.draytek.com" will be resolved by the router.
3. If you want to enable Preview hotspot from WAN and VPN, please set up [Internet Access Control](#).

Backup up <input type="button" value="Profile 1 v"/> : <input type="button" value="Backup"/>	Restore <input type="button" value="選擇檔案"/> 未選擇任何檔案 to <input type="button" value="Profile 1 v"/> : <input type="button" value="Restore"/>
<input type="checkbox"/> Restore Quota Management Setting	

Available settings are explained as follows:

Item	Description
Index	Click the index number link to view or update the profile settings.

Enable	Check the box to enable the profile.
Comments	Shows the description of the profile.
Login Mode	Shows the login mode used by the profile. See the section <i>Login Mode</i> for details.
Applied Interface	Shows the interfaces to which this profile applies.
Preview	Click this button to preview the Hotspot Web Portal page that will be displayed to users.
Backup up	Profile list - Select a source profile. Backup - Click to save the configuration file based on the selected source profile.
Restore ...	Select - Click to choose a configuration file. to.. - Select a destination profile. It will be restored by the selected configuration file. Restore - Click to perform the restoration job. Restore Quota Management Setting - If selected, the quota management setting also will be restored onto the destination profile.

V-4-1-1 Login Method

There are five login methods to choose from for authenticating network clients: **Skip Login**, **Click Through**, **Social Login**, **PIN Login**, and **Social or PIN Login**. Each login mode will present a different web page to users when they connect to the network.

(A) Skip Login, landing page only

This mode does not perform any authentication. The user will be redirected to the landing page. The user can then leave the landing page to visit other websites.

(B) Click-through

The following page will be shown to the users when they first attempt to access the Internet through the router. After clicking **Accept** on the page, users will be directed to the landing page (defined in Captive Portal URL) and be granted access to the Internet.

(C) Various Hotspot Login

An authentication page will appear when users attempt to access the Internet for the first time via the router. After authenticating themselves using a Facebook account, Google account, PIN code, password for RADIUS sever, they will be directed to the landing page and be granted access to the Internet.

(D) External Portal Server

External RADIUS server will authenticate the users when they attempt to access the Internet for the first time via the router.

V-4-1-2 Steps for Configuring a Web Portal Profile

1 Login Method

Click the index link (e.g., #1) of the selected profile to display the following page.

Hotspot Web Portal >> Profile Setup

The screenshot shows the 'Profile Setup' page with five steps: 1. Login Method (highlighted in red), 2. Background, 3. Login Page Setup, 4. Whitelist Setting, and 5. More Options. Below the steps, there is a checkbox for 'Enable this profile' which is checked, and a 'Comments' field containing the text 'test'. The 'Portal Server' section includes a 'Portal Method' dropdown with options: Skip Login, landing page only; Click through; Various Hotspot Login (selected); and External Portal Server. The 'Captive Portal URL' field shows 'http://' and 'portal.draytek.com'. The 'Login Methods' section has a 'Choose Login Method' checkbox and several options: Login with Facebook (with a note about protocol change to HTTPS), Login with Google, Receive PIN via SMS, Receive PIN via Mail, PIN with Voucher, and Login with RADIUS. At the bottom are 'Save and Next' and 'Cancel' buttons.

Available settings are explained as follows:

Item	Description
Enable this profile	Check to enable this profile.
Comments	Enter a brief description to identify this profile.
Portal Server	
Portal Method	There are four methods to be selected as for portal server. <input type="radio"/> Skip Login, landing page only <input type="radio"/> Click through <input checked="" type="radio"/> Various Hotspot Login <input type="radio"/> External Portal Server

When Skip Logging, landing page only or Click through is selected as Portal Method

Captive Portal URL	Enter the captive portal URL.
<i>When Various Hotspot Login is selected as Portal Method</i>	
Captive Portal URL	Enter the captive portal URL.
Login Methods	<p>This setting is available when Various Hotspot Login is selected as the portal method.</p> <p>Choose Login Method - Select one or more desired login methods.</p> <ul style="list-style-type: none"> ● Login with Facebook ● Login with Google ● Receive PIN via SMS ● Receive PIN via Mail ● PIN with Voucher ● Login with RADIUS
Facebook (Login with Facebook)	<p>This setting is available when Login with Facebook is selected as the login method.</p> <p>Facebook APP ID - Enter a valid Facebook developer app ID. If you do not already have an app ID, refer to section A-1 <i>How to create a Facebook App ID for Web Portal Authentication</i> for instructions on obtaining an APP ID.</p> <p>Facebook APP Secret - Enter the secret configured for the APP ID entered above.</p> <p>Refer to section A-1 <i>How to create a Facebook App ID for Web Portal Authentication</i> for details.</p>
Google (Login with Google)	<p>This setting is available when Login with Google is selected as the login method.</p> <p>Google App ID - Enter a valid Google app ID. If you do not already have an app ID, refer to section A-2 <i>How to create a Google App ID for Web Portal Authentication</i> for instructions on obtaining an APP ID.</p> <p>Google App Secret - Enter the secret configured for the APP ID entered above.</p> <p>Refer to section A-2 <i>How to create a Google APP ID for Web Portal Authentication</i> for details.</p>
SMS Provider (Receive PIN via SMS)	<p>This setting is available when Receive PIN via SMS is selected as the login method.</p> <p>Receiving PIN via SMS Provider - Select the SMS Provider used to send PIN notifications SMS providers are configured in Objects Setting >> SMS / Mail Service Object.</p>
Mail Server (Receive PIN via Mail)	<p>This setting is available when Receive PIN via Mail is selected as the login method.</p> <p>Receiving PIN via Mail Server - Select the mail server to send PIN notifications. The mail servers are configured in Objects Setting >> SMS / Mail Service Object.</p>
Radius Server (Login with RADIUS)	<p>This setting is available when Login with RADIUS is selected as the login method.</p> <p>Authentication Method - Click link to configure the external RADIUS server for authenticating web portal clients.</p> <p>RADIUS MAC Authentication - Check Enable to activate user authentication by MAC address.</p> <p>MAC Address Format - Select the MAC address format that is used by the RADIUS server.</p>

	RADIUS NAS-Identifier - It is an attribute of the RADIUS server, used by a client as an identification on a RADIUS server. Enter a string with less than 32 characters.
<i>When External Portal Server is selected as Portal Method</i>	
Captive Portal URL	Enter the captive portal URL.
Redirection URL	Enter the URL to which the client will be redirected.
RADIUS Server	<p>Authentication Method - To configure the RADIUS server, click the External RADIUS Server link and you will be presented with the configuration page.</p> <p>RADIUS MAC Authentication - If the RADIUS server supports authentication by MAC address, enable RADIUS MAC Authentication and select the MAC address format that is used by the RADIUS server.</p> <p>RADIUS NAS-Identifier - It is an attribute of the RADIUS server, used by a client as an identification on a RADIUS server. Enter a string with less than 32 characters.</p>
Save and Next	Click to save the configuration on this page and proceed to the next page.
Cancel	Click to save the configuration on this page and proceed to the next page.

If you have chosen **Skip Login, landing page only** or **External Portal Server** as the portal method, skip to step 4 *Whitelisting* below.

Otherwise, proceed to configure the login page by following steps 2 and 3.

2 Background

If you have selected a Login Mode that requires authentication, select a background for the login page.

Hotspot Web Portal >> Profile Setup

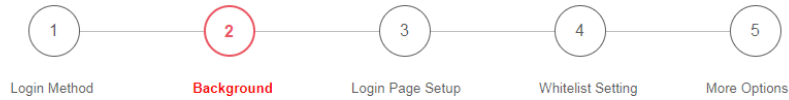

Choose Login Background

Color Background

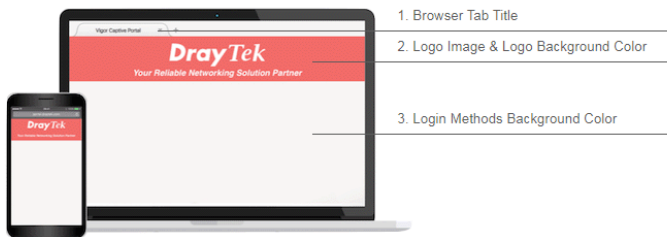
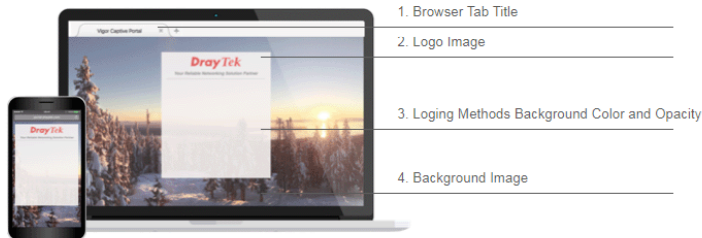

Image Background



Browser Tab Title

Logo Image



Logo Background Color

(format : FFFFFFFF)

Login Method Background Color

(format : FFFFFFFF)

Available settings are explained as follows:

Item	Description
Choose Login Background	Select either Color Background or Image Background as the login page background scheme.
Browser Tab Title	Enter the text to be shown as the webpage title in the browser.
Logo Image	The DrayTek Logo will be displayed by default. However, you can enter HTML text or upload an image to replace the default logo.

Login Method Background Color	Select the background color of the login panel from the predefined color list, or select Customize Color and enter the RGB value. Click Preview to preview the selected color.
Opacity (10 ~ 100)	Available when Image Background is selected. Set the opacity of the background image.
Background Image	Available when Image Background is selected. Click Browse... to select an image file (.JPG or .PNG format), then click Upload to upload it to the router.
Save and Next	Click to save the configuration on this page and proceed to the next page.
Cancel	Click to abort the configuration process and return to the profile summary page.

If you have selected **Skip Login, landing page only** or **External Portal Server** as the portal method, proceed to Step 4 *Whitelist Setting*; otherwise, continue to Step 3 *Login Page Setup*.

3 Login Page Setup

In this step you can configure settings for the login page.

Click Through

This section describes the Login Page setup if you have selected **Click Through** as the Login Method.

Hotspot Web Portal >> Profile Setup

1 — 2 — 3 — 4 — 5

Login Method
Background
Login Page Setup
Whitelist Setting
More Options

Configure Login Method and Details

Welcome!
Please log in to enjoy Wi-Fi.

By clicking the button below you agree to the [Terms and Conditions](#)

Log in with Facebook

Welcome Message

Privacy Policy & Terms and Conditions

Facebook Login

Welcome Message

Welcome!
Please log in to enjoy Wi-Fi.

(Max 1360 characters) Default

Privacy Policy & Terms and Conditions

Terms and Conditions Enable

User must tick to get the internet access

Description

By clicking the button below you agree to the Terms and Conditions.

Available settings are explained as follows:

Item	Description
------	-------------

Login dialog will be shown as follows:

Configure Login Method and Details

Welcome!
We are pleased to provide free
Wi-Fi to you!

By clicking the button below you agree to the [Terms and Conditions](#)

Accept

Welcome Message

Terms and Conditions Description and Content

Accept Button Description and Color

However, when **PIN with Voucher** is selected as the login method, Login dialog will be shown as follows:

Configure Login Method and Details

Welcome Message

Terms and Conditions Description and Content

Hint Message for PIN

Enter PIN and Submit Button

Welcome Message	Enter the text to be displayed as the welcome message.
Privacy Policy & Terms and Conditions	
Terms and Conditions	<p>Enable - Check the box to enable the option.</p> <p>User must tick to get the internet access - This check box is enabled in default if Terms and Conditions is enabled.</p> <p>Description - Enter the text to be displayed in the Terms and Conditions pop-up window.</p> <p>Content - It contains Internal Content and External Content. Choose Internal Content to enter the text to be displayed as the Terms and Conditions hyperlink text. Or choose External Content to enter an URL that will display the terms and conditions.</p>
Data Collection for Marketing	<p>Enable - Check the box to enable the option.</p> <p>User must tick to get the internet access - Check the box to enable the option.</p> <p>Description - Enter the text to inform the user.</p>
Error message when the user does not tick	Enter the text to notify the user.
Accept Button Description	Enter the text to be displayed on the accept button.
Accept Button Color	Select the color of the accept button from the predefined color list, or select Customize Color and enter the RGB value. Click Preview to preview the selected color.
Save and Next	Click to save the configuration on this page and proceed to the next page.
Cancel	Click to abort the configuration process and return to the profile summary page.
When PIN with Voucher is selected as the login method,	
Hint Message for PIN	Enter a message to remind the PIN code.
Enter PIN Description	Enter the existing PIN code.
Submit Button Description	Enter the text to be displayed on the Submit button.
Submit Button Color	Select the color of the Submit button from the predefined color list, or select Customize Color and enter the RGB value. Click Preview to preview the selected color.
Save and Next	Click to save the configuration on this page and proceed to the next page.

Cancel	Click to abort the configuration process and return to the profile summary page.
--------	--

Various Hotspot Login

This section describes the Login Page setup step if you have selected Various Hotspot Login the login method. You will see only settings that are relevant to the selected login method(s).

Hotspot Web Portal >> Profile Setup



Configure Login Method and Details

<p>Welcome! Please log in to enjoy Wi-Fi. By clicking the button below you agree to the Terms and Conditions</p> <p> Log in with Facebook</p> <p> Log in with Google</p> <p>Or log in with PIN code.</p> <p>Receive PIN via SMS</p> <p>Enter Existing PIN <input type="text"/> <input type="submit" value="Submit"/></p> <p>Or log in with your account.</p> <p>Username <input type="text"/></p> <p>Password <input type="password"/></p> <p><input type="submit" value="Login"/></p> <p>Welcome! Please leave info to enjoy Wi-Fi.</p> <p>Your Name <input type="text"/></p> <p>Your Email <input type="text"/></p> <p>Mobile Number <input type="text"/></p> <p><input type="submit" value="Submit"/></p>	<p>Welcome Message</p> <hr/> <p>Privacy Policy & Terms and Conditions</p> <hr/> <p>Facebook Login</p> <hr/> <p>Google Login</p> <hr/> <p>Hint Message for PIN</p> <hr/> <p>Receive PIN Description</p> <hr/> <p>Enter PIN and Submit Button</p> <hr/> <p>Hint Message for RADIUS</p> <hr/> <p>RADIUS Login</p> <hr/> <p>Hint Message for Leave info</p> <hr/> <p>Leave info Columns and Descriptions</p> <hr/> <p>Button</p>
--	--

Welcome Message

Welcome!
Please log in to enjoy Wi-Fi.

(Max 1360 characters)

Privacy Policy & Terms and Conditions

Terms and Conditions Enable

User must tick to get the internet access

Description

By clicking the button below you agree to the Terms and Conditions.

Settings that are common to Facebook, Google, PIN, and RADIUS authentication are:

Item	Description
Welcome Message	Enter the text to be displayed as the welcome message.

Privacy Policy & Terms and Conditions Description	Enter the text to be displayed as the Terms and Conditions hyperlink text.
Terms and Conditions Content	Enter the text to be displayed in the Terms and Conditions pop-up window.

If you have selected Facebook login, the setting will appear:

Facebook Login Description	<input type="text" value="Log in with Facebook"/>
	<p>(Max 170 characters) Default</p>

Item	Description
Facebook Login Description	Enter the text to be displayed on the Facebook login button.

If you have selected Google login, the setting will appear:

Google Login Description	<input type="text" value="Log in with Google"/>
	<p>(Max 170 characters) Default</p>

Item	Description
Google Login Description	Enter the text to be displayed on the Google login button.

If you have selected PIN login, these settings will appear:

Hint Message for PIN	<input type="text" value="Log in with PIN code."/> (Max 170 characters) <input type="button" value="Default"/>
Receiving PIN via SMS Description	<input type="text" value="Receive PIN via SMS"/> (Max 170 characters) <input type="button" value="Default"/>
Receiving PIN via SMS Content	<input type="text" value="Welcome to DrayTek Hotspot! Your PIN is <PIN>. This PIN is valid for 10 min."/> (Max 150 characters) <input type="button" value="Default"/>
Enter PIN Description	<input type="text" value="Enter Existing PIN"/> (Max 170 characters) <input type="button" value="Default"/>
Submit Button Description	<input type="text" value="Submit"/> (Max 170 characters) <input type="button" value="Default"/>
Submit Button Color	<input type="button" value="Customize Color"/> <input type="text" value="A2A2A2"/> (format : FFFFFFFF) <input type="button" value="Preview"/> <input type="button" value="Default"/>

Item	Description
Hint Message for PIN	Enter the text used to suggest users to choose SMS authentication.
Receiving PIN via SMS Description	Enter the text to be displayed on the button that the user clicks to receive an SMS PIN.
Receiving PIN via SMS Content	Enter the message to be sent by SMS to inform the user of the PIN. The PIN variable is specified by <PIN> within the message.
Receiving PIN via Mail Subject	Enter the subject of the mail to inform the user about the PIN code.
Receiving PIN via Mail Content	Enter the content of the mail to inform the user about the PIN code.
Enter PIN Description	Enter message to be displayed in the PIN textbox to prompt the user to enter the PIN.
Submit Button Description	Enter the text to be displayed on the submit PIN button
Submit Button Color	Select the color of the submit button from the predefined color list, or select Customize Color and enter the RGB value. Click Preview to preview the selected color.

If you have selected RADIUS account login, these settings will appear:

Hint Message for RADIUS	<input type="text" value="Log in with your account."/> (Max 170 characters) <input type="button" value="Default"/>
RADIUS Account Description	<input type="text" value="Username"/> (Max 170 characters) <input type="button" value="Default"/>
RADIUS Password Description	<input type="text" value="Password"/> (Max 170 characters) <input type="button" value="Default"/>
Login Button Description	<input type="text" value='Login'/> (Max 170 characters) <input type="button" value="Default"/>
Login Button Color	<input type="button" value="Customize Color"/> <input type="text" value="A2A2A2"/> (format : FFFFFFFF) <input type="button" value="Preview"/> <input type="button" value="Default"/>

Item	Description
Hint Message for RADIUS	Enter the text used to prompt the user to login.
RADIUS Account Description	Enter the text to prompt the user to enter the username.
RADIUS Password Description	Enter the text to prompt the user to enter the password.
Login Button Description	Enter the text to be displayed on the login button.
Login Button Color	Select the color of the login button from the predefined color list, or select Customize Color and enter the RGB value. Click Preview to preview the selected color.

And finally, the save and cancel buttons are always displayed.

Item	Description
Save and Next	Click to save the configuration on this page and proceed to the next page.
Cancel	Click to abort the configuration process and return to the profile summary page.

2nd-stage Page for PIN Login

If you have selected PIN Login as the login method, you will also need to configure the page that is displayed to users when they request a PIN.

Hotspot Web Portal >> Profile Setup



Configure 2nd-stage Page for SMS Login

< Back

PIN Code will be sent over via SMS.

+ 886

Send PIN

Back Button

PIN Code Message

Default Country, Enter Mobile Number Description

Send Button Description and Color

Send Succeeded Message

Enter PIN and Submit Button

Back Button Description

Back

(Max 170 characters) Default

PIN Code Message

PIN code will be sent over via SMS.

(Max 170 characters) Default

Default Country Code + 93 Afghanistan

Enter Mobile Number Description

enter your mobile number

(Max 170 characters) Default

Send Button Description

Send PIN

(Max 170 characters) Default

Send Button Color

Customize Color
(format : FFFFFFFF)
Preview
Default

Send Succeeded Message

PIN Code has been sent.Click Send PIN again if not receiving PIN in 3 minutes.

(Max 170 characters) Default

Save and Next
Cancel

Available settings are explained as follows:

Item	Description
Back Button Description	Enter text for the label of the hyperlink to return to the previous page.
PIN Code Message	Enter text to be displayed as the body text on the page.
Default Country	Select the default country code to be displayed using the dropdown

Code	menu.
Enter Mobile Number Description	Enter message to be displayed in the mobile number textbox to prompt the user to enter the mobile number.
Send Button Description	Enter the label text of the send button.
Send Button Color	Select the color of the send button from the predefined color list, or select Customize Color and enter the RGB value. Click Preview to preview the selected color.
Send Succeeded Message	Enter text to be displayed to notify the user after the PIN has been sent.
Save and Next	Click to save the configuration on this page and proceed to the next page.
Cancel	Click to abort the configuration process and return to the profile summary page.

4 Whitelist Setting

In this step you can configure the whitelist settings. Users are allowed to send and receive traffic that satisfies whitelist settings.

Hotspot Web Portal >> Profile Setup

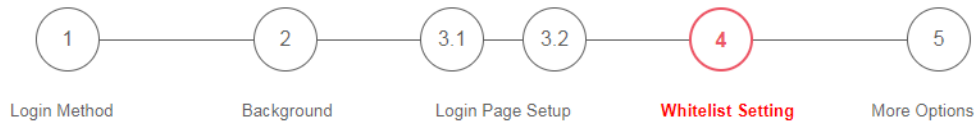

NAT Rules	Dest Domain	Dest IP	Dest Port	Source IP
Always allow outbound connections from hosts in		<input type="checkbox"/> NAT >> Port Redirection <input type="checkbox"/> NAT >> Open Ports <input type="checkbox"/> NAT >> DMZ		

Save and Next Cancel

Available settings are explained as follows:

Item	Description
NAT Rules	To prevent web portal settings from conflicting with NAT rules resulting in unexpected behavior, select the NAT rules that are allowed to bypass the web portal. Hosts listed in selected NAT rules can always access the Internet without being intercepted by the web portal.
Dest Domain	Enter up to 30 destination domains that are allowed to be accessed.
Dest IP	Enter up to 30 destination IP addresses that are allowed to be accessed.
Dest Port	Enter up to 30 destination protocols and ports that are allowed through the router.
Source IP	Enter up to 30 source IP addresses that are allowed through the router.
Save and Next	Click to save the configuration on this page and proceed to the next page.
Cancel	Click to abort the configuration process and return to the profile summary page.

5 More Options

In this step you can configure advanced options for the Hotspot Web Portal.

Hotspot Web Portal >> Profile Setup



Quota Management

Login Method	Quota Policy Profile	Valid Time	Device Allowed	Bandwidth Limit	Session Limit
SMS Login	1.Default	0d 5h 0m	Unlimited	Unlimited	Unlimited
Email Login	1.Default	0d 5h 0m	Unlimited	Unlimited	Unlimited

Note:

To modify the quota settings, please go to [Hotspot Web Portal >> Quota Management](#)

Web Portal Options

- HTTPS Redirection** Enable
 When an unauthenticated client opening a HTTPS page, redirect will work but certificate errors may be shown. Disable this function to redirect only HTTP pages. HTTPS browsing will timeout without redirection and also no certificate errors.
- Captive Portal Detection** Enable
 Trigger the unauthenticated client to automatically pop-up the Web Portal page when connects to Wi-Fi. This function is not available when using **Social Login** because the page may not be shown correctly due to the limitation of the OS built-in Captive Portal Detection.

Landing Page After Authentication

- Fixed URL
- User Requested URL

Available settings are explained as follows:

Item	Description
Quota Management	
Quota Policy Profile	Choose a policy profile to apply to web portal clients.
Web Portal Options	
HTTPS Redirection	If this option is selected, unauthenticated clients accessing HTTPS websites will be redirected to the login page, but the browser may alert the user of certificate errors. If this option is not selected, attempts to access to HTTPS website will time out without redirection.
Captive Portal Detection	If this option is selected, the web portal page is triggered automatically when an unauthenticated client tries to access the Internet. This function is not available when the Login Mode is Social Login , as the web portal page may not be shown correctly due to the limitations of the operating system's built-in Captive Portal Detection.
Bypass	If the number of HTTPS sessions exceeds the default limit, the web portal would temporarily bypass them without authentication.

	Those clients would be redirected to the web portal and authenticate later.
Landing Page After Authentication	
Fixed URL	Specifies the webpage that will be displayed after the user has successfully authenticated. The user will be redirected to the specified URL. This could be used for displaying advertisements to users, such as guests requesting wireless Internet access in a hotel.
User Requested URL	The user will be redirected to the URL they initially requested.
Bulletin Message	The message configured here will be briefly shown for a few seconds to the user. Default Message - This button is enabled when Bulletin Message is selected. Click to load the default text into the bulletin message textbox.
Force Landing Page Stay	This option is useful for mobile phone user. The mobile phone users can access into Internet by means of Wi-Fi connection. In general, when Captive Portal Detection is enabled on Vigor router, the login page will appear once the mobile phone detects the Wi-Fi signal. After entering the username and password (for authentication), the landing page will appear first on the screen of the mobile phone. Yet, some mobile phone will skip the landing page and access the Internet instead. This feature can force the landing page to stay on the screen of the mobile phone for a while. Enable - Select it to enter the period of time for keeping the landing page.
Applied Interfaces	
Subnet	The current Hotspot Web Portal profile will be in effect for the selected subnets.
Finish	Click to complete the configuration.
Cancel	Click to abort the configuration process and return to the profile summary page.

V-4-2 Users Information

The log information for users accessing into Internet through web portal will be shown on this page. Click a user link can open another web page displaying more detailed information.

V-4-2-1 User Info

The page can display user information based on the filtering conditions (profile or login method).

Hotspot Web Portal >> Users Information

User Info	Database Setup
<input type="checkbox"/> Select Columns to Filter Users	
<input type="checkbox"/> Profile1 <input type="checkbox"/> Profile2 <input type="checkbox"/> Profile3 <input type="checkbox"/> Profile4	<input type="checkbox"/> Skip <input type="checkbox"/> Click <input type="checkbox"/> Pincode <input type="checkbox"/> Facebook <input type="checkbox"/> Google <input type="checkbox"/> RADIUS
<input type="checkbox"/> Marketing	
<input type="button" value="OK"/>	

User Table

0 Online Users / 0 All Users

Auto Refresh (per min)

[Refresh Now](#)

Index	Status	Profile	User	Login Methods	IP	MAC	Email	Phone Number	Expired Time	
-------	--------	---------	------	---------------	----	-----	-------	--------------	--------------	--

Note:

Please set up [Database](#) to start showing user information.

Available settings are explained as follows:

Item	Description
Select Columns to Filter Users	Simply specify the profile and the login method for filtering users who want to access Internet through the login method. It is useful for system administrator to manage the user's access based on different conditions when there are a lot of users requiring to access into Internet.
User Table	Information for the users accessing into Internet via Hotspot Web Portal will be displayed and recorded in this page.

Click the MAC address link for certain user, information page related to the selected device will be shown as the following page.

88:d7:f6:57:6e:d1

Login Info

User Name	Login Methods	ID	Email	Phone
88:d7:f6:57:6e:d1	click-through	88:d7:f6:57:6e:d1	-	-

Devices

Log Out Device

Index	Status	IP	MAC	Online Time
<input type="checkbox"/> 1	Offline	192.16.2.138	88:d7:f6:57:6e:d1	

Login History (Latest 10 entries)

Index	Login	Logout	Duration	IP	MAC
1	2017-09-29 10:30:02	2017-09-29 10:30:53	00d 00h:00m	192.16.2.138	88:d7:f6:57:6e:d1

OK

Basic information for the device will be shown on the field of Login Info; online/offline status for the device can be send on the field of Devices; and historical information for device login will be shown on the field of Login History. In addition, to forcefully log out a selected device, simply check the one you want to logout and click the Log Out Device button.

V-4-2-2 Database Setup

This page allows the user to configure settings for database on USB disk.

Hotspot Web Portal >> Users Information

User Info	Database Setup
<input type="checkbox"/> Enable database <input type="checkbox"/> Enable sending user information to syslog File Path : No USB Disk Detected Database Usage : N/A <input type="button" value="Clear User Info"/>	

Notification and Action when Storage Exceeded

Notification

Don't send notification
 Send notification

Email Notification Object 1 - ??? ▾
SMS Notification Object 1 - ??? ▾

Action

Stop recording user information
 Backup and clean up all user info, and start a new record

Advanced options

Database Encryption

- Database encrypting is a irreversible process. Once enable Database Encryption, router will create a new encrypted database, which will not content the data from the non-encrypted database, and not able to change back to non-encrypted.
- Encryption mechanism may affect router performance when writing data.

Available settings are explained as follows:

Item	Description
Enable database	Check the box to record user information on router's database. Before checking this box, insert a USB disk with adequate storage space, first.
Enable sending user information to syslog	Check the box to send user information to syslog.
File Path	If a USB disk has been inserted into the USB port of Vigor router, the file path will be shown in this area.
Database Usage	Display the usage and remaining space on the database. Clear User Info - The user information will be displayed on the page of User Info. You can delete the information by clicking this button.
Notification and Action when Storage Exceeded	
Notification	Don't send notification - Vigor router system will not send any notification to any recipient. Send notification - Vigor router system will send a notification e-mail to specified recipient(s) that selected from Email Notification Object and SMS Notification Object .
Action	Stop recording user information - Vigor router system will stop to record the user information onto USB disk.

	Backup and clean up all user info, and start a new record - Vigor router system will backup all existed information on the USB disk onto the host and clean up the information from USB disk. Later, it will start a new record.
Advanced options	
Database Encryption	Select to have the router create a new encrypted database. Once this is done, you will not be able to revert to an unencrypted database.

V-4-3 Quota Management

The system administrator can specify bandwidth and sessions quota which is only applicable to the web portal clients.

Settings configured in Quota Management will override the policies set in **Bandwidth Management>>Bandwidth Limit** and **Bandwidth Management>>Limit**.

Hotspot Web Portal >> Quota Management

Web Portal Bandwidth and Session Limit

The settings here will apply only to the web portal clients and will override the policies set in Bandwidth Management.

Bandwidth Limit

Session Limit

Quota Policy Profile

Index	Name	Expired Time after First Login	Device Allowed per Account	Reconnection Time Restriction	Bandwidth Limit	Session Limit
1	Default	0d 5h 0m	Unlimited	Unlimited	Unlimited	Unlimited
<input type="button" value="Add"/> (up to 20)						

Available settings are explained as follows:

Item	Description
Bandwidth Limit	Check the box to override the policy configured in Bandwidth Management>>Bandwidth Limit .
Session Limit	Check the box to override the policy configured in Bandwidth Management>>Session Limit .
Quota Policy Profile	Add - Create up to 20 policy profiles in such page.

To create a new quota policy profile, click **Add** to open the following page.

Hotspot Web Portal >> Management >> Quota Policy Profile 2

Profile Name

Account Validity

Expired Time After the First Login days hours min
 Idle Timeout min

Device Control

Devices Allowed per account

Reconnection Time Restriction At : everyday
Block the same user from reconnecting before the set time
 hours min
Block the same user from reconnecting for the set period

Bandwidth and Session Limit

Bandwidth Limit

Download Limit Kbps Mbps

Upload Limit Kbps Mbps

Session Limit sessions

Available settings are explained as follows:

Item	Description
Profile Name	Enter a name for a new profile.
Account Validity	Set the duration for which the login is valid. Expired Time After the First Login - Sets the days, hours, and minutes. After the login has expired, Vigor router will block the client from accessing the network/Internet. Idle Timeout - When this option is selected, Vigor router will terminate the network connection if there is no activity from the user after the specified idle time has passed.
Device Control	Set the maximum number of devices that can be connected for each account, and the time restriction for the client accessing Internet via the web portal. Devices Allowed per account - Use the drop-down list to select the maximum number of devices that can be connected to the network using the same account. Reconnection Time Restriction - Blocks the account from being used to connect devices to the network in one of two ways: <ul style="list-style-type: none"> ● At ... Everyday - After the login expires, the account cannot be used to connect devices to the network until the set time of day. ● Hours.. min - After the login expires, the account cannot be used to connect devices to the network for a set period of time.
Bandwidth and	Bandwidth Limit - Check the box to configure bandwidth limit for

Session Limit	web portal client. <ul style="list-style-type: none">● Download/Upload Limits - Set the maximum upload and download speeds. Session Limit - Check the box to configure a maximum session limit for web portal clients.
----------------------	--

After finishing all the settings here, please click **OK** to save the configuration.

V-4-4 PIN Generator

The system administrator can generate multiple PIN codes for various usage. Before generating PIN codes, please make sure a USB has been inserted onto your Vigor device.

V-4-4-1 PIN Status

This page displays the PIN codes generated by PIN Generator.

Hotspot Web Portal >> PIN Generator

PIN Status		PIN Generator		PIN Voucher			
Filter							
Profile	Batch Name	Status	Quota Policy	PIN	Expiry Time		
ALL	ALL	<input checked="" type="checkbox"/> Unused <input checked="" type="checkbox"/> Used	ALL		<input checked="" type="checkbox"/> Expired <input checked="" type="checkbox"/> Unexpired		
OK							
Showing 1-50 of 500				Export to CSV File Delete All			
PIN	Profile	Status	Batch Name	Valid Through	Quota Policy	Activated On	Expiry Time
004840	1	Unused	Hotel_1	2000-01-09 00:52:07	1-Default		X
006240	1	Unused	Hotel_1	2000-01-09 00:52:07	1-Default		X
006608	1	Unused	Hotel_1	2000-01-09 00:52:07	1-Default		X
010523	1	Unused	Hotel_1	2000-01-09 00:52:07	1-Default		X
011391	1	Unused	Hotel_1	2000-01-09 00:52:07	1-Default		X
014507	1	Unused	Hotel_1	2000-01-09 00:52:07	1-Default		X
015771	1	Unused	Hotel_1	2000-01-09 00:52:07	1-Default		X
017016	1	Unused	Hotel_1	2000-01-09 00:52:07	1-Default		X
018167	1	Unused	Hotel_1	2000-01-09 00:52:07	1-Default		X
024084	1	Unused	Hotel_1	2000-01-09 00:52:07	1-Default		X
028484	1	Unused	Hotel_1	2000-01-09 00:52:07	1-Default		X

Available settings are explained as follows:

Item	Description
Profile	Use the drop down menu to choose an index number (1 to 4) for PIN generator profile.
Batch Name	Use the drop down menu to choose an existed PIN profile or choose ALL to display the PIN status.
Status	Unused - After checking the box, only the unused PIN codes will be shown on this page. Used - After checking the box, only the used PIN codes will be shown on this page.
Quota Policy	Use the drop down menu to choose a quota management policy to display related PIN codes.
PIN	Enter the PIN code to display related information on this page.
Expiry Time	Expired - After checking the box, only the expired PIN codes will be shown on this page. Unexpired - After checking the box, only the unexpired PIN codes will be shown on this page.
OK	Click it to display the PIN code according to the above filtering condition.
Export to CSV File	Click it to export the configuration of PIN code as a CSV file.

V-4-4-2 PIN Generator

The system administrator can generate multiple PIN codes in response to the user's (e.g., enterprise) demand.

Hotspot Web Portal >> PIN Generator

PIN Status	PIN Generator	PIN Voucher														
Profile	1 ▾															
Batch Name	First_batch															
PIN code length	6 ▾ digits															
PIN Validity	1 ▾ days 0 ▾ hours															
	The period of time the PIN will be kept in the database.															
Quantity	100															
Quota Management Policy	1-Default ▾															
	<table border="1"> <thead> <tr> <th>Index</th> <th>Name</th> <th>Expired Time after Activation</th> <th>Device Allowed per Account</th> <th>Reconnection Time Restriction</th> <th>Download Bandwidth Limit</th> <th>Session Limit</th> </tr> </thead> <tbody> <tr> <td>1</td> <td>Default</td> <td>0d 5h 0m</td> <td>Unlimited</td> <td>Unlimited</td> <td>Unlimited</td> <td>Unlimited</td> </tr> </tbody> </table>		Index	Name	Expired Time after Activation	Device Allowed per Account	Reconnection Time Restriction	Download Bandwidth Limit	Session Limit	1	Default	0d 5h 0m	Unlimited	Unlimited	Unlimited	Unlimited
Index	Name	Expired Time after Activation	Device Allowed per Account	Reconnection Time Restriction	Download Bandwidth Limit	Session Limit										
1	Default	0d 5h 0m	Unlimited	Unlimited	Unlimited	Unlimited										
	Generate															

Note:

Please set up [Database](#) to start generating PIN codes.

Available settings are explained as follows:

Item	Description
Profile	Use the drop down menu to specify an index number (from 1 to 4).
Batch Name	Enter a string as a batch name.
PIN code length	Specify the length of PIN code.
PIN Validity	Set the period of time.
Quantity	Set the quantity of the PIN code.
Quota Management Policy	Use the drop down list to choose policy profile. Click the index number link to edit the selected policy profile.
Generate	Click it to generate a PIN code as a voucher. The system will ask you to set up Database before executing the generation.

Quota Management Policy 1-Default ▾

Index	Name	Expired Time after Activation	Device Allowed per Account	Reconnection Time Restriction	Download Bandwidth Limit	Session Limit
1	Default	0d 5h 0m	Unlimited	Unlimited	Unlimited	Unlimited

Generate

Note:
Later, available PIN code will be shown on PIN Status.

Hotspot Web Portal >> PIN Generator

PIN Status		PIN Generator		PIN Voucher			
Filter							
Profile	Batch Name	Status	Quota Policy	PIN	Expiry Time		
ALL	ALL	<input checked="" type="checkbox"/> Unused <input checked="" type="checkbox"/> Used	ALL	<input type="text"/>	<input checked="" type="checkbox"/> Expired <input checked="" type="checkbox"/> Unexpired		
OK							
Showing 1-50 of 500		Export to CSV File Delete All					
PIN	Profile	Status	Batch Name	Valid Through	Quota Policy	Activated On	Expiry Time
004840	1	Unused	Hotel_1	2000-01-09 00:52:07	1-Default		X
006240	1	Unused	Hotel_1	2000-01-09 00:52:07	1-Default		X
006608	1	Unused	Hotel_1	2000-01-09 00:52:07	1-Default		X
010523	1	Unused	Hotel_1	2000-01-09 00:52:07	1-Default		X
011391	1	Unused	Hotel_1	2000-01-09 00:52:07	1-Default		X
014507	1	Unused	Hotel_1	2000-01-09 00:52:07	1-Default		X
015771	1	Unused	Hotel_1	2000-01-09 00:52:07	1-Default		X
017016	1	Unused	Hotel_1	2000-01-09 00:52:07	1-Default		X
018167	1	Unused	Hotel_1	2000-01-09 00:52:07	1-Default		X
024084	1	Unused	Hotel_1	2000-01-09 00:52:07	1-Default		X
028484	1	Unused	Hotel_1	2000-01-09 00:52:07	1-Default		X
032141	1	Unused	Hotel_1	2000-01-09 00:52:07	1-Default		X
034187	1	Unused	Hotel_1	2000-01-09 00:52:07	1-Default		X
035052	1	Unused	Hotel_1	2000-01-09 00:52:07	1-Default		X
036565	1	Unused	Hotel_1	2000-01-09 00:52:07	1-Default		X
038569	1	Unused	Hotel_1	2000-01-09 00:52:07	1-Default		X
040262	1	Unused	Hotel_1	2000-01-09 00:52:07	1-Default		X
042268	1	Unused	Hotel_1	2000-01-09 00:52:07	1-Default		X
048446	1	Unused	Hotel_1	2000-01-09 00:52:07	1-Default		X
048842	1	Unused	Hotel_1	2000-01-09 00:52:07	1-Default		X
050503	1	Unused	Hotel_1	2000-01-09 00:52:07	1-Default		X
053852	1	Unused	Hotel_1	2000-01-09 00:52:07	1-Default		X
053935	1	Unused	Hotel_1	2000-01-09 00:52:07	1-Default		X
054543	1	Unused	Hotel_1	2000-01-09 00:52:07	1-Default		X
059971	1	Unused	Hotel_1	2000-01-09 00:52:07	1-Default		X
064680	1	Unused	Hotel_1	2000-01-09 00:52:07	1-Default		X

V-4-4-3 PIN Voucher

This page allows to print out the PIN code list.

Hotspot Web Portal >> PIN Generator

PIN Status		PIN Generator		PIN Voucher	
Profile	<input type="text" value="1"/>	Batch	<input type="text"/>	<input checked="" type="checkbox"/> Voucher Title	<input type="text"/>
			(Unused Only)	<input checked="" type="checkbox"/> Show Quota Policy	<input checked="" type="checkbox"/> Expired Time after first login
				<input checked="" type="checkbox"/> Message	<input checked="" type="checkbox"/> Device Allowed
				<input checked="" type="checkbox"/> Show Valid Date	<input checked="" type="checkbox"/> Bandwidth Limit
				<input checked="" type="checkbox"/> Use Default Setting	<input checked="" type="checkbox"/> Session Limit
Column	<input type="text" value="3"/>	Height	<input type="text"/>	<input type="text"/>	
		Width	<input type="text"/>		
Preview and Print					

Available settings are explained as follows:

Item	Description
Profile	Use the drop down menu to specify an index number (from 1 to 4).
Batch	Use the drop down menu to specify an unused batch profile.
Voucher Title	Enter a string as a title which will be shown on a print out paper.

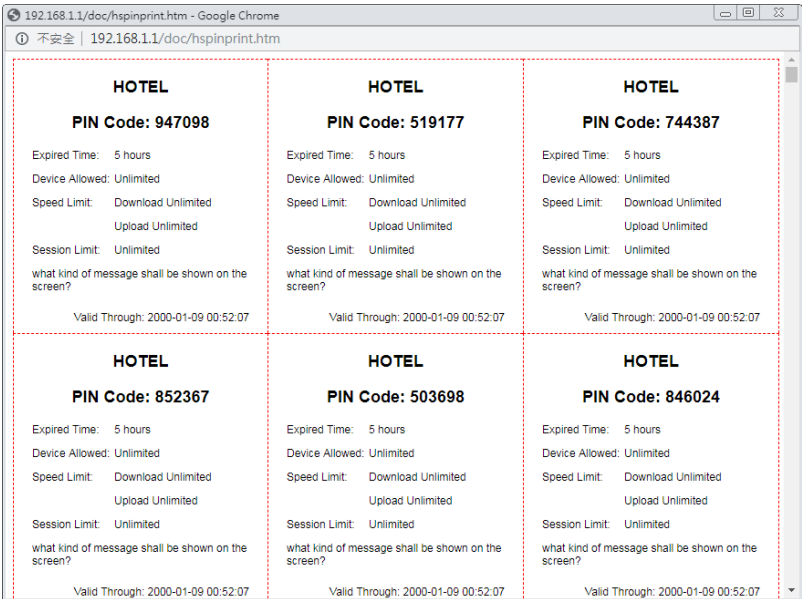
Show Quota Policy	Select the item(s) to be shown on the print-out PIN code list.
Message	Enter a brief description that the client should know.
Show Valid Date	Check the box to display the valid date and time on the printed out list.
Use Default Setting	<p>Set the paper size for printing the vouchers on label printer.</p> <p>Column - Use the drop-down list to specify the column value.</p> <p>Height - Enter the value of the height.</p> <p>Width - Enter the value of the width.</p> <p>Or select to use the default settings.</p>
Preview and Print	<p>Click it to display the PIN code list. This list can be printed out if required.</p> 

Application Notes

A-1 How to allow users login to Vigor's Hotspot with their social media accounts (e.g., Facebook & Google)

Vigor Router supports Hotspot Web Portal function. The network administrator can set Vigor Router as a Hotspot provider with web authentication and allow users to log in with their social media accounts, such as Facebook and Google. We demonstrate how to set up the hotspot web portal with Facebook login in the following paragraphs.

Vigor Router Setup

1. Make sure the router is connected to the Internet.

Online Status

Physical Connection System Uptime: 0day 0:11:28

IPv4		IPv6			
LAN Status		Primary DNS: 168.95.1.1		Secondary DNS: 168.95.192.1	
IP Address	TX Packets	RX Packets			
192.168.60.1	5,950	6,130			
WAN 1 Status >> Drop PPPoE					
Enable	Line	Name	Mode	Up Time	
Yes	Ethernet		PPPoE	0:11:23	
IP	GW IP	TX Packets	TX Rate(Bps)	RX Packets	RX Rate(Bps)
192.168.60.1	168.95.1.1	5,041	215	5,689	393

2. Go to Hotspot Web Portal >> Profile Setup, click on an available index.

Hotspot Web Portal >> Profile Setup ?

Hotspot Web Portal Profile:

Index	Enable	Comments	Login Mode	Applied Interface	
1.	<input type="checkbox"/>		Click-through	None	Preview
2.	<input type="checkbox"/>		Click-through	None	Preview
3.	<input type="checkbox"/>		Click-through	None	Preview
4.	<input type="checkbox"/>		Click-through	None	Preview

Note:

1. The router must connect to the Internet before webpage redirection will work.
2. If the LAN clients are using another DNS server on LAN, please make sure the DNS query for domain name "portal.draytek.com" will be resolved by the router.

OK

3. Enter the values as the following figure.

Enable this profile **a**

Comments: **b**

Portal Server

Portal Method Skip Login, landing page only
 Click through
 Various Hotspot Login **c**

Captive Portal URL **d**

Login Methods

Choose Login Method Login with Facebook **d**
 Login with Google
 Receive PIN via SMS

Facebook

Facebook APP ID **e**

Facebook APP Secret

Google

Google App ID

Google App Secret

f

- (a) Click **Enable this profile**.
- (b) Enter the comments.
- (c) Select **Various Hotspot Login** for Portal Method.
- (d) Choose **Login with Facebook** or **Login with Google** as Login Method.

If **Login with Facebook** is selected, the protocol of the **Captive Portal URL** need to be changed to **HTTPS** instead of **HTTP** because Facebook force to use **HTTPS** URL in their policy.

- (e) Enter the **APP ID** and secret.
- (f) Click **Save and Next**.

- Choose the **Color Background**, customize the information a logo color, and click **Save and Next**.

Hotspot Web Portal >> ProfileSetup

1 — 2 — 3 — 4 — 5

Login Method
Background
Login Page Setup
Whitelist Setting
More Options

Choose Login Background

Color Background



1. Browser Tab Title
2. Logo Image & Logo Background Color
3. Login Methods Background Color

Image Background

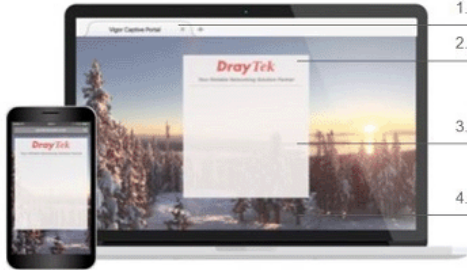

1. Browser Tab Title
2. Logo Image
3. Login Methods Background Color and Opacity
4. Background Image

Login Page URL

Browser Table Title

Logo Image

DrayTek

Logo Background Color

(format : FFFFFFFF)

Login Method Background Color

(format : FFFFFFFF)

You can click the Step Icon on the top of the page to go to the step you want. The router will save your setting automatically.

Or choose the **Image Background**, customize the information and background image, and click **Save and Next**.

Hotspot Web Portal >> Profile Setup

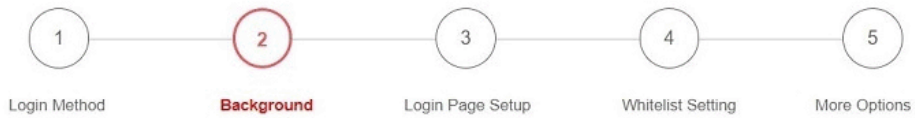

Choose Login Background

Color Background



Image Background



Login Page URL:

Browser Table Title:

Logo Image:



Login Method Background Color:

(format : FFFFFFFF)

Opacity(10 ~ 100): %

Background Image: No file chosen (max size: 1MB)

5. Customize the descriptions on the login page, then click **Save and Next**.

Configure Login Method and Details

Welcome!
Please log in to enjoy Wi-Fi.

By clicking the button below you agree to the [Terms and Conditions](#)

Welcome Message _____

Terms and Conditions Description and Content _____

Facebook Login _____

Google Login _____

Welcome Message

Welcome to Draytek Video!
Please log in to enjoy Wi-Fi.

(Max 1360 characters)

Default

Terms and Conditions Description

By clicking the button below you agree to the Terms and Conditions.

(Max 170 characters)

Default

Terms and Conditions Content

(Max 1360 characters)

Facebook Login Description

Log in with Facebook

(Max 170 characters)

Default

Google Login Description

Log in with Google

(Max 170 characters)

Default

Save and Next
Cancel

6. You can set the **Whitelist** for the profile here to allow specific clients to access the internet or certain websites can be visited without login.

Hotspot Web Portal >> Profile Setup

1
2
3
4
5

Login Method

Background

Login Page Setup

Whitelist Setting

More Options

NAT Rules	Dest Domain	Dest IP	Dest Port	Source IP
Always allow outbound connections from hosts in		<input type="checkbox"/> NAT >> Port Redirection <input type="checkbox"/> NAT >> Open Ports <input type="checkbox"/> NAT >> DMZ		

Save and Next
Cancel

- Set up the **Expired Time After Activation** and **Landing Page After Activation** that Hotspot clients will see after they login successfully. Finally, select the interfaces to which you would like this hotspot profile apply to, then click **Finish** to save the setting.

Hotspot Web Portal >> Profile Setup

1
Login Method

2
Background

3
Login Page Setup

4
Whitelist Setting

5
More Options

Web Portal Options

Expired Time After Activation 0 days 5 hours 0 min

HTTPS Redirection Enable
When an unauthenticated client opening a HTTPS page, redirect will work but certificate errors may be shown. Disable this function to redirect only HTTP pages. HTTPS browsing will timeout without redirection and also no certificate errors.

Captive Portal Detection Enable
Trigger the unauthenticated client to automatically pop-up the Web Portal page when connects to Wi-Fi. This function is not available when using **Social Login** because the page may not be shown correctly due to the limitation of the OS built-in Captive Portal Detection.

Landing Page After Authentication

Fixed URL
 User Requested URL
 Bulletin Message

(Max 511 characters) Default Message

Note:
Landing Page may not be shown correctly when using OS built-in Captive Portal Detection.

Applied Interfaces

Subnet		<input checked="" type="checkbox"/> LAN1 <input type="checkbox"/> LAN2 <input type="checkbox"/> LAN3 <input type="checkbox"/> LAN4 <input type="checkbox"/> LAN5
WLAN	2.4G	<input type="checkbox"/> SSID1 (FAE_Victor_2925_VLC_test) <input type="checkbox"/> SSID2 (DrayTek_Guest) <input type="checkbox"/> SSID3 <input type="checkbox"/> SSID4
	5G	<input type="checkbox"/> SSID1 (DrayTek_5G) <input type="checkbox"/> SSID2 (DrayTek_5G_Guest) <input type="checkbox"/> SSID3 <input type="checkbox"/> SSID4

- Then the Hotspot setup is finished. You may click Preview to check the login page.

Hotspot Web Portal >> Profile Setup ?

Hotspot Web Portal Profile:

Index	Enable	Comments	Login Mode	Applied Interface	
1.	<input checked="" type="checkbox"/>	DrayTek	Social Login	LAN(1)	<input type="button" value="Preview"/>
2.	<input type="checkbox"/>		Click-through	None	<input type="button" value="Preview"/>
3.	<input type="checkbox"/>		Click-through	None	<input type="button" value="Preview"/>
4.	<input type="checkbox"/>		Click-through	None	<input type="button" value="Preview"/>

Note:
 1. The router must connect to the Internet before webpage redirection will work.
 2. If the LAN clients are using another DNS server on LAN, please make sure the DNS query for domain name "portal.draytek.com" will be resolved by the router.

Hotspot Clients Login

- Now, when clients connect to the selected router interface, and try to access internet, they will be redirected to "portal.draytek.com".

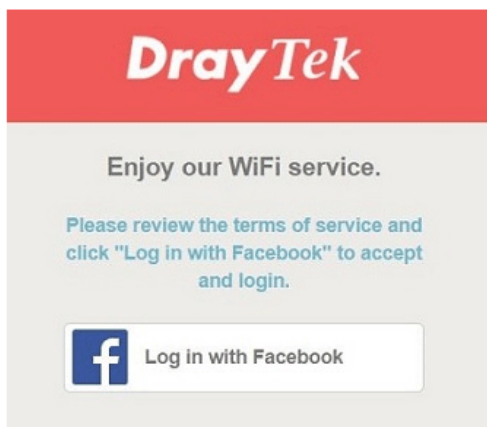

- Due to security concerns, the browser might warn that it cannot verify server identity, the clients would need to tap "Continue" before they can proceed to portal.draytek.com.
 - The client might not be able to access "portal.draytek.com" if this domain name is resolved by a DNS server on LAN. If so, set up LAN DNS to make sure the domain name will be resolved to the router's LAN IP.
- Tap on a login method, and it will open the social media login page. Enter the social media accounts and password to log in.

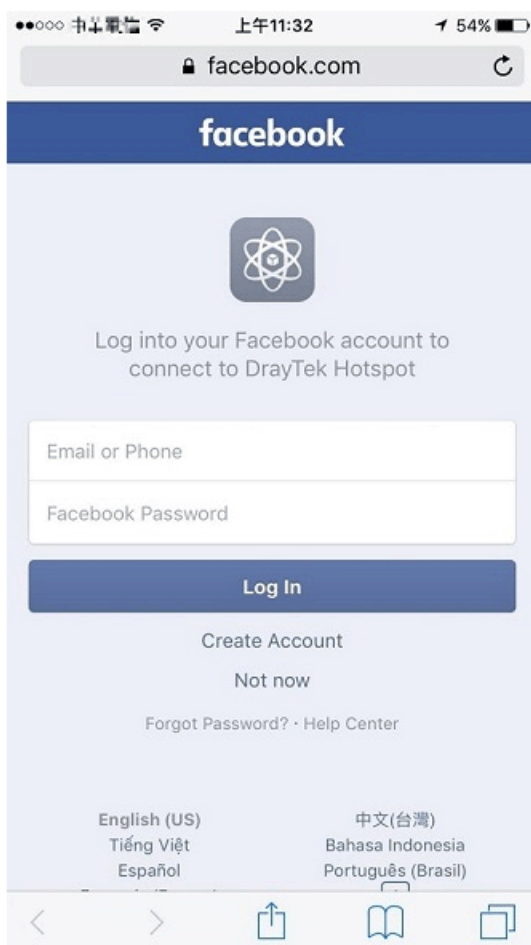

- If the credentials are correct, the client will be redirected to the landing page and be able to access the Internet afterward.



User Information

Network administrator can plug the USB disk to router, to record the basic information of the users who connect to the Wi-Fi and login with their social media accounts. The users' basic information will be listed on Hotspot Web Portal >> Users Information page.

Hotspot Web Portal >> Users Information

User Info Database Setup

Select Columns to Filter Users

Profile	Login Method
<input type="checkbox"/> Profile 1	<input type="checkbox"/> Facebook
<input type="checkbox"/> Profile 2	<input type="checkbox"/> Google
<input type="checkbox"/> Profile 3	<input type="checkbox"/> Pincode
<input type="checkbox"/> Profile 4	<input type="checkbox"/> Click

OK

User Table

Auto Refresh (per min) | Refresh Now

2 Online Users / 2 All Users User Search

Index	Status	Profile	User	Login Methods	IP	MAC	Email	Phone Number	Expired Time	
1	Online	1	Anderson	facebook	192.168.162.10	80:7a:bf:d1:bd:c1	wy@111@gmail.com	-	2017-10-25 11:04:54	
2	Online	1	Zhuang	facebook	192.168.162.11	6c:8d:c1:11:b:c4	wy@111@gmail.com	-	2017-10-25 11:08:57	

A-2 How to allow hotspot clients to get login PIN code via SMS?

Since 3.8.4.3 version firmware, Vigor Router can act as a hotspot gateway and provide internet access only to the authenticated clients. Network Administrator may set up the router to allow hotspot client to get the login PIN code from an SMS message. This note is going to demonstrate how to set up Vigor Router as a hotspot gateway and be able to send the PIN code to clients by SMS messages.

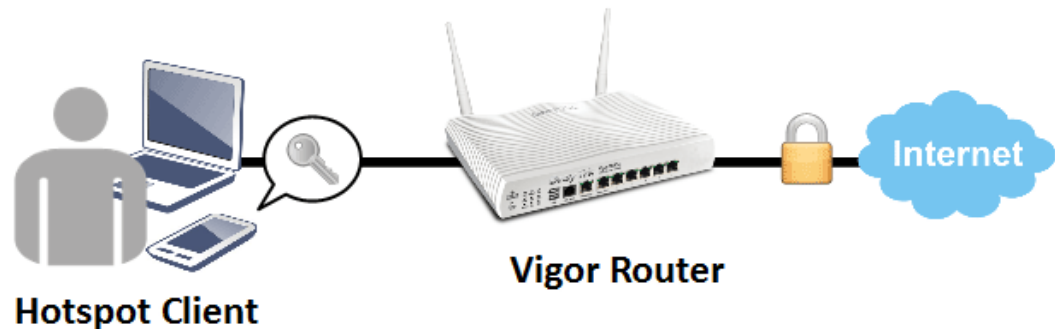

Vigor Router Setup

1. Make sure the router is connected to the Internet.

Online Status

Physical Connection			System Uptime: 0day 0:11:28		
IPv4		IPv6			
LAN Status	Primary DNS: 168.95.1.1		Secondary DNS: 168.95.192.1		
IP Address	TX Packets	RX Packets			
192.168.60.1	5,950	6,130			
WAN 1 Status					>> Drop PPPoE
Enable	Line	Name	Mode	Up Time	
Yes	Ethernet		PPPoE	0:11:23	
IP	GW IP	TX Packets	TX Rate(Bps)	RX Packets	RX Rate(Bps)
168.95.192.1	168.95.1.1	5,041	215	5,689	393

2. Create an SMS Object to send SMS messages. Go to Objects Setting >> SMS Service Object, and click on an available profile.

Objects Setting >> SMS / Mail Service Object

SMS Provider	Mail Server	
Set to Factory Default		
Index	Profile Name	SMS Provider
1.		kotsms.com.tw (TW)
2.		kotsms.com.tw (TW)
3.		kotsms.com.tw (TW)
4.		kotsms.com.tw (TW)
5.		kotsms.com.tw (TW)
6.		kotsms.com.tw (TW)
7.		kotsms.com.tw (TW)
8.		kotsms.com.tw (TW)
9.	Custom 1	
10.	Custom 2	

- Enter the Service Provider details, and click OK to apply.

Objects Setting >> SMS / Mail Service Object

Profile Index: 1

Profile Name	hotspot
Service Provider	kotsms.com.tw (TW) ▼
Username	m
Password	*****
Quota	10
Sending Interval	3 (seconds)

- Go to Hotspot Web Portal >> Profile Setup, click on an available profile.

Hotspot Web Portal >> Profile Setup



Hotspot Web Portal Profile:

Index	Enable	Comments	Login Mode	Applied Interface	
1.	<input type="checkbox"/>		Skip Login	None	Preview
2.	<input type="checkbox"/>		Skip Login	None	Preview
3.	<input type="checkbox"/>		Skip Login	None	Preview
4.	<input type="checkbox"/>		Skip Login	None	Preview

- Enable the profile, give a comment, and choose "PIN Code Login". Then click Next.

Hotspot Web Portal >> Hotspot Web Portal Setup

Profile 1

Enable

Comments: SMS authenticate

Choose How Users Receive Internet Access

Skip Login

skip login phase and redirect to landing page immediately

Click-through

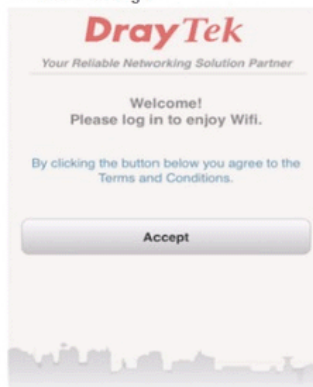

A space for you to display the terms and conditions. Users have to click Accept button (wording configurable) to get WiFi access.

Social Login

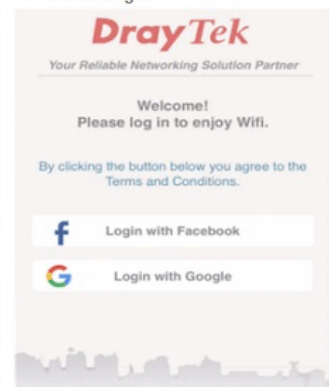

Login with Facebook or Google account.

PIN Code Login

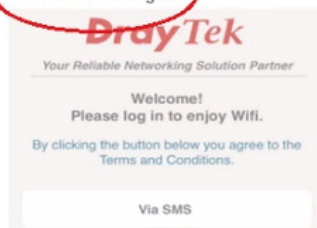

Social or PIN Login

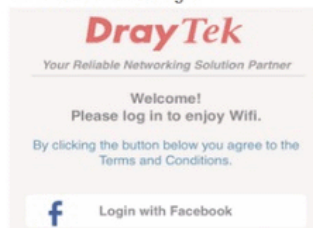

- Choose a login page design, customize the details, and click **Next**.

Hotspot Web Portal >> Hotspot Web Portal Setup

Profile 1

Design Login Page Appearance

Color Background

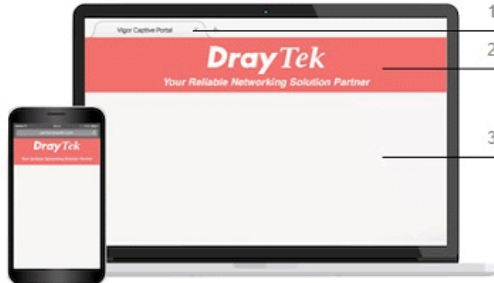

1. Browser Tab Title
2. Logo Image & Logo Background Color
3. Login Methods Background Color

Image Background

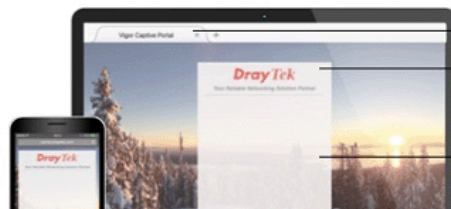

1. Browser Tab Title
2. Logo Image
3. Login Methods Background Color and Opacity

- Edit the message on the login page, and click **Next**.

Receiving PIN via SMS Description	<input type="text" value="Get password via SMS"/> (Max 170 characters) Default
Receiving PIN via SMS Content	<input type="text" value="Welcome to DrayTek Hotspot!Your password is <PIN>.This PIN will be valid for 10 min."/> (Max 150 characters) Default
Receiving PIN via SMS Provider	<input type="text" value="1 - hotspot"/> Set SMS Provider in Objects Setting >> SMS / Mail Service Object
Enter PIN Description	<input type="text" value="Enter password"/> (Max 170 characters) Default
Submit Button Description	<input type="text" value="Login"/> (Max 170 characters) Default
Submit Button Color	<input type="text" value="A2A2A2"/> (format : FFFFFFFF) Default

- Edit the details for SMS settings, then click **Next**.

Back Button Description

(Max 170 characters) Default

PIN Code Message

Password will be sent over via SMS.

(Max 170 characters) Default

Default Country Code

+ 886 Taiwan

Enter Mobile Number Description

enter your mobile number

(Max 170 characters) Default

Send Button Description

Get password

(Max 170 characters) Default

Send Button Color

A2A2A2 (format : FFFFFFFF) Default

Send Succeeded Message

Password has been sent. Click Get password again if not receiving password in 3 minutes.

(Max 170 characters) Default

9. Edit the landing page, choose the interfaces to which the SMS login should apply, and then click **Finish**.

Hotspot Web Portal >> Hotspot Web Portal Setup

Profile 1

Configure Landing Page After Login

- Fixed URL
- User Requested URL
- Bulletin Message

(Max 4095 characters) Default Message

Configure Applied Interfaces

- Subnet LAN1 LAN2 LAN3 LAN4 LAN5 LAN6
- WLAN 2.4G SSID1 (DrayTek)
- SSID2 (DrayTek_Guest)
- SSID3
- SSID4

Back Cancel Finish

10. Now, the hotspot settings are applied to the selected interfaces. You may click **Preview** to check how the login page looks.



Hotspot Web Portal Profile:

Index	Enable	Comments	Login Mode	Applied Interface	
1.	<input checked="" type="checkbox"/>	SMS authenticate	PIN Code Login	WLAN2.4G(2)	Preview
2.	<input type="checkbox"/>		Skin Login	None	Preview
3.	<input type="checkbox"/>				Preview
4.	<input type="checkbox"/>				Preview

Note:
The router mu

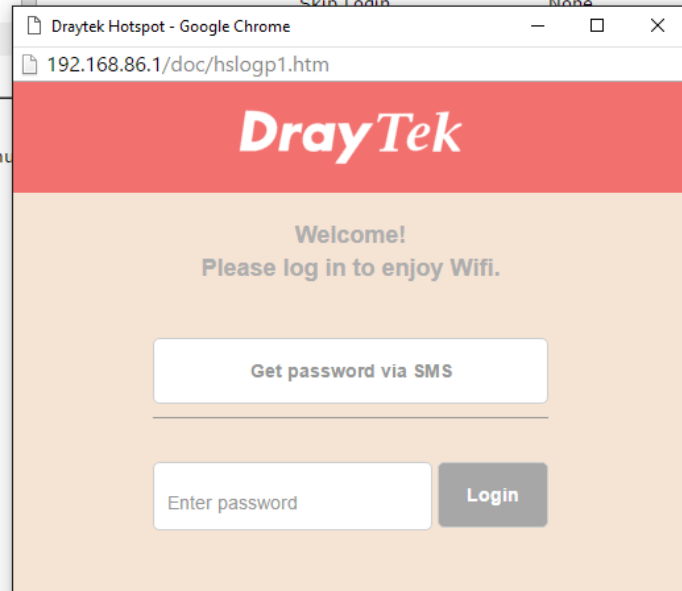

Hotspot Client Login

11. If the client connected to the selected interface of the router and try to open a webpage, they will be redirected to hotspot login page. If they do not have a password yet, they can click on the button to get a password.

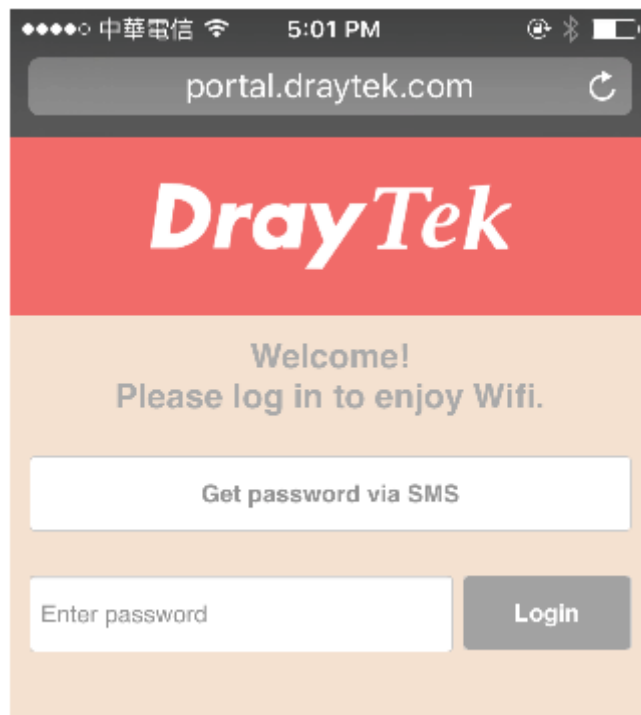



Info

- Due to security concerns, the browser might warn that it cannot verify server identity, the clients would need to tap "continue" before they can proceed to portal.draytek.com.
- The client might not be able to access "portal.draytek.com" if this domain name is resolved by a DNS server on LAN. If so, set up LAN DNS to make sure the domain name will be resolved to the router's LAN IP.

12. Enter the mobile phone number to receive the SMS message.

The screenshot shows a mobile browser interface for the DrayTek portal. At the top, the status bar displays '中華電信' (Chunghwa Telecom), signal strength, Wi-Fi, and the time '5:02 PM'. The address bar shows 'portal.draytek.com'. Below the address bar is a red header with the 'DrayTek' logo. The main content area has a light beige background and contains the following elements: a back arrow icon, the text 'Password will be sent over via SMS.', a phone number input field with a dropdown menu showing '+ 886' and a text input containing '918', a grey 'Get password' button, a horizontal separator line, a password input field with the placeholder text 'Enter password', and a grey 'Login' button.

13. The number will get a message about the password.

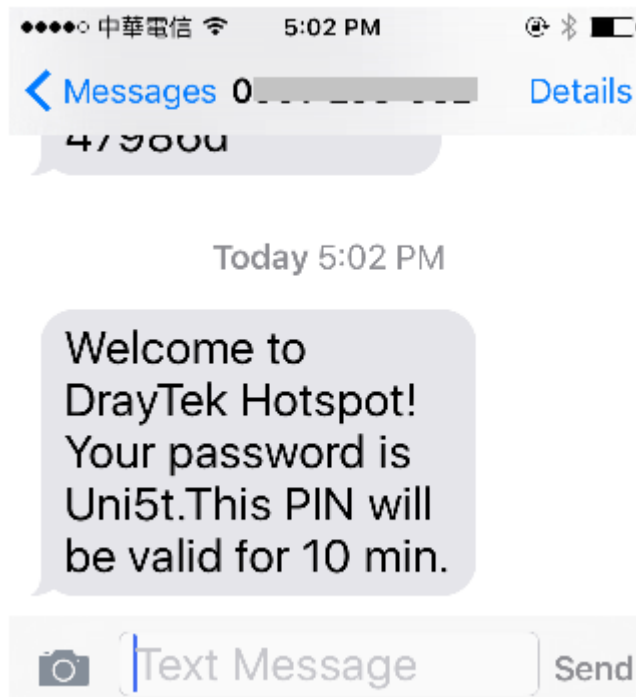

14. Enter the password on the login page, and click Login.

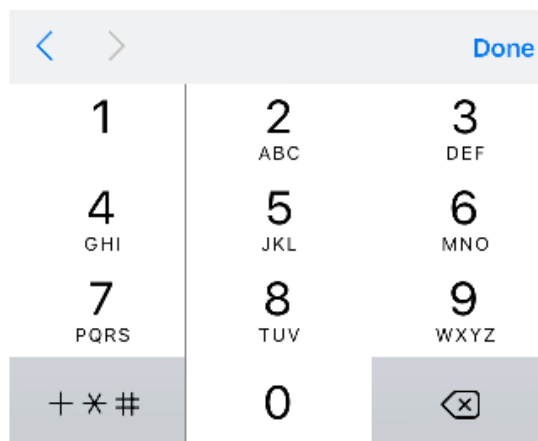
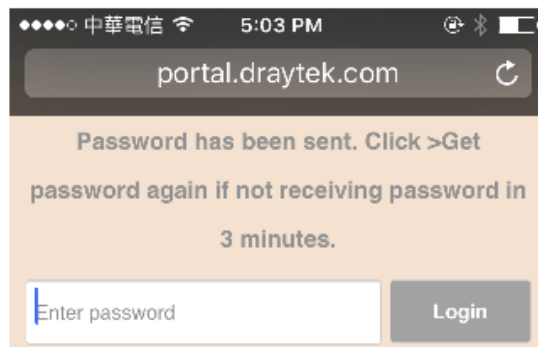

15. If the password is correct, the client will be redirected to the landing page, and after that, they will be able to surf the Internet.



V-5 Central Management (AP)

Vigor3912 can manage the access points supporting AP management via Central AP Management.

AP Maintenance

Vigor router can execute configuration backup, configuration restoration, firmware upgrade and remote reboot for the APs managed by the router. It is very convenient for the administrator to process maintenance without accessing into the web user interface of the access point.

Load Balance for AP

The parameters configured for Load Balance can help to distribute the traffic for all of the access points registered to Vigor router. Thus, the bandwidth will not be occupied by certain access points.

AP Load Balance (Traffic overload)

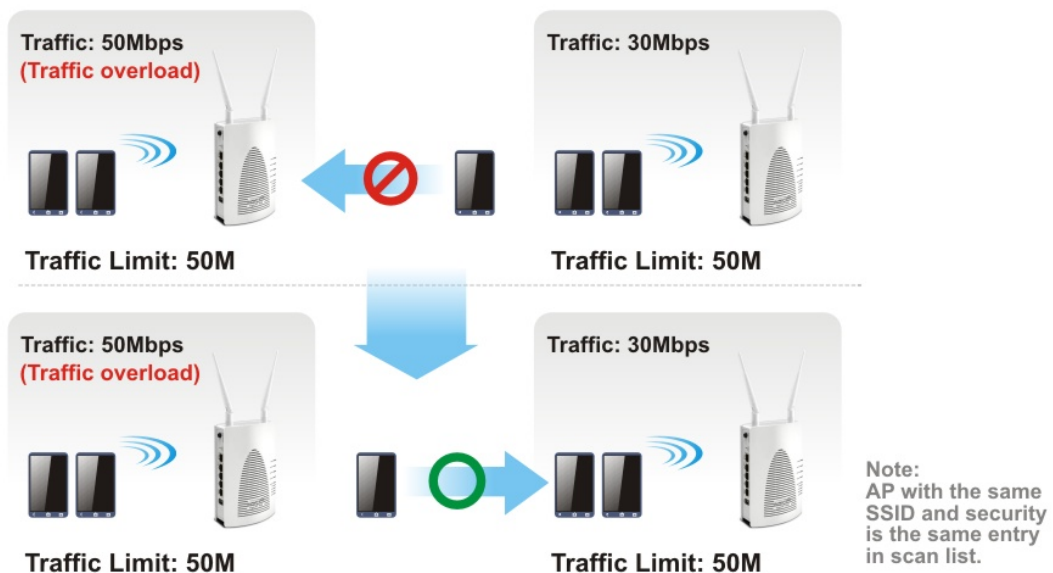

Web User Interface

- Central Management
- AP
 - Dashboard
 - Status
 - WLAN Profile
 - AP Maintenance
 - Traffic Graph
 - Event Log
 - Total Traffic
 - Station Number
 - Load Balance
- Switch

V-5-1 Dashboard

This page shows VigorAP's information about **Status**, **Event Log**, **Total Traffic** or **Station Number** by displaying VigorAP icon, text and histogram. Just move and click your mouse cursor on Status, Event Log, Total Traffic or Station Number. Corresponding web pages will be open immediately.

Central Management >> AP >> Dashboard

Status



192.168.1.10
VigorAP960C

Event Log

2000-01-05 17:20:18	[APM]	[VigorAP960C_426E1E]	has no res
2000-01-05 17:20:18	[APM]	[VigorAP960C_426E1E]	Query Stat
2000-01-05 17:20:22	[APM]	[VigorAP960C_426E1E]	has no res
2000-01-05 17:20:22	[APM]	[VigorAP960C_426E1E]	Apply Load
2000-01-05 17:20:26	[APM]	[VigorAP960C_426E1E]	has no res
2000-01-05 17:20:26	[APM]	[VigorAP960C_426E1E]	Query Stat
2000-01-05 17:20:42	[APM]	[VigorAP960C_426E1E]	Apply Load
2000-01-05 17:20:52	[APM]	[VigorAP960C_426E1E]	Query Stat
2000-01-05 17:21:16	[APM]	[VigorAP960C_426E1E]	GET temper
2000-01-05 17:21:37	[APM]	[VigorAP960C_426E1E]	GET temper
2000-01-05 17:21:54	[APM]	[VigorAP960C_426E1E]	Query Stat
2000-01-05 17:22:54	[APM]	[VigorAP960C_426E1E]	Query Stat
2000-01-05 17:23:55	[APM]	[VigorAP960C_426E1E]	Query Stat
2000-01-05 17:24:56	[APM]	[VigorAP960C_426E1E]	Query Stat
2000-01-05 17:25:55	[APM]	[VigorAP960C_426E1E]	Query Stat
2000-01-05 17:26:38	[APM]	[VigorAP960C_426E1E]	GET temper
2000-01-05 17:26:56	[APM]	[VigorAP960C_426E1E]	Query Stat
2000-01-05 17:27:56	[APM]	[VigorAP960C_426E1E]	Query Stat
2000-01-05 17:28:57	[APM]	[VigorAP960C_426E1E]	Query Stat

Total Traffic

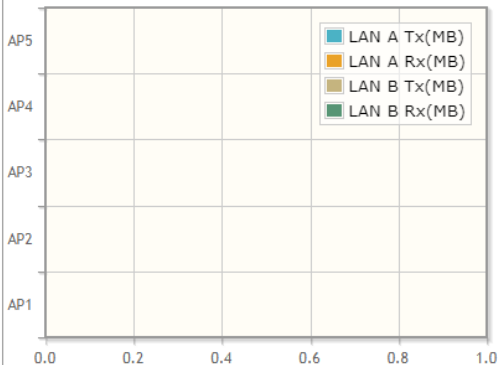

Station Number

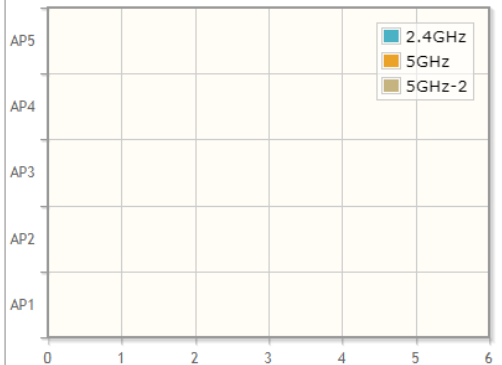

AP1-- IP:192.168.1.10 Device Name:VigorAP960C

AP1-- IP:192.168.1.10 Device Name:VigorAP960C

Note:

Only browser supporting [HTML5](#) can display dashboard correctly.

To access into the web user interface of VigorAP, simply move your mouse cursor on the VigorAP icon and click it. The system will guide you to access into the web user interface of VigorAP.

V-5-2 Status

This page displays current status (online, offline or SSID hidden, IP address, encryption, channel, version, password and etc.) of the access points managed by Vigor router. Please open **Central AP Management>>Function Support List** to check what AP Models are supported.

Central Management >> AP >> Status

Index	Device Name	IP Address	SSID	Ch.	STA List	Uptime	Ver.	Password
 1	VigorAP960C	192.168.1.10	DrayTek-426E1E DrayTek-426E1E	11 36	0/128 0/128	0d 00:13	1.3.0	<input type="text" value="Password"/> <input type="button" value="x"/>

Note:

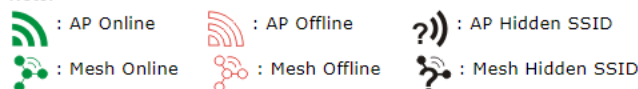

Maximum support 50 APs.

1. Display the overall mesh network information instead of the each AP in the mesh network.
2. When AP Devices connect via an intermediary switch, please ensure that UDP:4944 port and the HTTP port of AP Devices are not blocked so that the AP status can be retrieved.

Available settings are explained as follows:

Item	Description
Index	Click the index number link for viewing the settings summary of the access point.
Device Name	The name of the AP managed by Vigor router will be displayed here.
IP Address	Display the true IP address of the access point.
SSID	Display the SSID configured for the access point(s) connected to Vigor3912.
Ch.	Display the channel used by the access point.
STA List	<p>Display the number of wireless clients (stations) connecting to the access point.</p> <p>In which, 0/64 means that up to 64 clients are allowed to connect to the access point. But, now no one connects to the access point.</p> <p>The number displayed on the left side means 2.4GHz; and the number displayed on the right side means 5GHz.</p>
Uptime	Display the duration of the AP powered up.
Ver.	Display the firmware version used by the access point.
Password	<p>Vigor3912 can get related information of the access point by accessing into the web user interface of the access point.</p> <p>This button is used to modify the logging password of the connected access point.</p>

V-5-3 WLAN Profile

WLAN profile is used to apply to a selected access point. It is very convenient for the administrator to configure the setting for access point without opening the web user interface of the access point.

Central Management >> AP >> WLAN Profile

Set to Factory Default								
Profile	Name	Main SSID	Security	Multi-SSID	WLAN ACL	Rate Ctrl	Clone	To AP
1	Default	DrayTek-LAN-A	WPA+WPA2/PSK	Enable	None	None	<input type="checkbox"/>	
2	---	---	---	---	---	---	---	---
3	---	---	---	---	---	---	---	---
4	---	---	---	---	---	---	---	---
5	---	---	---	---	---	---	---	---
6	---	---	---	---	---	---	---	---
7	---	---	---	---	---	---	---	---
8	---	---	---	---	---	---	---	---
9	---	---	---	---	---	---	---	---
10	---	---	---	---	---	---	---	---
11	---	---	---	---	---	---	---	---
12	---	---	---	---	---	---	---	---
13	---	---	---	---	---	---	---	---
14	---	---	---	---	---	---	---	---
15	---	---	---	---	---	---	---	---
16	---	---	---	---	---	---	---	---
17	---	---	---	---	---	---	---	---
18	---	---	---	---	---	---	---	---
19	---	---	---	---	---	---	---	---
20	---	---	---	---	---	---	---	---

Click the number link of the selected profile to modify the content of the profile. Available settings are explained as follows:

Item	Description
Profile	There are five WLAN profiles offered to be configured. Simply click the index number link to open the modification page.
Name	Display the name of the profile. The default profile cannot be renamed.
Main SSID	Display the SSID configured by such wireless profile.
Security	Display the security mode selected by such wireless profile.
Multi-SSID	Enable means multiple SSIDs (more than one) are active. Disable means only SSID1 is active.
WLAN ACL	Display the name of the access control list.
Rate Ctrl	Display the upload and/or download transmission rate.
Clone	It can copy settings from an existing WLAN profile to another WLAN profile. First, you have to check the box of the existing profile as the original profile. Second, click Clone . The following dialog will appear.

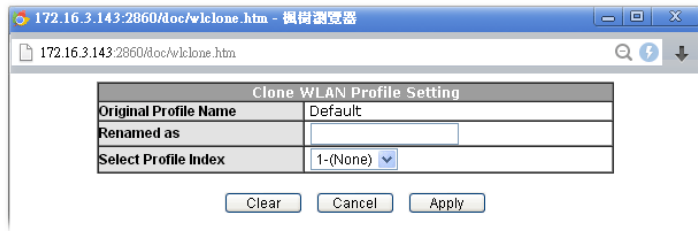

Third, choose the profile index to accept the settings from the original profile. Forth, type a new name in the field of **Renamed as**. Last, click **Apply** to save the settings on this dialog.

The new profile has been created with the settings coming from the original profile.

To AP

Click it to apply the selected wireless profile to the specified Access Point.

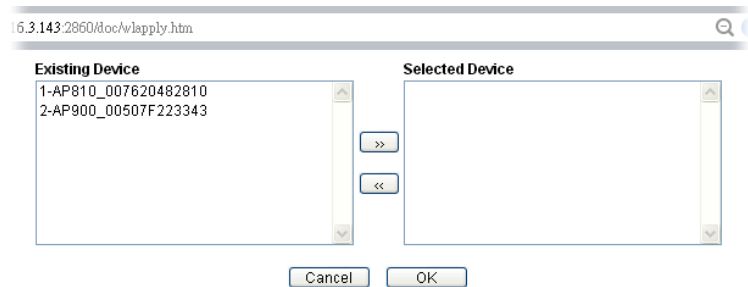

Simply choose the device you want from **Existing Device** field. Click **>>** to move the device to **Selected Device** field. Then, click **OK**.

The selected WLAN profile will be applied to the selected access point immediately. Later the access point will reboot.

To Local

WLAN Profile configured in this page is specified for VigorAP connected to Vigor router.

If required, these settings also can be applied to Vigor router. Select and check one of wireless profiles and click this button to apply the settings onto the WI-Fi wireless settings configured for such Vigor router.

How to edit the wireless LAN profile?

1. Select the WLAN profile (index number 1 to 5) you want to edit.
2. Click the index number link to display the following page.

Central Management >> AP >> WLAN Profile

WLAN Profile Edit

Device Settings	
Profile Name	Default <input type="checkbox"/> Auto Provision
Administrator	admin
Password
2nd Subnet	<input checked="" type="radio"/> Enable <input type="radio"/> Disable
Management VLAN	<input type="checkbox"/> Enable Management VLAN: LAN-A VLAN ID <input type="text" value="0"/> (0 ~ 4095) LAN-B VLAN ID <input type="text" value="0"/> (0 ~ 4095)

WLAN General Setting

	2.4GHz	5GHz	5GHz-2
Wireless LAN	<input checked="" type="radio"/> Enable <input type="radio"/> Disable		
Limit Client	<input type="checkbox"/> Enable Band Steering <input type="text" value="64"/> (3 ~ 128, default: 64)		
Operation Mode	AP		
2.4G Mode	Mixed (11b+11g+11n)		
2.4G Channel	2462MHz (Channel 11)		
Airtime Fairness	<input type="checkbox"/> Enable Airtime Fairness: Triggering Client Number <input type="text" value="2"/> (2 ~ 128, default: 2)		
Band Steering	<input type="checkbox"/> Enable Band Steering: Check Time for WLAN Client 5G Cap. <input type="text" value="15"/> seconds (1 ~ 60, default: 15)		
Roaming	<input type="checkbox"/> Minimum Basic Rate <input type="text" value="1"/> Mbps		
	<input checked="" type="radio"/> Disable RSSI Requirement <input type="radio"/> Strictly Minimum RSSI - <input type="text" value="73"/> dbm (<input type="text" value="42"/> %) (default: -73) <input type="radio"/> Minimum RSSI - <input type="text" value="66"/> dbm (<input type="text" value="60"/> %) (default: -66) with Adjacent AP RSSI over <input type="text" value="5"/> dB (default: 5)		
	<input type="checkbox"/> Enable Fast Roaming(WPA2/802.1x): PMK Cache Period <input type="text" value="10"/> minutes (10 ~ 600, default: 10)		
WMM	<input type="radio"/> Enable <input checked="" type="radio"/> Disable		
Tx Power	100%		
Channel Width	Auto 20/40 MHz		

Note:

1. Administrator can contain only a-z A-Z 0-9 ,.;<>+|=|?@#~`\$%_-'[]{}^!()
2. Password can contain only a-z A-Z 0-9 ,.;<>+|=|?@#~`\$%_-'[]{}^!()
3. The setting of 5GHz-2 band only takes effect to tri-band models.
4. AP will ignore the change if you apply the unsupported channel due to different countries and models.

Cancel Next



Info

The function of Auto Provision is available for the default WLAN profile.

- After finished the general settings configuration, click **Next** to open the following page for 2.4G wireless security settings.

Central Management >> AP >> WLAN Profile

SSID1	SSID2	SSID3	SSID4
2.4GHz SSID			
Active	<input checked="" type="radio"/> Enable <input type="radio"/> Disable		
SSID	DrayTek-LAN-A	LAN-A ▾	<input type="checkbox"/> Hide SSID
VLAN	0 (0:untag)		
Isolate	<input type="checkbox"/> From LAN <input type="checkbox"/> From Member		
Security Settings			
Encryption	WPA2/WPA Personal ▾		
	Set up RADIUS Server if 802.1X is enabled.		
	WPA		
	WPA Algorithms	<input type="radio"/> TKIP <input type="radio"/> AES <input checked="" type="radio"/> TKIP/AES	
Pass Phrase	*****		
Key Renewal Interval	3600	Seconds	
WEP			
Setup WEP Key if WEP is enabled.			
802.1X WEP <input type="radio"/> Enable <input checked="" type="radio"/> Disable			
Access Control			
Mode	None ▾		
List			
	Client's MAC Address : <input type="text"/> : <input type="text"/> : <input type="text"/> : <input type="text"/> : <input type="text"/> : <input type="text"/>		
<input type="button" value="Add"/> <input type="button" value="Delete"/> <input type="button" value="Edit"/> <input type="button" value="Cancel"/>			
Bandwidth Limit			
Status	<input type="radio"/> Enable <input checked="" type="radio"/> Disable		Auto Adjustment <input type="radio"/> Enable <input checked="" type="radio"/> Disable
Upload	0 Kbps	Download	0 Kbps
Station Control			
Status	<input type="radio"/> Enable <input checked="" type="radio"/> Disable		
Connection Time	1 hour ▾	Reconnection Time	1 hour ▾

Note:

SSID can contain only A-Z a-z 0-9 _ - . @ # \$ % *

Backup ACL Cfg : <input type="button" value="Backup"/>	Upload From File: <input type="button" value="選擇檔案"/> 未選擇任何檔案	<input type="button" value="Restore"/>
--	---	--

- After finished the above web page configuration, click **Next** to open the following page for 5G wireless security settings.

Central Management >> AP >> WLAN Profile

5G SSID1		5G SSID2		5G SSID3		5G SSID4		
5GHz SSID								
Active	<input checked="" type="radio"/> Enable <input type="radio"/> Disable							
SSID	DrayTek-5G		LAN-A		<input type="checkbox"/> Hide SSID			
VLAN	0 (0:untag)							
Isolate	<input type="checkbox"/> From LAN <input type="checkbox"/> From Member							
Security Settings								
Encryption	Disable							
	Set up RADIUS Server if 802.1X is enabled.							
	WPA							
	WPA Algorithms			<input type="radio"/> TKIP <input type="radio"/> AES <input checked="" type="radio"/> TKIP/AES				
	Pass Phrase			Max: 64 characters				
Key Renewal Interval			3600 Seconds					
WEP								
Setup WEP Key if WEP is enabled.								
802.1X WEP			<input type="radio"/> Enable <input checked="" type="radio"/> Disable					
Access Control								
Mode	None							
List	<div style="border: 1px solid gray; height: 40px; width: 100%;"></div>							
	Client's MAC Address : <input type="text"/> : <input type="text"/> : <input type="text"/> : <input type="text"/> : <input type="text"/> : <input type="text"/>							
	Add		Delete		Edit		Cancel	
Bandwidth Limit								
Status	<input type="radio"/> Enable <input checked="" type="radio"/> Disable			Auto Adjustment		<input type="radio"/> Enable <input checked="" type="radio"/> Disable		
Upload	0 Kbps			Download		0 Kbps		
Station Control								
Status	<input type="radio"/> Enable <input checked="" type="radio"/> Disable							
Connection Time	1 hour			Reconnection Time		1 hour		

Note:

- 5GHz SSID Configuration only work with VigorAP800 v1.1.1 and newer APM Client.
- SSID can contain only A-Z a-z 0-9 _ - . @ # \$ % *

Backup ACL Cfg : <input type="button" value="Backup"/>	Upload From File: <input type="button" value="選擇檔案"/> 未選擇任何檔案	<input type="button" value="Restore"/>
--	---	--

- When you finished the above web page configuration, click **Finish** to exit and return to the first page. The modified WLAN profile will be shown on the web page.

Central Management >> AP >> WLAN Profile

Set to Factory Default									
Profile	Name	Main SSID	Security	Multi-SSID	WLAN ACL	Rate Ctrl	Clone	To AP	To Local
1	Default	DrayTek-LAN-A	WPA+WPA2/PSK	Enable	None	None			
2	123	DrayTek	Disable	Disable	None	None			
3	---	---	---	---	---	---	---	---	---
4	---	---	---	---	---	---	---	---	---
5	---	---	---	---	---	---	---	---	---

V-5-4 AP Maintenance

Vigor router can execute configuration backup, configuration restoration, firmware upgrade and remote reboot for the APs managed by the router. It is very convenient for the administrator to process maintenance without accessing into the web user interface of the access point.



Info

Config Backup can be performed to one AP at one time. Others functions (e.g., Config Restore, Firmware Upgrade, Remote Reboot can be performed to more than one AP at one time by using Vigor2962.

Central Management >> AP >> AP Maintenance

AP Maintenance

Select Action
 Action Type: ▼
 File/Path: 未選擇任何檔案

Select Device
 Existing Device Selected Device

Available settings are explained as follows:

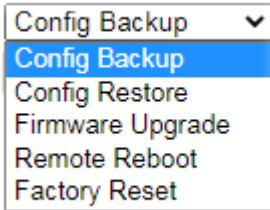
Item	Description
Action	<p>There are four actions provided by Vigor router to manage the access points.</p>  <p>Vigor router can backup the configuration of the selected AP, restore the configuration for the selected AP, perform the firmware upgrade of the selected AP, reboot the selected AP remotely and perform the factory reset for the selected AP.</p>
File/Path	Specify the file and the path which will be used to perform Config Restore or Firmware Upgrade.
Select Device	Display all the available access points managed by Vigor

	router. Simply click << or >> to move the device(s) between Select Device and Selected Device areas.
Selected Device	Display the access points that will be applied by such function after clicking OK.

After finishing all the settings here, please click **OK** to perform the action.

V-5-5 Traffic Graph

Click **Traffic Graph** to open the web page. Choose one of the managed Access Points, LAN-A or LAN-B, daily or weekly for viewing data transmission chart. Click **Refresh** to renew the graph at any time.

Central Management >> AP >> Traffic Graph

Enable

Show Chart: Refresh Min(s): | [Refresh](#) |

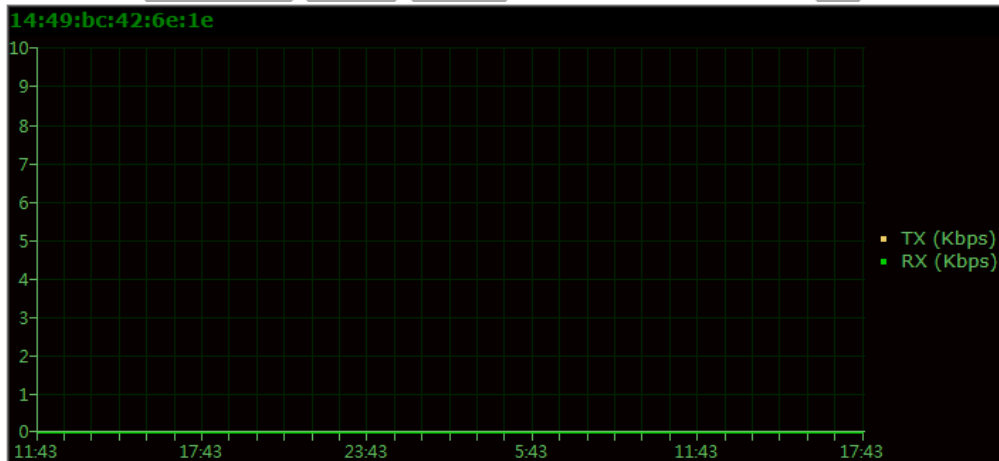

Note:

Enabling/Disabling AP Traffic Graph will also Enable/Disable the External Devices Function.

The horizontal axis represents time; the vertical axis represents the transmission rate (in kbps).



Info

Enabling/Disabling such function will also enable/disable the External Devices function.

V-5-6 Event Log

Time and event log for all of the APs managed by Vigor router will be shown on this page. It is useful for troubleshooting if required.

Central Management >> AP >> Event Log

All Event Log ▼

| [Clear](#) | [Refresh](#) |

Time	APM Event Log
2000-01-12 00:34:50	[APM] [MK-AP 902_3D5490] Query Status success
2000-01-12 00:34:53	[APM] [MK-AP 902_3D5490] Apply Load Balance settings success
2000-01-12 00:35:19	[APM] [MK-AP 902_3D5490] Apply Rogue AP Detection settings success
2000-01-12 00:35:49	[APM] [MK-AP 902_3D5490] GET temper/traffic index success
2000-01-12 00:35:54	[APM] [MK-AP 902_3D5490] Query Status success
2000-01-12 00:36:10	[APM] [MK-AP 902_3D5490] GET temper/traffic data success
2000-01-12 00:36:54	[APM] [MK-AP 902_3D5490] Query Status success
2000-01-12 00:37:53	[APM] [MK-AP 902_3D5490] Query Status success
2000-01-12 00:38:53	[APM] [MK-AP 902_3D5490] Query Status success
2000-01-12 00:39:52	[APM] [MK-AP 902_3D5490] Query Status success
2000-01-12 00:40:52	[APM] [MK-AP 902_3D5490] Query Status success
2000-01-12 00:41:08	[APM] [MK-AP 902_3D5490] GET temper/traffic data success
2000-01-12 00:41:22	[APM] [MK-AP 902_3D5490] Query Status success
2000-01-12 00:42:25	[APM] [MK-AP 902_3D5490] Query Status success
2000-01-12 00:46:06	[APM] [MK-AP 902_3D5490] GET temper/traffic data success
2000-01-12 00:51:03	[APM] [MK-AP 902_3D5490] GET temper/traffic data success
2000-01-12 00:56:01	[APM] [MK-AP 902_3D5490] GET temper/traffic data success
2000-01-12 01:00:59	[APM] [MK-AP 902_3D5490] GET temper/traffic data success
2000-01-12 01:05:57	[APM] [MK-AP 902_3D5490] GET temper/traffic data success
2000-01-12 01:10:55	[APM] [MK-AP 902_3D5490] GET temper/traffic data success
2000-01-12 01:15:53	[APM] [MK-AP 902_3D5490] GET temper/traffic data success
2000-01-12 01:16:07	[APM] [MK-AP 902_3D5490] Query Status success
2000-01-12 01:18:21	[APM] [MK-AP 902_3D5490] Query Status success
2000-01-12 01:20:45	[APM] [MK-AP 902_3D5490] GET temper/traffic data success
2000-01-12 01:21:13	[APM] [MK-AP 902_3D5490] GET temper/traffic data success
2000-01-12 01:23:10	[APM] [MK-AP 902_3D5490] Apply Rogue AP Detection settings success
2000-01-12 01:25:01	[APM] [MK-AP 902_3D5490] Get Rogue AP Detection data failed
2000-01-12 01:25:22	[APM] [MK-AP 902_3D5490] Get Rogue AP Detection data failed
2000-01-12 01:25:42	[APM] [MK-AP 902_3D5490] Get Rogue AP Detection data failed
2000-01-12 01:26:03	[APM] [MK-AP 902_3D5490] Get Rogue AP Detection data failed
2000-01-12 01:26:09	[APM] [MK-AP 902_3D5490] GET temper/traffic data success
2000-01-12 01:26:23	[APM] [MK-AP 902_3D5490] Get Rogue AP Detection data failed

Note:

1. Only browser supporting **HTML5** can display Event Log correctly.
2. The APs Log can be refreshed after at least 30 seconds.

V-5-7 Total Traffic

Such page will display the total traffic of data receiving and data transmitting for VigorAPs managed by Vigor router.

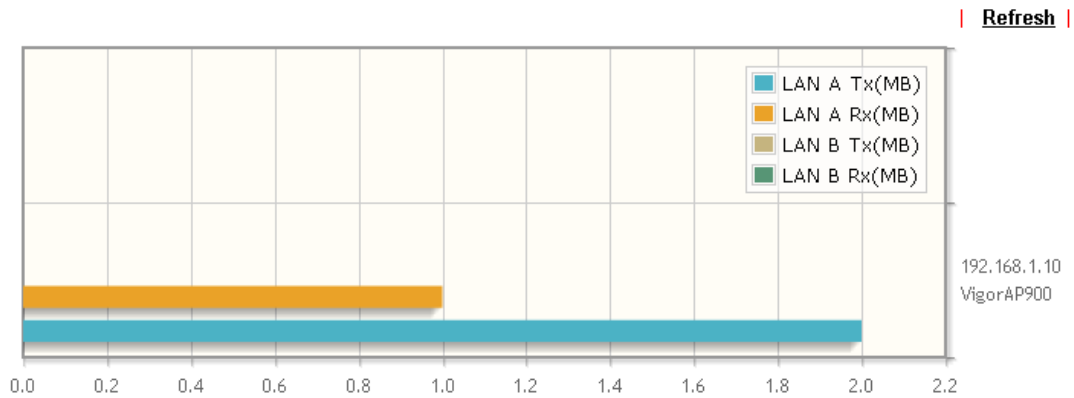

Note: Only browser supporting [HTML5](#) can display Total Traffic correctly.

V-5-8 Station Number

The total number of the wireless clients will be shown on this page, no matter what mode of wireless connection (2.4G WLAN or 5G WLAN) used by wireless clients to access into Internet through VigorAP.

Central AP Management >> Station Number

Hourly Records(2 Hours)

Station Number

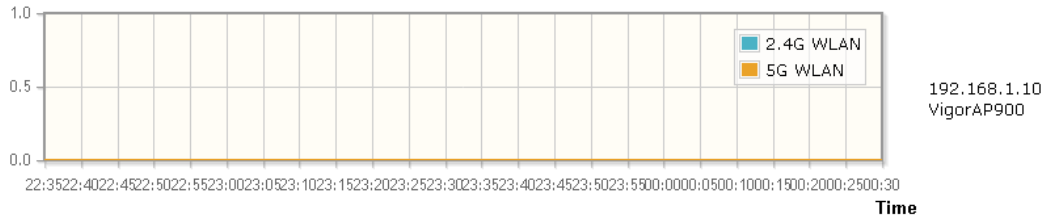

Note: Only browser supporting [HTML5](#) can display Station Number correctly.

V-5-9 Load Balance

The parameters configured for Load Balance can help to distribute the traffic for all of the access points registered to Vigor router. Thus, the bandwidth will not be occupied by certain access points.

Central Management >> AP >> Load Balance

AP Load Balance By Station Number or Traffic ▼

Station Number Threshold

Wireless LAN (2.4GHz) (3-128)
 Wireless LAN (5GHz) (3-128)
 Wireless LAN (5GHz-2) (3-128)

Traffic Threshold

Upload Limit User defined ▼ bps (Default unit: K)
 Download Limit User defined ▼ bps (Default unit: K)

Action When Threshold Exceeded

Stop accepting new connections
 Dissociate existing station by longest idle time
 Dissociate existing station by worst signal strength if it is less than dBm (%)

Choose to Apply

All APs ▼
All APs
Specific APs

Note: Specific APs
 The maximum station number of Wireless LAN (2.4GHz) will be applied to both Wireless LAN (2.4GHz) and Wireless LAN (5GHz) if the firmware version of AP900 is less than or equal to 1.1.4.1.

Available settings are explained as follows:

Item	Description
AP Load Balance	<p>It is used to determine the operation mode when the system detects overload between access points.</p> <p>Disable - Disable the function of AP load balance.</p> <p>By Station Number -The operation of load balance will be executed based on the station number configured in this page. It is used to limit the allowed number for the station connecting to the access point. The purpose is to prevent lots of stations connecting to access point at the same time and causing traffic unbalanced. Please define the required station number for WLAN (2.4GHz) and WLAN (5GHz) separately.</p> <p>By Traffic - The operation of load balance will be executed according to the traffic configuration in this page.</p> <p>By Station Number or Traffic - The operation of load balance will be executed based on the station number or the traffic configuration.</p>
Station Number	Set the number of stations as a threshold to activate AP load

Threshold	balance.
Traffic Threshold	<p>Upload Limit -Use the drop down list to specify the traffic limit for uploading.</p> <p>Download Limit - Use the drop down list to specify the traffic limit for downloading.</p>
Action When Threshold Exceeded	<p>Stop accepting new connections - When the number of stations or the traffic reaches the threshold defined in this web page, Vigor router will stop any new connection asked by other access point.</p> <p>Dissociate existing station by longest idel time - When the access point is overload (e.g., reaching the limit of station number or limit of network traffic), it will terminate the network connection of the client's station which is idle for a longest time.</p> <p>Dissociate existing station by worst signal strength if it is less than - When the access point is overload (e.g., reaching the limit of station number or limit of network traffic), it will terminate the network connection of the client's station with the weakest signal.</p>
Choose to Apply	<p>Determine which AP shall be applied with the load balance.</p> <p>All APs - All APs shall be applied with the load balance.</p> <p>Specific APs - The function of load balance will be applied to the AP specified in this field.</p>

After finishing all the settings here, please click **OK** to save the configuration.

V-6 Central Management (Switch)

Vigor router can manage lots of VigorSwitch devices connected to it. Through profile and group settings, the administrator can execute firmware/configuration backup, restore for VigorSwitch device, reboot the device or return to factory default settings of VigorSwitch at one time.

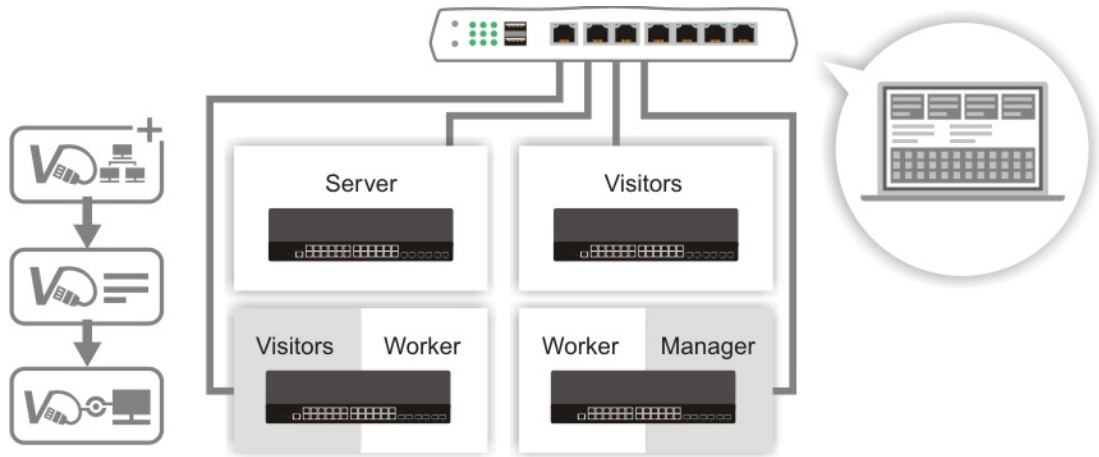

Web User Interface

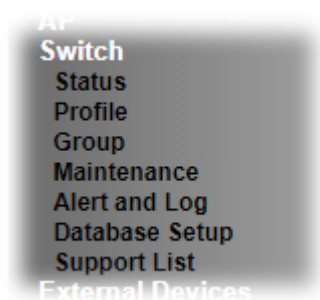

V-6-1 Status

V-6-1-1 Switch Status

Such page displays information, including Group, Switch name, IP address, model, System Up Time, Port in Use, Clients, and Firmware Version of VigorSwitch connected to Vigor2962 series.

Before checking the switch status, go to **Central Management>>External Device** to enable **External Device Auto Discovery**. Wait for the system to display available device(s).

Central Management >> External Device

- External Device Syslog
- External Device Auto Discovery

External Devices Connected

| [Refresh](#) |

Below shows available devices that connected externally:

Off Line VigorAP960C, VigorAP960C, Connection Uptime:00:11:06

IP Address:192.168.1.10:80

Account

Clear

On Line G2280, Connection Uptime:00:08:46

IP Address:192.168.1.11:80

Account

Clear

For security reason:

If you have changed the administrator password on External Device, please click the **Account** button to retype new username and password. Otherwise, the router will be unable to monitor the External Device device properly. Click the **Clear** button to Clear the off-line information and account information.

OK

Later, open **Central Management>>Switch>>Status**. Available VigorSwitch to be managed by such router will be listed under the New Switch List.

[Switch Status](#)
[Switch Hierarchy](#)
[Detailed Info](#)
[TR069 Setting](#)
[Refresh](#)

View Group:

Status

Group	Switch Name	IP Address	Model	System Up Time	Port in Use	Clients	Firmware Version	Last Process Status
-------	-------------	------------	-------	----------------	-------------	---------	------------------	---------------------

New Switch List

Index	Switch Name	IP Address	MAC Address	Model	Firmware Version	Add Device
1	G2280	192.168.1.11	00:1D:AA:0C:CD:08	G2280	2.6.6	Add New

Note:
[Supported VigorSwitch model and firmware version](#)



Info

VigorSwitch listed below Status means the switch is managed by Vigor3912; VigorSwitch listed below New Switch List means it is not managed by Vigor3912 yet.

Click Add to make the selected VigorSwitch to be managed by Vigor router.

[Switch Status](#)
[Switch Hierarchy](#)
[Detailed Info](#)
[TR069 Setting](#)
[Refresh](#)

View Group:

Status

Group	Switch Name	IP Address	Model	System Up Time	Port in Use	Clients	Firmware Version	Last Process Status
Default	G2280	192.168.1.11	G2280	1:01:19	1/28	0	2.6.6	Process Successfully

Note:
[Supported VigorSwitch model and firmware version](#)

Available settings are explained as follows:

Item	Description
Group	Display the name link of the group. You can click the link to modify the group settings if required.
Switch Name	Display the name link of VigorSwitch. You can click the name link to access into the switch profile.
IP Address	Display the IP address of VigorSwitch.
Model	Display the model name of VigorSwitch.
System Up Time	Display the time accumulated since this Vigorwitch is powered up.
Port in Use	Display how many devices connected to VigorSwitch.
Clients	Display the number of LAN ports used in VigorSwitch.
Firmware Version	Display the firmware version that VigorSwitch current used.
Add	Such button will appear only when there is more than one switch connected to Vigor3912. The one under New Switch List is allowed to be managed under current used group. Simply click Add.

Central Management >> Switch >> Status

Switch Status | Switch Hierarchy | Detailed Info | TR069 Setting | Refresh

Status

View Group: All

Group	Switch Name	IP Address	Model	System Up Time	Port in Use	Clients	Firmware Version	Last Process Status
New Switch List								
Index	Switch Name	IP Address	MAC Address	Model	Firmware Version	Add Device		
1	G2280	192.168.1.11	00:1D:AA:0C:CD:08	G2280	2.6.6	Add New		

Note:
Supported VigorSwitch model and firmware version

It will be better to group VigorSwitch devices with the same model.

V-6-1-2 Switch Hierarchy

This page displays the hierarchy of VigorSwitch(es) managed under Vigor2962.

Central Management >> Switch >> Status

Switch Status | Switch Hierarchy | Detailed Info | Refresh

VigorSwitch G2280
192.168.1.1
G2280

Port : 2
Description : Uplink
IP Address : 192.168.1.1
MAC Address : 14:49:BC:0D:1F:48

Central Management >> Switch >> Status

Switch Status | Switch Hierarchy | Detailed Info | Refresh

VigorSwitch G2280
192.168.1.1
G2280

Port : 8
Description : ---
IP Address : ---
MAC Address : ---
Port Control: Enable Port
OK

V-6-1-3 Detailed Info

This page displays the hierarchy of VigorSwitch(es) managed under Vigor3912.

Central Management >> Switch >> Status

[Switch Status](#)
[Switch Hierarchy](#)
[Detailed Info](#)
[TR069 Setting](#)
[Refresh](#)

Switch List

Index	Switch Name	IP	Model	MAC
1	G2280	192.168.1.15	G2280	00:1D:AA:0C:CD:08

Search

Uplink Device	Port	IP	MAC	Name/Description
Vigor Router	3	192.168.1.15	00:1D:AA:0C:CD:08	G2280

Note:

Vigor router only temporarily records the IP address and MAC address of the client connects to the switch, record will be discarded after the client leaves the network.

Available settings are explained as follows:

Item	Description
Switch List	<p>Displays the index number, switch name, IP address, model name and MAC address of the VigorSwitch device.</p> <p>Switch Name - The name link allows you to access into the web user interface of the Vigor Switch.</p> <p>IP - Displays the IP address of the switch.</p> <p>Model - Displays the model name of the switch.</p> <p>MAC - Displays the MAC address of the switch.</p>
Search	<p>Search - After specifying IP address, MAC address or name of the switch, click the Search button to find out the device and display the searching result on this page.</p> <p>Uplink Device - Displays the name of the server that Vigor switch connects to.</p> <p>Port - Indicates the port where the switch is connected to the router. This number link allows you to click to view more detailed information of the searched device.</p>

Click the port number link (e.g., 3) to open the following page. Detailed information of the name, port number, IP address, MAC address, description, type, VLAN number, PVID value and PoE capability of the switch will be shown on this page.

Switch List

Index	Switch Name	IP	Model	MAC
1	G2280	192.168.1.11	G2280	00:1D:AA:0C:CD:08

Search

IP

G2280



Switch	Port	IP	MAC	Description	Type	VLAN	PVID	PoE
G2280	3	---	---		access		0	---

Devices Connect to this port

Index	IP	MAC	Netbios Name
1	---	---	---

Note: Vigor router only temporarily records the IP address and MAC address of the client connects to the switch, record will be discarded after the client leaves the network.

In addition, this page will display the basic information (IP address, MAC address and Netbios Name) of "other" devices connected to this switch.

V-6-1-4 TR069 Setting

In addition to HTTP/HTTPS, the Vigor router is able to manage the VigorSwitch with the protocol of TR-069.

Central Management >> Switch >> Status

Switch Status	Switch Hierarchy	Detailed Info	TR069 Setting	Refresh
SWM PORT	<input type="text" value="8003"/>			
Username	<input type="text" value="acs"/>			
Password	<input type="password" value="....."/>			
<input type="button" value="OK"/>				

Available settings are explained as follows:

Item	Description
SWM Port	The default value is 8003. In the event of port conflicts, change the port number.
Username	Displays the username that the Vigor switch will use to connect to this router. Keep the default value.
Password	Displays the password that the Vigor switch will use to connect to this router. Keep the default value.

V-6-2 Profile

This page will show general information, such as name, group, IP address, MAC address, model and password of VigorSwitch only when it connects to Vigor2962 series. By clicking the index number link, a profile setting page for that switch will be shown. Note that each profile represents one VigorSwitch.

Central Management >> Switch >> Profile



Profile List

Index	Name	Group	IP Address	MAC Address	Model	Password	Process Status	Delete Profile
1	G2280	Default,	192.168.1.11	00:1D:AA:0C:CD:08	G2280	<input type="button" value="Password"/>	Process Successfully	<input checked="" type="checkbox"/>

Available settings are explained as follows:

Item	Description
Index	Click the number link to access into the switch profile. Note: Each connected VigorSwitch will have one setting profile. If there are many switches connected to Vigor3912, different index number will be used to represent different VigorSwitch.
Name	Display the user defined name of VigorSwitch.
Group	Display the group name of VigorSwitch(es).
IP Address	Display the IP address of VigorSwitch.
MAC Address	Display the MAC address of VigorSwitch.
Model	Display the model name of VigorSwitch.
Password	Click it to display the account information including username and password.
Delete Profile	Click the mark of "X" to delete the switch profile.

To edit profile for the selected switch:

1. Click index number link (e.g. #1) to open the following page.

Switch Profile 1 | [Get Setting from External Switch](#) |

[Set to Factory Default](#) |

General	VLAN	Port
Switch Name	<input type="text" value="G2280"/>	
Comment	<input type="text"/>	
Trap Community Name	<input type="text" value="public"/>	
Login Password	<input type="password" value="....."/>	<input type="button" value="Show"/>
IP Address	DHCP 192.168.1.11	

Note:

The router configuration will be updated when getting profile settings from external switch.
We will not copy settings of rate limit while copy configuration, because the format of rate limit are different between each model.

Available settings are explained as follows:

Item	Description
Switch Name	Type a name for the Switch. The purpose of name is used for identification. It is useful when there are many VigorSwitch (same modes) devices connecting to Vigor3912 series.
Comment	Enter the text in such field if additional explanation for the switch is required.
Trap Community Name	Enter the text in such field as trap community.
Login Password	Display the original login password for the VigorSwitch. However, if Group Password (in Central Management >>Switch>>Group) is configured with other string, then such field is not allowed to type any other password. And only the group password will be shown, instead.
IP Address	Display the dynamic IP address (of the connected switch) assigned by Vigor3912.
Save	Click it to save the settings.
Cancel	Click it to return to previous web page without saving the setting changes.
Send to Device	Click it to transfer the configuration change (e.g, login password, switch name, etc.) to the VigorSwitch immediately.

- After finished the settings, click **VLAN** tab to open following page.
Blank page due to LAN>>VLAN not configured previously:

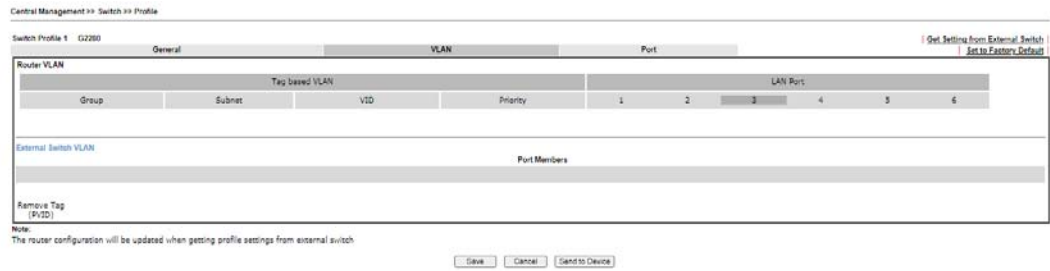

Setting page with LAN>>VLAN configured previously:

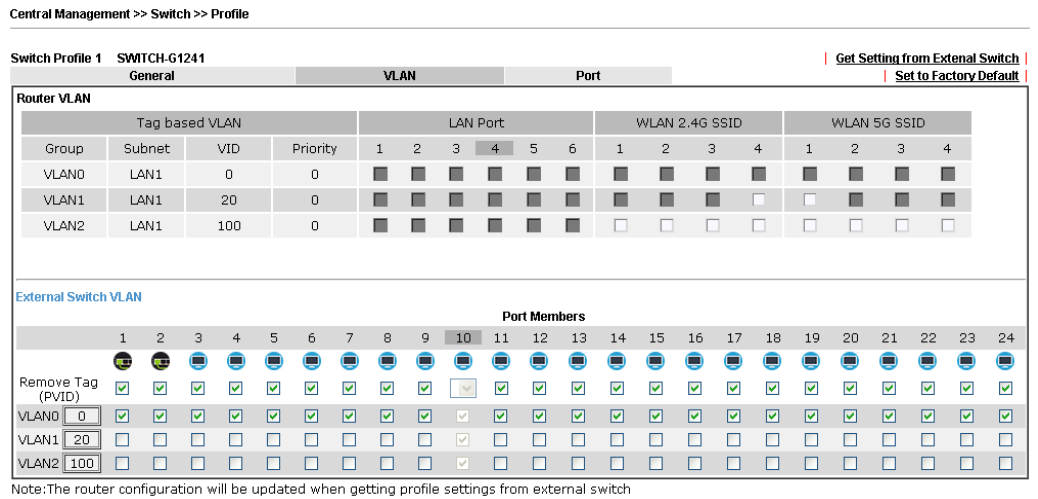

- Click **Save** to save VLAN configuration. Then, click **Port** tab to access the following page:

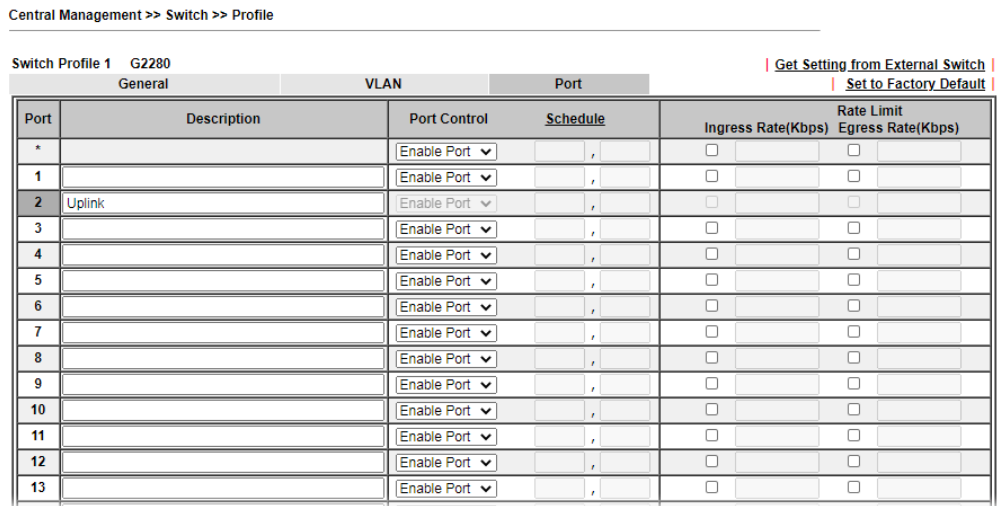

Available settings are explained as follows:

Item	Description
Description	If required, type a brief description to explain the device connected to VigorSwitch via the LAN port.
Port Control	Disable Port - The port (e.g, Port 2 in this case) which is used to connect VigorSwitch and Vigor3912 will not be shutdown by Vigor3912. Other LAN ports of VigorSwitch allow to connect to any LAN device. When it is checked, after clicking Save, the network connection between that device and VigorSwitch will be terminated.

	By Schedule - Two schedule profiles can be specified here to force Vigor3912 executing specific action to VigorSwitch.
Rate Limit	Check the box for typing the ingress rate / egress rate for the selected VigorSwitch. After clicking Save , the value modified in this page will be written to VigorSwitch and enabled.

- Click **Save** to save the changes and then click **Send to Device**. Settings will be sent to VigorSwitch immediately.

Central Management >> Switch >> Profile

Switch Profile 1 G2280 | Get Setting from External Switch |
| Set to Factory Default |

General	VLAN	Port
Post Settings to Vigor Switch		
		

Note:

- The router configuration will be updated when getting profile settings from external switch.
- Double quotation mark (") is not supported in Description columns.

V-6-3 Group

Different switches can be classified into different group(s). Specific password for a group can be defined and applied to every switch under that group.

Through the common password setting, it is not necessary for the system administrator to remember various login passwords to access into different VigorSwitch devices.

Central Management >> Switch >> Group

Index	Group Name	Member Switch
1	Default	G2280(192.168.1.10)
2		
3		
4		
5		
6		
7		
8		
9		
10		

Click any index number link to create a new switch group.

Index 1:

Available settings are explained as follows:

Item	Description
Group Name	Type a name as the group name. Different switches can be classified within a group.
Group Password	Type a password that administrator can use to access into the managed VigorSwitch connecting to Vigor3912. All of the switches under the same group can be accessed into via such group password.
Existing Switch	Display all of the VigorSwitch devices connecting to Vigor3912.
Member Switch	Choose the switches you want to group and click the button ">>" to move the selected devices onto the field of Member Switch. Devices under Member Switch will be grouped under such group profile.
OK	Click it to save the configuration.
Cancel	Click it to exit the setting page without saving any change.

V-6-4 Maintenance

Such feature can execute configuration backup, restore of selected VigorSwitch device(s) or reboot the VigorSwitch devices remotely or reset the VigorSwitch devices with factory default settings, without accessing into the web user interface of VigorSwitch respectively. It is convenient for system administrator to manage VigorSwitch devices.

Central Management >> Switch >> Maintenance

Available settings are explained as follows:

Item	Description
Select Action	Action Type - Four actions including configuration backup, configuration restore, remote reboot and factory reset are offered by Vigor3912 to perform on VigorSwitch. File/Path - Click the button to find out the required file.
Selected Device	Use the drop down list to specify a VigorSwitch. Then the MAC address and IP address related to the device will be displayed on this area.
OK	Click it to immediately perform the action (configuration backup, configuration restore, remote reboot and factory reset) on the device(s) listed in Selected Device.
Cancel	Click it to cancel the setting changes.

V-6-5 Alert and Log

Alert and Log is helpful for the user to understand the abnormal situation occurred in VigorSwitch quickly. When the system detects an error, information of abnormal condition will be recorded to the database; or the system will send an alert to the specified device (via e-mail or SMS) to warn the user.

V-6-5-1 Alert Setup

This page is used to define the name of alert, level of alert (in color), and determine to record the data in the database, or send a notification message to the user based on the level.

Central Management >> Switch >> Alert and Log

Alert Setup Switch and Port Setup Alert Logs

Alert and Log [Set to Factory Default](#)

Index	Enable	Level Name	Color	Create Log	Send Notification	SMS/Email Service object
1	<input checked="" type="checkbox"/>	No Alert max. 15 characters	No Color	No Log	No Notification	
2	<input checked="" type="checkbox"/>	Minor Alert max. 15 characters	<input type="text"/>	Enable	No Notification	
3	<input checked="" type="checkbox"/>	Moderate Alert max. 15 characters	<input type="text" value="Orange"/>	<input checked="" type="checkbox"/>	<input type="checkbox"/>	<input type="text" value="sms alert 1 -"/> <input type="text" value="sms alert 1 -"/> <input type="text" value="sms alert 1 -"/> <input type="text" value="sms alert 1 -"/>
4	<input checked="" type="checkbox"/>	Major Alert max. 15 characters	<input type="text" value="Red"/>	<input checked="" type="checkbox"/>	<input type="checkbox"/>	<input type="text" value="sms alert 1 -"/> <input type="text" value="sms alert 1 -"/> <input type="text" value="sms alert 1 -"/>

Available settings are explained as follows:

Item	Description
Alert and Log	Check it to enable this feature.
Alert Levels and Action	<p>Level Name - Define names for representing the severity of alert event. The default names for index 1 to index 4 will be shown on each setting box. Index 5 to index 8 are reserved for user-defined.</p> <p>Color - Define the color for each level of alert. However, the color of index 1 is No color and unable to be changed.</p> <p>Create Log - Check the box to create log of alert. Such log will be seen on Alert Logs page. Note that No Log for index 1; and log for index 2 is enabled in default.</p> <p>Send Notification - If it is checked, Vigor router's system will send notification to specified phone number via SMS.</p> <p>SMS/Email Service Object - Choose the SMS object which will get the SMS from Vigor router. Up to 4 objects can be</p>

selected at one time.

V-6-5-2 Switch and Port Setup

This page defines enabling switch alert and/or port alert for each switch.

Central Management >> Switch >> Alert and Log

Alert Setup	Switch and Port Setup	Alert Logs			
Index	Switch Name	IP	Model	Switch Alert	Port Alert
1	G2121	192.168.1.13	G2121	Enable ▾	Enable ▾

OK

Cancel

Available settings are explained as follows:

Item	Description
Switch Alert	Enable - Check it to enable alert mechanism for VigorSwitch.
Port Alert	Enable - Check it to enable alert mechanism for each port of VigorSwitch.

Click the Switch Name link (e.g., G2121 in this case) to get detailed settings.

Central Management >> Switch >> Alert and Log

Alert Setup	Switch and Port Setup	Alert Logs			
Index	Switch Name	IP	Model	Switch Alert	Port Alert
1	G2121	192.168.1.13	G2121	Enable ▾	Enable ▾

G2121

[Set to Factory Default](#)

Switch Alert

Incident	Level
Cold Start	Major Alert ▾
Warm Start	Major Alert ▾
Disconnect	Major Alert ▾
Reconnect	Minor Alert ▾

Port Alert

Port	Description	Device Disconnects	Device Reconnects	Schedule on/off	Shutdown En/Dis
1	Uplink	No Alert ▾	No Alert ▾	No Alert ▾	No Alert ▾
2	DownlinkAP	No Alert ▾	No Alert ▾	No Alert ▾	No Alert ▾
3	phone678	No Alert ▾	No Alert ▾	No Alert ▾	No Alert ▾
4	phone677	No Alert ▾	No Alert ▾	No Alert ▾	No Alert ▾
5	phone676	No Alert ▾	No Alert ▾	No Alert ▾	No Alert ▾
6	cam1F	No Alert ▾	No Alert ▾	No Alert ▾	No Alert ▾

Available settings are explained as follows:

Item	Description
Switch Alert	When VigorSwitch encounters the following alert events, alert mechanism will perform corresponding actions based on the severity level of the incident encountered. Incident - At present, Cold Start, Warm Start, Disconnect

	and Reconnect will be treated as alert events. Level - Specify the severity level for each incident. To defined more severity level for choosing in this page, simply open Central Management>>Switch>>Alert and Log and click Alert Setup.
Port Alert	Port - Available Ethernet ports for the selected VigorSwitch (e.g. , G2280 in this case) will be shown on this page. Each port can be configured with different alert level for different alert event.

V-6-5-3 Alert Logs

The user can get the information by filtering the collective information based on the conditions specified in this page.

Central Management >> Switch >> Alert and Log

Alert Setup	Switch and Port Setup	Alert Logs									
<input type="checkbox"/> Select Columns to Filter Logs											
<table border="1"> <thead> <tr> <th>Level</th> </tr> </thead> <tbody> <tr> <td><input type="checkbox"/> Minor Alert</td> </tr> <tr> <td><input type="checkbox"/> Moderate Alert</td> </tr> <tr> <td><input type="checkbox"/> Major Alert</td> </tr> </tbody> </table>	Level	<input type="checkbox"/> Minor Alert	<input type="checkbox"/> Moderate Alert	<input type="checkbox"/> Major Alert	<table border="1"> <thead> <tr> <th>Type</th> </tr> </thead> <tbody> <tr> <td><input type="checkbox"/> Switch Alert</td> </tr> <tr> <td><input type="checkbox"/> Port Alert</td> </tr> </tbody> </table>	Type	<input type="checkbox"/> Switch Alert	<input type="checkbox"/> Port Alert	<table border="1"> <thead> <tr> <th>Switch</th> </tr> </thead> <tbody> <tr> <td><input checked="" type="radio"/> G2121</td> </tr> </tbody> </table>	Switch	<input checked="" type="radio"/> G2121
Level											
<input type="checkbox"/> Minor Alert											
<input type="checkbox"/> Moderate Alert											
<input type="checkbox"/> Major Alert											
Type											
<input type="checkbox"/> Switch Alert											
<input type="checkbox"/> Port Alert											
Switch											
<input checked="" type="radio"/> G2121											
<input type="button" value="OK"/>											
Alert Logs		Show <input type="text" value="10"/> per page Refresh									
0 Logs Last 24 Hour Last 7 Days											
Index	Level Name	Time	Type	Switch	Port	Incident					

Available settings are explained as follows:

Item	Description
Select Columns to Filter Logs	<p>Level - The alert can be divided into several levels, Minor Alert, Moderate Alert and Major Alert. Check the one(s) you want to check in Alert Logs list.</p> <p>Type - Check the type (switch / port) of the log to be displayed in Alert Logs list.</p> <p>Switch - Switch(es) connecting to Vigor router will be shown in this area. Click the one you need.</p> <p>OK - Click it to save the configuration.</p> <p>Log related to the items selected above will be shown in Alert Logs list.</p>
Alert Logs	This area displays logs (level name, time, type, switch, port, and incident) related to VigorSwitch managed by Vigor router.

V-6-6 Database Setup

The database of switch can be used to record alert logs and traffic history. This page is used to determine if it is necessary for the user information to be recorded in the database of switch.

Central Management >> Switch >> Database Setup

Enable Database to Record alert logs and traffic history

File Path : No USB Disk Detected

Database Usage : N/A

Notification and Action when Storage Exceeded

Notification

Don't send notification

Send notification

Email Notification Object

SMS Notification Object

Action

Stop recording alert logs and traffic history

Backup and clean up all alert logs and traffic history, and start a new record

OK

Note:

In order to prevent data loss, we will start a new record at 45MB.

Available settings are explained as follows:

Item	Description
Enable Database to Record alert logs and traffic history	Check the box to make the database (in USB disk) to record the alert logs and traffic history.
Notification and Action when Storage Exceeded	
Notification	<p>Don't send notification - No notification will be sent out when there is no capacity for storage in USB.</p> <p>Send notification - A notification will be sent out when there is no capacity for storage in USB.</p>
Action	<p>Stop recording user information - When the capacity of log is full, the system will stop recording.</p> <p>Backup and clean up all user infor, and start a new record - Only the newest events will be recorded by the system.</p>

After finished the settings, click OK to save the configuration.

V-6-7 Support List

This page lists all models of VigorSwitch which can be managed by Vigor3912 via Central Management>>Switch.

Central Management >> Switch >> Support List

Model	Status	Firmware Version
Vigor Switch P2261	V	v3.48
Vigor Switch G2260	V	v3.48
Vigor Switch P1280	V	2.2.1
Vigor Switch G1280	V	2.2.1
Vigor Switch P2280	V	2.2.1
Vigor Switch G2280	V	2.2.1
Vigor Switch P2121	V	2.3.2
Vigor Switch G2121	V	2.4.3
Vigor Switch P1092	V	1.04.05
Vigor Switch G1080	V	1.04.05
Vigor Switch P2500	V	2.4.1
Vigor Switch G2500	V	2.4.1
Vigor Switch P2280x	V	2.4.2
Vigor Switch G2280x	V	2.4.2
Vigor Switch P1085	V	2.4.3
Vigor Switch G1085	V	2.4.3
Vigor Switch P2540x	V	2.6.0
Vigor Switch P2540xh	V	2.6.0
Vigor Switch G2540x	V	2.6.0
Vigor Switch P2100	V	2.6.4
Vigor Switch G2100	V	2.6.4
Vigor Switch PQ2200xb	V	2.6.9
Vigor Switch Q2200x	V	2.6.9
Vigor Switch FX2120	V	2.6.9
Vigor Switch P1282	V	2.6.9
Vigor Switch G1282	V	2.6.9
Vigor Switch PQ2121xb	V	2.8.1
Vigor Switch PQ2121x	V	2.8.1
Vigor Switch Q2121x	V	2.7.1
Vigor Switch G2540xs	V	3.7.0
Vigor Switch P2540xs	V	3.7.0

V-7 Central Management (External Devices)

Vigor router can be used to connect with many types of external devices. In order to control or manage the external devices conveniently, open **External Devices** to make detailed configuration.

Central Management >> External Device

- External Device Syslog
- External Device Auto Discovery
 - Enable Switch Management

External Devices Connected

| Refresh |

Below shows available devices that connected externally:

For security reason:

If you have changed the administrator password on External Device, please click the **Account** button to retype new username and password. Otherwise, the router will be unable to monitor the External Device device properly. Click the **Clear** button to Clear the off-line information and account information.

OK

Available settings are explained as follows:

Item	Description
External Device Syslog	Check this box to display information of the detected device on Syslog.
External Device Auto Discovery	Check this box to detect the external device automatically and display on this page. Enable Switch Management - It is available only if External Device Auto Discovery is enabled. When it is disabled, the switch status and switch profile(s) under Central Management >> Switch will also disabled.

From this web page, check the box of **External Device Auto Discovery** and click **OK**. Later, all the available devices will be displayed in this page with icons and corresponding information. You can change the device name if required or remove the information for off-line device whenever you want.

Central Management >> External Device

- External Device Syslog
- External Device Auto Discovery
 - Enable Switch Management

External Devices Connected

| Refresh |

Below shows available devices that connected externally:

On Line VigorAP810, VigorAP810, Connection Uptime:00:06:04
IP Address:192.168.1.10:80

Account

Clear

When you finished the configuration, click **OK** to save it.



Info

Only DrayTek products can be detected by this function.

Part VI Others



Objects Settings

Define objects such as IP address, service type, keyword, file extension and others. These pre-defined objects can be applied in CSM.



USB

USB device connected on Vigor router can be regarded as a server or WAN interface. By way of Vigor router, clients on LAN can access, write and read data stored in USB storage disk with different applications.

VI-1 Objects Settings

This section allows the creation of objects and object groups from IP addresses, service types, keywords, file extensions, SMS and email recipients, and notification types. Once set up, these objects can be applied to firewall and content management rules.

Web User Interface

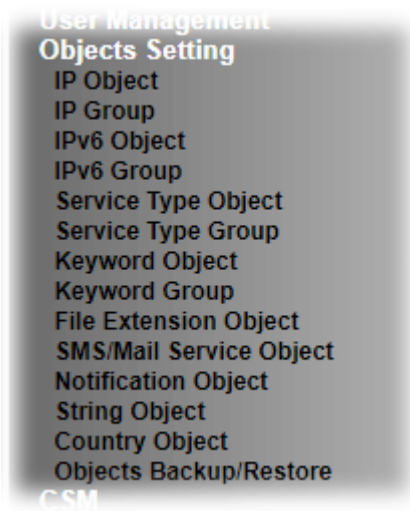

VI-1-1 IP Object

For IPs in a range and service ports in a limited range usually will be applied in configuring router's settings, therefore we can define them with *objects* and bind them with *groups* for using conveniently. Later, we can select that object/group that can apply it. For example, all the IPs in the same department can be defined with an IP object (a range of IP address).

You can set up to **500** sets of IP Objects with different conditions.

[Create from ARP Table](#)
[Create from Routing Table](#)

IP Object Profiles: | [Set to Factory Default](#) |
 View:

Index	Name	Address	Index	Name	Address
1.			17.		
2.			18.		
3.			19.		
4.			20.		
5.			21.		
6.			22.		
7.			23.		
8.			24.		
9.			25.		
10.			26.		
11.			27.		
12.			28.		
13.			29.		
14.			30.		
15.			31.		
16.			32.		

<< [1-32](#) | [33-64](#) | [65-96](#) | [97-128](#) | [129-160](#) | [161-192](#) | [193-224](#) | [225-256](#) | [257-288](#) | [289-320](#) | [321-352](#) | [353-384](#) | [385-416](#) | [417-448](#) | [449-480](#) | [481-500](#) >> [Next](#) >>

[Objects Backup/Restore](#)

Available settings are explained as follows:

Item	Description
View	Use the drop down list to choose a type (Single Address, Range Address, Subnet Address, Mac Address or all) that IP object with the selected type will be shown on this page.
Set to Factory Default	Clear all profiles.
Search	Enter a string of the IP object that you wan to search.
Index	Profile number of the IP object.
Name	Name of the object.
Address	Displays the IP address configured for the object profile.
Objects Backup/Restore	Click it to backup or restore the IP object.

To set up a profile, click the profile number under Index column to bring up the configuration page.

Profile Index : 1

Name:	<input type="text" value="RD Department"/>
Interface:	<input type="text" value="Any"/>
Address Type:	<input type="text" value="Range Address"/>
Mac Address:	<input type="text" value="00 : 00 : 00 : 00 : 00 : 00"/>
Start IP Address:	<input type="text" value="192.168.1.9"/> <input type="button" value="Select"/>
End IP Address:	<input type="text" value="192.168.1.9"/> <input type="button" value="Select"/>
Subnet Mask:	<input type="text" value="255.255.255.254 / 31"/>
Invert Selection:	<input type="checkbox"/>

[Next >>](#)

Available settings are explained as follows:

Item	Description
Name	Name that identifies this profile. Maximum length is 15 characters.
Interface	The network interface on which the IP address or addresses are to be found. Any - All network interfaces. LAN/RT/VPN - All network interfaces except WAN. WAN - Only WAN interfaces.
Address Type	Type of Addresses. Any Address - Object covers all IP addresses. Single Address - Object covers one IP address. Range Address - Object covers a range of IP addresses. Subnet Address - Object covers a range of IP addresses specified in subnet notation. Mac Address - Object contains a MAC address.
MAC Address	Enter MAC address of the network device, if Address Type is Mac Address.
Start IP Address	Enter beginning IP address, if Address Type is one of Single Address, Range Address and Subnet Address.
End IP Address	Enter ending IP address, if Address type is one of Single Address, Range Address and Subnet Address.
Subnet Mask	Enter subnet mask, if Address type is Subnet Mask.
Invert Selection	If selected, all addresses except the ones entered above will be used.

To save changes on the page, click **OK**. To discard changes, click **Cancel**. To blank out all settings in the current IP object, click **Clear**.

[Create from ARP Table](#)

[Create from Routing Table](#)

IP Object Profiles:

View:

Index	Name	Address	Index	Name
1.	RD Department	192.168.1.10 ~ 192.168.1.10	17.	
2.	Financial Dept	Any	18.	
3.	HR Department	211.100.88.0/24	19.	
4.			20.	

VI-1-2 IP Group

Multiple IP Objects can be placed into an IP Group.

Objects Setting >> IP Group

IP Group Table: | [Set to Factory Default](#) |

Index	Name	Index	Name
1.		17.	
2.		18.	
3.		19.	
4.		20.	
5.		21.	
6.		22.	
7.		23.	
8.		24.	
9.		25.	
10.		26.	
11.		27.	
12.		28.	
13.		29.	
14.		30.	
15.		31.	
16.		32.	

[Objects Backup/Restore](#)

Available settings are explained as follows:

Item	Description
Set to Factory Default	Clear all profile settings.
Index	Index number of the profile.
Name	Name that identifies the profile.
Objects Backup/Restore	Click it to backup or restore the IP group object.

To set up a profile, click its index to bring up the configuration page.

Objects Setting >> IP Group

Profile Index : 1

Name:

Interface: ▼

Available IP Objects

>>

<<

Selected IP Objects (Up to 100)

Available settings are explained as follows:

Item	Description
Name	Name that identifies this profile.
Interface	Select WAN, LAN or Any to filter IP objects.
Available IP Objects	All available IP objects that are associated with the selected interface.
Selected IP Objects	IP objects that have been added to this profile.

To add an IP object to the IP Group, select it under Available IP Objects, then click the >> button. To remove an IP object from the IP Group, select it under Selected IP Objects, then click the << button.

To save changes on the page, click OK. To discard changes, click Cancel. To blank out all settings in the current IP group, click Clear.

VI-1-3 IPv6 Object

Up to 200 IPv6 Objects can be created.

Objects Setting >> IPv6 Object

IPv6 Object Profiles:

[Set to Factory Default](#)

Index	Name	Index	Name
1.		17.	
2.		18.	
3.		19.	
4.		20.	
5.		21.	
6.		22.	
7.		23.	
8.		24.	
9.		25.	
10.		26.	
11.		27.	
12.		28.	
13.		29.	
14.		30.	
15.		31.	
16.		32.	

<< [1-32](#) | [33-64](#) | [65-96](#) | [97-128](#) | [129-160](#) | [161-192](#) | [193-200](#) >>

[Next](#) >>

[Objects Backup/Restore](#)

Available settings are explained as follows:

Item	Description
Set to Factory Default	Clear all profile settings.
Index	Index number of the profile.
Name	Name that identifies the profile.
Objects Backup/Restore	Click it to backup or restore the IPv6 object.

To set up a profile, click the profile number under Index column to bring up the configuration page.

Objects Setting >> IPv6 Object

Profile Index : 1

Name:	<input type="text"/>
Address Type:	Range Address ▾
Match Type:	<input checked="" type="radio"/> 128 Bits <input type="radio"/> Suffix 64 Bits(Interface ID)
Mac Address:	<input type="text" value="00 : 00 : 00 : 00 : 00 : 00"/>
Start IP Address:	<input type="text"/> <input type="button" value="Select"/>
End IP Address:	<input type="text"/> <input type="button" value="Select"/>
Prefix Length:	<input type="text"/>
Invert Selection:	<input type="checkbox"/>

[Next >>](#)

Available settings are explained as follows:

Item	Description
Name	Name that identifies this profile. Maximum length is 15 characters.
Address Type	Type of Addresses. Any Address - Object covers all IPv6 addresses. Single Address - Object covers one IPv6 address. Range Address - Object covers a range of IPv6 addresses. Subnet Address - Object covers a range of IPv6 addresses specified in subnet notation. Mac Address - Object contains a MAC address.
Match Type	Specify the match type (128 Bits or Suffix 64 Bits) for the IPv6 address.
Mac Address	Enter MAC address of the network device, if Address Type is Mac Address.
Start IP Address	Enter beginning IP address, if Address Type is one of Single Address, Range Address and Subnet Address.
End IP Address	Enter ending IP address, if Address type is one of Single Address, Range Address and Subnet Address.
Prefix Length	Enter IPv6 prefix length, if Address type is Subnet Address.
Invert Selection	If selected, all addresses except the ones entered above will be used.

To save changes on the page, click **OK**. To discard changes, click **Cancel**. To blank out all settings in the IPv6 object, click **Clear**.

VI-1-4 IPv6 Group

Multiple IPv6 Objects can be placed into an IPv6 Group.

Objects Setting >> IPv6 Group

IPv6 Group Table: | [Set to Factory Default](#) |

Index	Name	Index	Name
1.		17.	
2.		18.	
3.		19.	
4.		20.	
5.		21.	
6.		22.	
7.		23.	
8.		24.	
9.		25.	
10.		26.	
11.		27.	
12.		28.	
13.		29.	
14.		30.	
15.		31.	
16.		32.	

[Objects Backup/Restore](#)

Available settings are explained as follows:

Item	Description
Set to Factory Default	Clear all profile settings.
Index	Index number of the profile.
Name	Name that identifies the profile.
Objects Backup/Restore	Click it to backup or restore the IPv6 group.

To set up a profile, click the profile number under Index column to bring up the configuration page.

Objects Setting >> IPv6 Group

Profile Index : 1

Name:

Available IPv6 Objects

>>

<<

Selected IPv6 Objects (Up to 100)

Available settings are explained as follows:

Item	Description
Name	Name that identifies this profile. Maximum length is 15 characters.
Available IPv6 Objects	All available IP objects that are associated with the selected interface.
Selected IPv6 Objects	IPv6 objects that have been added to this profile.

To add an IPv6 object to the IPv6 Group, select it under Available IPv6 Objects, then click the >> button. To remove an IPv6 object from the IPv6 Group, select it under Selected IPv6 Objects, then click the << button.

To save changes on the page, click OK. To discard changes, click Cancel. To blank out all settings in the current IPv6 group, click Clear.

VI-1-5 Service Type Object

Up to 500 Service Type Objects can be created.

[Objects Setting >> Service Type Object](#)

Service Type Object Profiles: [Set to Factory Default](#)

Index	Name	Index	Name
1.		17.	
2.		18.	
3.		19.	
4.		20.	
5.		21.	
6.		22.	
7.		23.	
8.		24.	
9.		25.	
10.		26.	
11.		27.	
12.		28.	
13.		29.	
14.		30.	
15.		31.	
16.		32.	

<< [1-32](#) | [33-64](#) | [65-96](#) | [97-128](#) | [129-160](#) | [161-192](#) | [193-224](#) | [225-256](#) | [257-288](#) | [289-320](#) | [321-352](#) | [353-384](#) | [385-416](#) | [417-448](#) | [449-480](#) | [481-500](#) >> [Next >>](#)

[Objects Backup/Restore](#)

Available settings are explained as follows:

Item	Description
Set to Factory Default	Clear all profile settings.
Index	Index number of the profile.
Name	Name that identifies the profile.
Objects Backup/Restore	Click it to backup or restore the service type object.

To set up a profile, click the profile number under Index column to bring up the configuration page.

Objects Setting >> Service Type Object Setup

Profile Index : 1

Name	<input type="text" value="www"/>
Protocol	TCP <input type="text" value="6"/>
Source Port	= <input type="text" value="1"/> ~ <input type="text" value="65535"/>
Destination Port	= <input type="text" value="1"/> ~ <input type="text" value="65535"/>

[Next >>](#)

Available settings are explained as follows:

Item	Description
Name	Name that identifies this profile. Maximum length is 15 characters.
Protocol	Protocol(s) to which this profile applies. Any - All protocols. ICMP - Internet Control Message Protocol IGMP - Internet Group Management Protocol TCP - Transmission Control Protocol UDP - User Datagram Protocol TCP/UDP - Transmission Control Protocol and User Datagram Protocol Other - Other protocols not listed above. Enter protocol number in the textbox.
Source/Destination Port	When protocol selected includes TCP or UDP, the source and destination ports can be specified. = - any port that falls within the specified range. != - any port that falls outside of the specified range. - all port numbers that are greater than the specified value. < - all port numbers that are smaller than the specified value.

To save changes on the page, click OK. To discard changes, click Cancel. To blank out all settings in the current service type object, click Clear.

Objects Setting >> Service Type Object

Service Type Object Profiles:

Index	Name	Index
<u>1.</u>	www	<u>17.</u>
<u>2.</u>	SIP	<u>18.</u>
<u>3.</u>		<u>19.</u>
<u>4.</u>		<u>20.</u>

VI-1-6 Service Type Group

Multiple Service Type Objects can be placed into a Service Type Group.

Objects Setting >> Service Type Group

Service Type Group Table:

| [Set to Factory Default](#) |

Group	Name	Group	Name
1.		17.	
2.		18.	
3.		19.	
4.		20.	
5.		21.	
6.		22.	
7.		23.	
8.		24.	
9.		25.	
10.		26.	
11.		27.	
12.		28.	
13.		29.	
14.		30.	
15.		31.	
16.		32.	

[Objects Backup/Restore](#)

Available settings are explained as follows:

Item	Description
Set to Factory Default	Clear all profile settings.
Index	Index number of the profile.
Name	Name that identifies the profile.
Objects Backup/Restore	Click it to backup or restore the service type group object.

To set up a profile, click the profile number under Index column to bring up the configuration page.

Profile Index : 1

Available settings are explained as follows:

Item	Description
Name	Name that identifies this profile.
Available Service Type Objects	All available service type objects.
Selected Service Type Objects	Service type objects that have been added to this profile.

To add a Service Type Object to the Service Type Group, select it under **Available Service Type Objects**, then click the >> button. To remove a Service Type Object to the Service Type Group, select it under **Selected Service Type Objects**, then click the << button.

To save changes on the page, click **OK**. To discard changes, click **Cancel**. To blank out all settings in the current service type group, click **Clear**.

VI-1-7 Keyword Object

200 Keyword Object Profiles can be created for use as blacklists or white lists in CSM >>URL Content Filter Profile and Web Content Filter Profile.

Objects Setting >> Keyword Object

Keyword Object Profiles: | [Set to Factory Default](#) |

Index	Name	Index	Name
1.		17.	
2.		18.	
3.		19.	
4.		20.	
5.		21.	
6.		22.	
7.		23.	
8.		24.	
9.		25.	
10.		26.	
11.		27.	
12.		28.	
13.		29.	
14.		30.	
15.		31.	
16.		32.	

<< [1-32](#) | [33-64](#) | [65-96](#) | [97-128](#) | [129-160](#) | [161-192](#) | [193-200](#) >> [Next](#) >>

[Objects Backup/Restore](#)

Available settings are explained as follows:

Item	Description
Set to Factory Default	Clear all profile settings.
Index	Index number of the profile.
Name	Name that identifies the profile.
Objects Backup/Restore	Click it to backup or restore the keyword object.

To set up a profile, click its index to bring up the configuration page.

Objects Setting >> Keyword Object Setup

Profile Index : 1

Name	<input type="text"/>
Contents	<input type="text"/>

Limit of Contents: Max 3 Words and 63 Characters.
Each word should be separated by a single space.

You can replace a character with %HEX.
Example:
Contents: backdoo%72 virus keep%20out

Result:
1. backdoor
2. virus
3. keep out

Available settings are explained as follows:

Item	Description
Name	Name that identifies this profile. Maximum length is 15 characters.
Contents	Keywords to be matched. Enter the content for this profile. For example, type <i>gambling</i> as Contents. When you browse the webpage, the page with gambling information will be watched out and be passed/blocked based on the configuration on Firewall settings. In addition, up to 3 key phrases, separated by spaces, for a total length of 63 characters can be entered. For key phrases that contain spaces, replace spaces with the sequence %20. For example, the phrase "keep out" is to be entered as "keep%20out".

To save changes on the page, click **OK**. To discard changes, click **Cancel**. To blank out all settings in the current keyword object, click **Clear**.

VI-1-8 Keyword Group

Multiple Keyword Objects can be placed into a Keyword Group.

Keyword groups can be chosen as blacklists or white lists in CSM >>URL /Web Content Filter Profile.

Objects Setting >> Keyword Group

Keyword Group Table: | [Set to Factory Default](#) |

Index	Name	Objects	Index	Name	Objects
1.			17.		
2.			18.		
3.			19.		
4.			20.		
5.			21.		
6.			22.		
7.			23.		
8.			24.		
9.			25.		
10.			26.		
11.			27.		
12.			28.		
13.			29.		
14.			30.		
15.			31.		
16.			32.		

[Objects Backup/Restore](#)

Available settings are explained as follows:

Item	Description
Set to Factory Default	Clear all profile settings.
Index	Index number of the profile.
Name	Name that identifies the profile.
Objects	Display the keyword objects under this group.
Objects Backup/Restore	Click it to backup or restore the keyword group.

To set up a profile, click its index to bring up the configuration page.

Objects Setting >> Keyword Group Setup

Profile Index : 1

Name:

Available Keyword Objects

>>

<<

Selected Keyword Objects (Up to 16)

Available settings are explained as follows:

Item	Description
Name	Name that identifies this profile.
Available Keyword Objects	All keyword objects that have not been added to this profile.
Selected Keyword Objects	Keyword objects that have been added to this profile.

To add a Service Type Object to the Service Type Group, select it under **Available Service Type Objects**, then click the >> button. To remove a Service Type Object to the Service Type Group, select it under **Selected Service Type Objects**, then click the << button.

To save changes on the page, click **OK**. To discard changes, click **Cancel**. To blank out all settings in the current keyword group, click **Clear**.

VI-1-9 File Extension Object

Up to 8 File Extension Objects can be set up for use with CSM>>URL Content Filter.

Objects Setting >> File Extension Object

File Extension Object Profiles: | [Set to Factory Default](#) |

Profile	Name	Profile	Name
<u>1.</u>		<u>5.</u>	
<u>2.</u>		<u>6.</u>	
<u>3.</u>		<u>7.</u>	
<u>4.</u>		<u>8.</u>	

Objects Backup/Restore

Available settings are explained as follows:

Item	Description
Set to Factory Default	Clear all profile settings.
Index	Index number of the profile.
Name	Name that identifies the profile.
Objects Backup/Restore	Click it to backup or restore the file extension object.

To set up a profile, click its index to bring up the configuration page.

Objects Setting >> File Extension Object Setup

Profile Index: 1 Profile Name:

Categories	File Extensions
Image <input type="button" value="Select All"/> <input type="button" value="Clear All"/>	<input type="checkbox"/> .bmp <input type="checkbox"/> .dib <input type="checkbox"/> .gif <input type="checkbox"/> .jpeg <input type="checkbox"/> .jpg <input type="checkbox"/> .jpg2 <input type="checkbox"/> .jp2 <input type="checkbox"/> .pct <input type="checkbox"/> .pcx <input type="checkbox"/> .pic <input type="checkbox"/> .pict <input type="checkbox"/> .png <input type="checkbox"/> .tif <input type="checkbox"/> .tiff <input type="checkbox"/> .ico
Video <input type="button" value="Select All"/> <input type="button" value="Clear All"/>	<input type="checkbox"/> .asf <input type="checkbox"/> .avi <input type="checkbox"/> .mov <input type="checkbox"/> .mpe <input type="checkbox"/> .mpeg <input type="checkbox"/> .mpg <input type="checkbox"/> .mp4 <input type="checkbox"/> .qt <input type="checkbox"/> .rm <input type="checkbox"/> .wmv <input type="checkbox"/> .3gp <input type="checkbox"/> .3gpp <input type="checkbox"/> .3gpp2 <input type="checkbox"/> .3g2 <input type="checkbox"/> .flv <input type="checkbox"/> .swf
Audio <input type="button" value="Select All"/> <input type="button" value="Clear All"/>	<input type="checkbox"/> .aac <input type="checkbox"/> .aiff <input type="checkbox"/> .au <input type="checkbox"/> .mp3 <input type="checkbox"/> .m4a <input type="checkbox"/> .m4p <input type="checkbox"/> .ogg <input type="checkbox"/> .ra <input type="checkbox"/> .ram <input type="checkbox"/> .vox <input type="checkbox"/> .wav <input type="checkbox"/> .wma
Java <input type="button" value="Select All"/> <input type="button" value="Clear All"/>	<input type="checkbox"/> .class <input type="checkbox"/> .jad <input type="checkbox"/> .jar <input type="checkbox"/> .jav <input type="checkbox"/> .java <input type="checkbox"/> .jcm <input type="checkbox"/> .js <input type="checkbox"/> .jse <input type="checkbox"/> .jsp <input type="checkbox"/> .jtk
ActiveX <input type="button" value="Select All"/> <input type="button" value="Clear All"/>	<input type="checkbox"/> .alx <input type="checkbox"/> .apb <input type="checkbox"/> .axs <input type="checkbox"/> .ocx <input type="checkbox"/> .olb <input type="checkbox"/> .ole <input type="checkbox"/> .tlb <input type="checkbox"/> .viv <input type="checkbox"/> .vrm
Compression <input type="button" value="Select All"/> <input type="button" value="Clear All"/>	<input type="checkbox"/> .ace <input type="checkbox"/> .arj <input type="checkbox"/> .bzip2 <input type="checkbox"/> .bz2 <input type="checkbox"/> .cab <input type="checkbox"/> .gz <input type="checkbox"/> .gzip <input type="checkbox"/> .rar <input type="checkbox"/> .sit <input type="checkbox"/> .zip
Execution <input type="button" value="Select All"/> <input type="button" value="Clear All"/>	<input type="checkbox"/> .bas <input type="checkbox"/> .bat <input type="checkbox"/> .com <input type="checkbox"/> .exe <input type="checkbox"/> .inf <input type="checkbox"/> .pif <input type="checkbox"/> .reg <input type="checkbox"/> .scr
P2P <input type="button" value="Select All"/> <input type="button" value="Clear All"/>	<input type="checkbox"/> .torrent
Document <input type="button" value="Select All"/> <input type="button" value="Clear All"/>	<input type="checkbox"/> .doc <input type="checkbox"/> .docx <input type="checkbox"/> .odp <input type="checkbox"/> .ods <input type="checkbox"/> .odt <input type="checkbox"/> .pdf <input type="checkbox"/> .ppt <input type="checkbox"/> .pptx <input type="checkbox"/> .xls <input type="checkbox"/> .xlsx

Available settings are explained as follows:

Item	Description
Profile Name	Name that identifies this profile. Maximum length is 7 characters.
Select All	Selects all file extensions for the category.
Clear All	Deselects all file extensions for the category.

Select the file extensions you wish to be included in the profile. To save changes on the page, click OK. To discard changes, click Cancel. To blank out all settings in the current file extension object, click Clear.

VI-1-10 SMS/Mail Service Object

SMS Service Object

Up to 10 SMS Service Objects can be set up for use with **Application>>SMS Alert Service**.

Objects Setting >> SMS / Mail Service Object

SMS Provider	Mail Server	Set to Factory Default
Index	Profile Name	SMS Provider
1.		
2.		
3.		
4.		
5.		
6.		
7.		
8.		
9.	Custom 1	
10.	Custom 2	

Objects Backup/Restore

Each item is explained as follows:

Item	Description
Set to Factory Default	Clear all profile settings.
Index	Index number of the profile.
Profile	Name that identifies the profile.
SMS Provider	The SMS provider selected for the profile.
Objects Backup/Restore	Click it to backup or restore the service object.

To set up a profile, click the **SMS Provider** tab, and then click its index to bring up the configuration page.

Object Settings >> SMS / Mail Service Object

SMS Provider	Mail Server
Index	Profile Name
1	



Objects Setting >> SMS / Mail Service Object

Profile Index: 1

Profile Name	<input type="text"/>
Service Provider	kotsms.com.tw (TW) ▼
Connection Protocol	<input checked="" type="radio"/> HTTP <input type="radio"/> HTTPS
Username	<input type="text"/> Max: 128 characters
Password	<input type="text"/> Max: 128 characters
SMS Quota	<input type="text"/> 10
Sending Interval	<input type="text"/> 3 (seconds)

Note:

1. Only one message can be sent during the "Sending Interval" time.
2. If the "Sending Interval" was set to 0, there will be no limitation.

Available settings are explained as follows:

Item	Description
Profile Name	Name that identifies this profile. Maximum length is 31 characters.
Service Provider	Select a Service Provider from the dropdown list.
Username	Username used to log in to the service.
Password	Password used to log in to the service.
Quota	Remaining number of text messages allowed to be sent. The quota value reduces by 1 every time the router sends an SMS message. When the quota reaches 0, no SMS will be sent until it is reset to greater than 0.
Sending Interval	Minimum amount of time, in seconds, to wait between sending SMS messages.

To save changes on the page, click **OK**. To discard changes, click **Cancel**. To blank out all settings in the SMS service object, click **Clear**.

Customized SMS Service

The router offers an extensive list of preset SMS service providers for your convenience. However, if your service provider is not among the list of supported service providers, simply use Indexes 9 and 10 to create a customized SMS service profile.

SMS Provider		Mail Server	Set to Factory Default
Index	Profile Name	SMS Provider	
1.			
2.			
3.			
4.			
5.			
6.			
7.			
8.			
9.	Custom 1		
10.	Custom 2		

Objects Backup/Restore

To set up a customized profile, click the SMS Provider tab, and then click one of the 2 indexes (9 and 10) to bring up the configuration page.

Profile Index: 9

Profile Name	<input type="text" value="Custom 1"/>
Service Provider	<input type="text"/>
<div style="border: 1px solid gray; padding: 5px; min-height: 40px;"> Max: 255 characters </div>	
Please contact with your SMS provide to get the exact URL String eg:bulksms.vsms.net:5567/eapi/submission/send_sms/2/2.0?username=###txtUser###&password=###txtPwd###&msisdn=###txtDest###&message=###txtMsg###	
Server Response	<input type="text" value="Max: 31 characters"/>
Username	<input type="text" value="Max: 128 characters"/>
Password	<input type="text" value="Max: 128 characters"/>
Quota	<input type="text" value="10"/>
Sending Interval	<input type="text" value="3"/> (seconds)

Note:

1. Only one message can be sent during the "Sending Interval" time.
2. If the "Sending Interval" was set to 0, there will be no limitation.

Available settings are explained as follows:

Item	Description
Profile Name	Display-only profile name, which is Custom 1 for Index 9 and Custom 2 for Index 10.
Service Provider	Enter an identifier for the service provider. Maximum length is 23 characters.
Entry box	Enter the URL for the SMS service. Maximum length is 255 characters. Contact the service provider for the appropriate URL to use.
Server Response	Enter the API text defined by the SMS provider. It allows Vigor router to acknowledge that the SMS server has received the request coming from the SMS server.

Username	Username used to log in to the service.
Password	Password used to log in to the service.
Quota	Remaining number of text messages allowed to be sent. The quota value reduces by 1 every time the router sends an SMS message. When the quota reaches 0, no SMS will be sent until it is reset to greater than 0.
Sending Interval	Minimum amount of time, in seconds, to wait between sending SMS messages.

To save changes on the page, click **OK**. To discard changes, click **Cancel**. To blank out all settings in the SMS service object, click **Clear**.

Mail Service Object

Up to 10 Mail Service Objects can be set up for use with **Application>>SMS/Mail Alert Service**.

Objects Setting >> SMS / Mail Service Object

SMS Provider		Mail Server	Set to Factory Default
Index	Profile Name		
1.			
2.			
3.			
4.			
5.			
6.			
7.			
8.			
9.			
10.			

Objects Backup/Restore

Each item is explained as follows:

Item	Description
Set to Factory Default	Clear all profile settings.
Index	Index number of the profile.
Profile	Name that identifies the profile.
Objects Backup/Restore	Click it to backup or restore the service object.

To set up a profile, click the Mail Server tab, and then click its index to bring up the configuration page.

Profile Index: 1

Profile Name	<input type="text" value="Mail_Notify"/>
Interface	<input type="text" value="Any"/>
SMTP Server	<input type="text" value="192.168.1.98"/>
SMTP Port	<input type="text" value="587"/>
Sender Address	<input type="text" value="carrie_n@draytek.com"/>
Connection Security	<input type="text" value="StartTLS"/> <input checked="" type="radio"/> Accept using plain text if StartTLS connection failed. <input type="radio"/> Force StartTLS. Stop if StartTLS connection failed.
<input checked="" type="checkbox"/> Authentication	
Username	<input type="text" value="john"/>
Password	<input type="password" value="*****"/>
Sending Interval	<input type="text" value="0"/> (seconds)

Note:

1. Only one mail can be sent during the "Sending Interval" time.
2. If the "Sending Interval" was set to 0, there will be no limitation.

Available settings are explained as follows:

Item	Description
Profile Name	Name that identifies this profile.
Interface	Specify the WAN interface for a mail passing through.
SMTP Server	IP address of the SMTP server.
SMTP Port	Port number of the SMTP server.
Sender Address	E-mail address of the sender.
Connection Security	<p>There are three methods to enhance the connection security of SMTP server.</p> <p>Plaintext - No SSL. Packets will be transferred without encryption.</p> <p>SSL - Packets will be transferred with encrypted connection. Select to use SMTPS (SMTP over SSL) to communicate with the SMTP server. Note that the port number used for SMTPS server is 465.</p> <p>StartTLS - Specify one of the two modes. The packets will be transferred or stopped transmission according to the practical situation that occurred.</p> <ul style="list-style-type: none"> ● "Accept using plain text if StartTLS connection failed" - If selected, the connection security will be done by StartTLS server. However, if the connection failed, then the packets will be transferred without encryption instead. ● "Force StartTLS. Stop if StartTLS connection failed" - If selected, the connection security will be done by StartTLS server. However, if the StartTLS connection failed, the packets will not be transferred.
Authentication	Select to send username and password to SMTP server for authentication.

	<p>Username - Username for authentication. Maximum length is 31 characters.</p> <p>Password - Password for authentication. Maximum length is 31 characters.</p>
Sending Interval	Minimum amount of time, in seconds, to wait between sending e-mail messages.
Send a Test E-mail	Click it to send a test e-mail according to above configuration.

To save changes on the page, click **OK**. To discard changes, click **Cancel**. To blank out all settings in the mail service object, click **Clear**.

VI-1-11 Notification Object

Up to 8 Notification Objects can be set up for use in Application>>SMS Alert Service and Application>>Mail Alert Service.

You can set an object with different monitoring situation.

[Objects Setting >> Notification Object](#)

Index	Profile Name	Settings
1.		
2.		
3.		
4.		
5.		
6.		
7.		
8.		

[| Set to Factory Default |](#)

[Objects Backup/Restore](#)

To set up a profile, click its index to bring up the configuration page.

Profile Index: 1

Profile Name		<input type="text"/>
Category	Status	
WAN	<input type="checkbox"/> Disconnected	<input type="checkbox"/> Reconnected
	<input type="checkbox"/> Disconnected	<input type="checkbox"/> Reconnected
VPN Tunnel	<input type="checkbox"/> Downtime Limit	
	<input type="text" value="60~3600"/> seconds	
Temperature Alert	<input type="checkbox"/> USB Out of Range	
WAN Budget	<input type="checkbox"/> Limit Reached	
High Availability	<input type="checkbox"/> Failover Occurred	
	<input type="checkbox"/> Config Sync Fail	
	<input type="checkbox"/> Router Unstable	
Security	<input type="checkbox"/> Web Log-in	
	<input type="checkbox"/> Telnet Log-in	
	<input type="checkbox"/> SSH Log-in	
	<input type="checkbox"/> TR069 Log-in	
	<input type="checkbox"/> FTP User Log-in	
	<input type="checkbox"/> Config Changed(From WebUI and CLI)	

Note:

1. When High Availability is enabled, "Sending Interval" of **SMS Provider profile** should set to 0.
2. When the VPN Downtime limit is enabled, Vigor Router will not send the VPN Down alert immediately. It will send the Alert after the Downtime limit period if the VPN still doesn't go up.

Available settings are explained as follows:

Item	Description
Profile Name	Name that identifies this profile.
Category	Areas to be monitored.
Status	Select the states to be monitored.

To save changes on the page, click OK. To discard changes, click Cancel. To blank out all settings in the notification object, click Clear.

VI-1-12 String Object

This page allows you to set string profiles which will be applied in route policy (domain name selection for destination) and etc.

Objects Setting >> String Object

10 strings per page | [Set to Factory Default](#) | [Clear](#)

Index	String	
1		<input type="checkbox"/>
2	portal.draytek.com	<input type="checkbox"/>
3		<input type="checkbox"/>
4		<input type="checkbox"/>
5		<input type="checkbox"/>
6		<input type="checkbox"/>
7		<input type="checkbox"/>
8		<input type="checkbox"/>

[Add](#)

Available settings are explained as follows:

Item	Description
Add	Click it to open the following page for adding a new string object. <div style="border: 1px solid gray; padding: 5px; width: fit-content;"> <p>String</p> <p>Max: 253 characters</p> <p style="text-align: right;">OK Cancel</p> </div>
Set to Factory Default	Click it to clear all of the settings in this page.
Index	Display the number link of the string profile.
String	Display the string defined.
Clear	Choose the string that you want to remove. Then click this check box to delete the selected string.

Below shows an example to apply string object (in Route Policy):

Routing >> Load-Balance/Route Policy

Index: 1

Enable

Comment [Delete](#)

Criteria

Protocol

Source

Start: End:

Destination

[Select](#) [Delete](#)

[Add](#)

Destination Port

VI-1-13 Country Object

The country object profile can determine which country/countries shall be blocked by the Vigor router's Firewall.

Objects Setting >> Country Object

Country Object Table: [Set to Factory Default](#)

Index	Name	Index	Name
1.		17.	
2.		18.	
3.		19.	
4.		20.	
5.		21.	
6.		22.	
7.		23.	
8.		24.	
9.		25.	
10.		26.	
11.		27.	
12.		28.	
13.		29.	
14.		30.	
15.		31.	
16.		32.	

[Objects Backup/Restore](#)

The country object, by grouping IP addresses for multiple countries, can be applied by other functions such as router policy destination (refer to the following figure for example).

Routing >> Load-Balance/Route Policy

Index: 1

Enable

Comment

Criteria

Protocol ▾

Source ▾

Start: End:

Destination ▾

▾

Destination Port ▾

Send via if Criteria Matched ▾

To set a new profile, please do the steps listed below:

1. Open **Object Setting>>Country Object**, and click the number (e.g., #1) under Index column for configuration in details.

- The configuration page will be shown as follows:

Objects Setting >> Country Object

Profile Index : 1

Name:

<p>Available Country</p> <div style="border: 1px solid gray; padding: 2px;"> 1-Afghanistan 2-Aland Islands 3-Albania 4-Algeria 5-American Samoa 6-Andorra 7-Angola 8-Anguilla 9-Antarctica </div>	<input type="button" value=">>"/> <input type="button" value="<<"/>	<p>Selected Country (Up to 16)</p> <div style="border: 1px solid gray; height: 80px;"></div>
--	--	---

Next >>

Note:

The maximum number of Selected Country is 16!

Available settings are explained as follows:

Item	Description
Name	Type a name for such profile.
Available Country / Selected Country	Select any country from Available Country. Click >> to move the selected country and place on Selected Country. Note that one country profile can contain 1 up to 16 countries.

- After finishing all the settings here, please click OK to save the configuration.

Objects Setting >> Country Object

Country Object Table:

| [Set to Factory Default](#) |

Index	Name	Index	Name
1.	Taiwan	17.	
2.		18.	
3.		19.	
4.		20.	
5.		21.	
6.		22.	
7.		23.	
8.		24.	

VI-1-14 Objects Backup/Restore

The objects settings can be backup as a file. The backup file can be imported to the device to restore the configuration in the future if required.

Objects Setting >> Objects Backup/Restore

Backup

Select All

IP Object

IP Group

IPv6 Object

IPv6 Group

Service Type Object

Service Type Group

Keyword Object

Keyword Group

File Extension Object

SMS/Mail Service Object

Notification Object

String Object

Country Object

Backup the current IP Objects with a CSV file

Download the default CSV template to edit

Restore

未選擇任何檔案

Note:

For better compatibility, it's suggested to edit IP Objects with the provided default CSV template.

Available settings are explained as follows:

Item	Description
Backup	<p>Usually, the IP objects can be created one by one through the web page of Objects>>IP Object. However, to a user who wants to save more time in bulk creating IP objects, a quick method is offered by Vigor router to modify the IP objects with a single file, a CSV file.</p> <p>All of the IP objects (or the template) can be exported as a file by clicking Download. Then the user can open the CSV file through Microsoft Excel and modify all the IP objects at the same time.</p> <p>Backup the current IP Objects with a CSV file - Click it to backup current IP objects as a CSV file. Such file can be restored for future use.</p> <p>Download the default CSV template to edit - After clicking it, press Download to store the default CSM template (a table without any input data) to your hard disk.</p> <p>Download - Download the CSV file from Vigor router and store in your hard disk.</p>
Restore	<p>Select - Click it to specify a predefined CSV file.</p> <p>Restore - Import the selected CSV file onto Vigor router.</p>

Application Notes

A-1 How to Send a Notification to Specified Phone Number via SMS Service in WAN Disconnection

Follow the steps listed below:

1. Log into the web user interface of Vigor router.
2. Configure relational objects first. Open Object Settings>>SMS/Mail Server Object to get the following page.

Objects Setting >> SMS / Mail Service Object

SMS Provider	Mail Server	Set to Factory Default
Index	Profile Name	SMS Provider
1.		
2.		
3.		
4.		
5.		
6.		
7.		
8.		
9.	Custom 1	
10.	Custom 2	

Index 1 to Index 8 allows you to choose the built-in SMS service provider. If the SMS service provider is not on the list, you can configure Index 9 and Index 10 to add the new service provider to Vigor router.

3. Choose any index number (e.g., Index 1 in this case) to configure the SMS Provider setting. In the following page, type the username and password and set the quota that the router can send the message out.

Objects Setting >> SMS / Mail Service Object

Profile Index: 1

Profile Name	<input type="text" value="Local number"/>
Service Provider	<input type="text" value="kotsms.com.tw (TW)"/>
Username	<input type="text" value="abc5026"/>
Password	<input type="password" value="*****"/>
Quota	<input type="text" value="10"/>
Sending Interval	<input type="text" value="3"/> (seconds)

Note:

1. Only one message can be sent during the "Sending Interval" time.
2. If the "Sending Interval" was set to 0, there will be no limitation.

- After finished the settings, click **OK** to return to previous page. Now you have finished the configuration of the SMS Provider profile setting.

Objects Setting >> SMS / Mail Service Object

SMS Provider		Mail Server	Set to Factory Default
Index	Profile Name	SMS Provider	
1.	Local number	kotsms.com.tw (TW)	
2.			
3.			
4.			
5.			
6.			
7.			
8.			
9.	Custom 1		
10.	Custom 2		

- Open Object Settings>>Notification Object to configure the event conditions of the notification.

Object Settings >> Notification Object

			Set to Factory Default
Index	Profile Name	Settings	
1.			
2.			
3.			
4.			
5.			
6.			
7.			
8.			

- Choose any index number (e.g., Index 1 in this case) to configure conditions for sending the SMS. In the following page, type the name of the profile and check the Disconnected and Reconnected boxes for WAN to work in concert with the topic of this paper.

Objects Setting >> Notification Object

Profile Index: 1

Profile Name		WAN_Notify	
Category	Status		
WAN	<input checked="" type="checkbox"/> Disconnected	<input checked="" type="checkbox"/> Reconnected	
VPN Tunnel	<input type="checkbox"/> Disconnected	<input type="checkbox"/> Reconnected	

- After finished the settings, click **OK** to return to previous page. You have finished the configuration of the notification object profile setting.

Object Settings >> Notification Object

Set to Factory Default		
Index	Profile Name	Settings
1.	WAN_Notify	WAN
2.		
3.		
4.		
5.		
6.		
7.		
8.		

- Now, open **Application >> SMS / Mail Alert Service**. Use the drop down list to choose SMS Provider and the Notify Profile (specify the time of sending SMS). Then, type the phone number in the field of Recipient (the one who will receive the SMS).

Applications >> SMS / Mail Alert Service

SMS Alert		Mail Alert		Set to Factory Default	
Index	Enable	SMS Provider	Recipient Number	Notify Profile	Schedule(1-15)
1	<input checked="" type="checkbox"/>	1 - Local number	0910222366	1 - WAN_Notify	None None
2	<input type="checkbox"/>	1 - Local number		1 - WAN_Notify	None None
3	<input type="checkbox"/>	1 - Local number		1 - WAN_Notify	None None
4	<input type="checkbox"/>	1 - Local number		1 - WAN_Notify	None None
5	<input type="checkbox"/>	1 - Local number		1 - WAN_Notify	None None
6	<input type="checkbox"/>	1 - Local number		1 - WAN_Notify	None None
7	<input type="checkbox"/>	1 - Local number		1 - WAN_Notify	None None
8	<input type="checkbox"/>	1 - Local number		1 - WAN_Notify	None None
9	<input type="checkbox"/>	1 - Local number		1 - WAN_Notify	None None
10	<input type="checkbox"/>	1 - Local number		1 - WAN_Notify	None None

- Click **OK** to save the settings. Later, if one of the WAN connections fails in your router, the system will send out SMS to the phone number specified. If the router has only one WAN interface, the system will send out SMS to the phone number while reconnecting the WAN interface successfully.

Remark: How the customize the SMS Provider

Choose one of the Index numbers (9 or 10) allowing you to customize the SMS Provider. In the web page, type the URL string of the SMS provider and type the username and password. After clicking OK, the new added SMS provider will be added and will be available for you to specify for sending SMS out.

Objects Setting >> SMS / Mail Service Object

Profile Index: 9

Profile Name	<input type="text" value="Custom 1"/>
Service Provider	<input type="text" value="clickatell"/>
Max: 255 characters	
<div style="border: 1px solid black; height: 40px;"></div>	
Please contact with your SMS provide to get the exact URL String eg:bulksms.vsms.net:5567/eapi/submission/send_sms/2/2.0?username=###txtUser### &password=###txtPwd###&msisdn=###txtDest###&message=###txtMsg###	
Username	<input type="text" value="test333"/>
Password	<input type="password" value="....."/>
Quota	<input type="text" value="10"/>
Sending Interval	<input type="text" value="3"/> (seconds)

Note:

1. Only one message can be sent during the "Sending Interval" time.
2. If the "Sending Interval" was set to 0, there will be no limitation.

VI-2 USB Application

USB devices connected to the Vigor router can function as storage servers, WAN interfaces, network printers or thermometers.

After setting the configuration in USB Application, a USB storage device can be accessed using either the FTP or SMB protocol from LAN clients with the IP address of the Vigor router and the username and password entered in **USB Application>>USB User Management**.



Info

USB modems that are supported by the router are listed in **USB Application>>Modem Support List**. For network connection via USB modem, refer to **WAN>>Internet Access** and **WAN>>General Setup** for detailed information.

Web User Interface

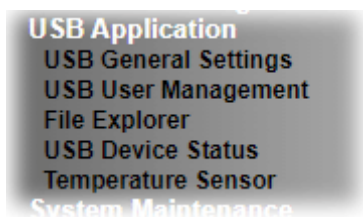

VI-2-1 USB General Settings

This page allows you to configure the file sharing feature of the Vigor router, where USB mass storage devices such as thumb drives and hard drives can be made accessible to LAN clients. Currently, only FAT16 and FAT32 file systems are supported by the Vigor router, so verify that the USB drive contains these file systems. FAT32 is recommended because of its long filename support, which FAT16 lacks.

USB Application >> USB General Settings

USB General Settings

General Settings	
Simultaneous FTP Connections	<input type="text" value="5"/> (Maximum 6)
Default Charset	<input type="text" value="English"/> ▼

Note:

1. If character set is set to "English", only English long file name is supported.
2. Multi-session FTP download will be banned by Router FTP server. If your FTP client has a multi-connection mechanism, such as FileZilla, you should limit client connections to 1 to improve performance.

OK

Available settings are explained as follows:

Item	Description
Simultaneous FTP Connections	Enter the maximum number of simultaneous FTP sessions allowed. The router allows up to 6 simultaneous sessions.
Default Charset	Select the character set for file and directory names. Currently, the Vigor router supports four character sets. The default charset is English.

Select OK to save changes on the page.

VI-2-2 USB User Management

This page allows you to set up profiles for FTP/SMB users. Any user who wants to access the USB storage disk must authenticate using a username and password that have been configured on this page. Please connect a USB storage device before adding or modifying settings on this page, or else an error message will appear requesting you to do so before allowing you to proceed.

USB User Management [Set to Factory Default](#)

Index	Enable	Username	Home Folder	File Access Rule	Directory Access Rule
1.	<input type="checkbox"/>				
2.	<input type="checkbox"/>				
3.	<input type="checkbox"/>				
4.	<input type="checkbox"/>				
5.	<input type="checkbox"/>				
6.	<input type="checkbox"/>				
7.	<input type="checkbox"/>				
8.	<input type="checkbox"/>				
9.	<input type="checkbox"/>				
10.	<input type="checkbox"/>				
11.	<input type="checkbox"/>				
12.	<input type="checkbox"/>				
13.	<input type="checkbox"/>				
14.	<input type="checkbox"/>				
15.	<input type="checkbox"/>				

Click index number to access into configuration page.

Profile Index: 1

Enable

Username

Password

Confirm Password

Home Folder

Access Rule

File Read Write Delete

Directory List Create Remove

Note:
 The folder name can only contain the following characters: A-Z a-z 0-9 \$ % ' - _ @ ~ ` ! () and space.

Available settings are explained as follows:

Item	Description
Enable	Check to activate this profile (account) for FTP service and / or SMB service. Later, the user can use the username specified in this page to login into FTP server.
Username	Enter the username for this user profile. Maximum allowed length of the username is 11 characters. Note: Anonymous user access is not supported. Note: "Admin" cannot be used as a username, as it is reserved for access to web pages on the Vigor router, and for FTP firmware upgrade.

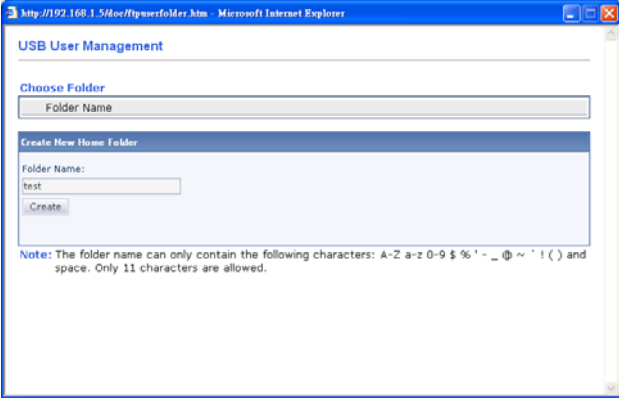
	Note: Ensure that the FTP client does not use passive FTP mode as it is not supported by the Vigor router.
Password	Enter the password for this user profile. Maximum allowed length of the username is 11 characters.
Confirm Password	Enter the password again to confirm.
Home Folder	<p>Enter the folder which will be the root folder for FTP and SMB sessions established using the credentials of this user profile. Only folders and files inside this selected root folder are accessible to the user. In addition, if the user types "/" here, the user can access into all of the disk folders and files in USB storage disk.</p> <p>To browse the list of folders available for selection, or to create a new folder, click the  icon.</p>  <p>Note: If the USB storage device is write-protected, new folders cannot be created. Only existing folders can be selected.</p> <p>Note: Only folders directly under the root can be selected as the home folder.</p>
Access Rule	<p>It determines the authority for such profile. Any user, who uses such profile for accessing into USB storage disk, must follow the rule specified here.</p> <p>File - Check the items (Read, Write and Delete) for such profile.</p> <p>Directory -Check the items (List, Create and Remove) for such profile.</p>

To save changes on this page, ensure that a USB storage device is connected, and click OK. To discard changes, click Cancel. To blank out all settings in the current IP object, click Clear.

VI-2-3 File Explorer

File Explorer offers an easy way for users to view and manage the content of USB storage disk connected on Vigor router.

USB Application >> File Explorer



USB Disk Connection Status: Disk Connected

| Refresh |

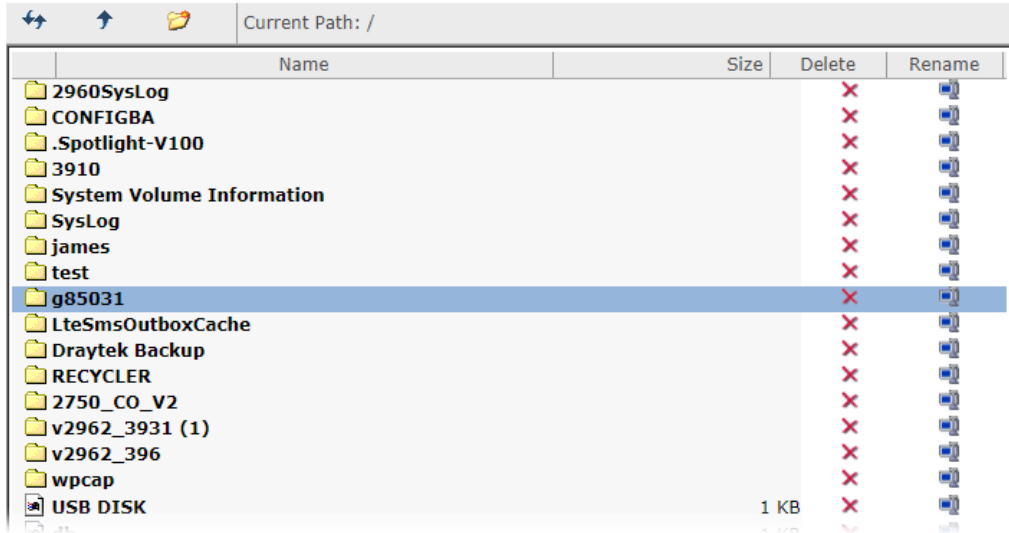
File Explorer



Available settings are explained as follows:

Item	Description
 Refresh	Click this icon to refresh the list of files and folders.
 Back	Click this icon to return to the parent folder.
 Create	Click this icon to add a new folder.
Current Path	Shows current folder.
Upload	To upload a file to the USB storage device, click the Browse... button to bring up the file selection dialog box. Select the file you wish to upload, and click the Upload button to initiate the upload process.

VI-2-4 USB Device Status

This page allows monitoring of the status of USB devices (disk and sensor) connected to the Vigor router.

USB Application >> USB Device Status

Disk
Sensor
| [Refresh](#) |

USB Mass Storage Device Status

Connection Status: No Disk Connected Disconnect USB Disk

Disk Capacity: 0 MB

Free Capacity: 0 MB [Refresh](#)

USB Disk Users Connected

Index	Service	IP Address(Port)	Username

Note:

1. Only support FAT16 and FAT32 format, FAT32 is recommended.
2. Only support to mount single partition, maximum capacity is 500GB. If there are more than one partition, only one of them will be mounted.
3. Single file size can be up to 4GB, which is the limitation of FAT32 format.
4. If the write protect switch of USB disk is turned on, the USB disk is in **READ-ONLY** mode. No data can be written to it.

To maintain the data integrity of a USB disk that is connected to the router, always click **Disconnect USB Disk** before unplugging the disk from the router.

USB Mass Storage Device Status

Connection Status: Disk Connected Disconnect USB Disk

Write Protect Status: No

Disk Capacity: 29567 MB

Free Capacity: 22625 MB [Refresh](#)

USB Disk Users Connected

Index	Service	IP Address(Port)	Username

Note:

1. Only support FAT16 and FAT32 format, FAT32 is recommended.
2. Only support to mount single partition, maximum capacity is 500GB. If there are more than one partition, only one of them will be mounted.
3. Single file size can be up to 4GB, which is the limitation of FAT32 format.
4. If the write protect switch of USB disk is turned on, the USB disk is in **READ-ONLY** mode. No data can be written to it.

Available settings are explained as follows:

Item	Description
Connection Status	Shows whether a USB disk is connected or not. If there is no USB device connected to the Vigor router, "No Disk Connected" will be displayed.
Disk Capacity	Shows the total capacity of the USB storage disk.
Free Capacity	Shows the free space on the USB storage disk. Click Refresh at any time to get the most up-to-date free capacity.
USB Disk Users Connected	Shows the clients that are connected to the SMB/FTP server. Index - The profile index used by the LAN client to establish the connection. Service - Shows whether the connection is using FTP or SMB.

	<p>IP Address - Shows the client's IP address.</p> <p>Username - Shows the username used to establish the connection.</p>
Disconnect USB Disk	<p>Before unplugging the USB storage device from the router, make sure you click this first to ensure that all data has been written to the disk and all open files are closed.</p>

After a USB storage device has been connected, the **Connection Status** will be updated within a few seconds.

USB Mass Storage Device Status

Connection Status: Disk Connected Disconnect USB Disk

Write Protect Status: No

Disk Capacity: 29567 MB

Free Capacity: 22625 MB [Refresh](#)

USB Disk Users Connected

Index	Service	IP Address(Port)	Username

Note:

1. Only support FAT16 and FAT32 format, FAT32 is recommended.
2. Only support to mount single partition, maximum capacity is 500GB. If there are more than one partition, only one of them will be mounted.
3. Single file size can be up to 4GB, which is the limitation of FAT32 format.
4. If the write protect switch of USB disk is turned on, the USB disk is in **READ-ONLY** mode. No data can be written to it.

VI-2-5 Temperature Sensor

A USB Thermometer is now available. It complements your installed DrayTek router installations which will help you monitor the server or data communications room environment and notify you if the server room or data communications room is overheating.



During summer in particular, it is important to ensure that your server or data communications equipment are not overheating due to cooling system failures.

The inclusion of a USB thermometer in compatible Vigor routers will continuously monitor the temperature of its environment. When a pre-determined threshold is reached you will be alerted by either an email or SMS so you can undertake appropriate action.

For a list of supported USB thermometers, visit our website at <https://www.draytek.com/en/products/usb-thermometer/> or contact your local DrayTek partner.

Temperature Sensor Settings

USB Application >> Temperature Sensor Setting

Temperature Chart	Temperature Sensor Settings
Display Settings	
Temperature Calibration	<input type="text" value="0.00"/>
Temperature Unit	<input checked="" type="radio"/> Celsius <input type="radio"/> Fahrenheit
Alarm Settings	
<input type="checkbox"/> Enable Syslog Alarm	
Upper temperature limit	<input type="text" value="30.00"/>
Lower temperature limit	<input type="text" value="18.00"/>

Note:

Set 1) Notification Object, 2) SMS / Mail Service Object, 3) SMS / Mail Alert Service to make Vigor router send alert when the temperature reaches the limit.

Available settings are explained as follows:

Item	Description
Display Settings	<p>Temperature Calibration - Enter the difference between the actual temperature and the temperature as reported by the thermometer.</p> <p>Temperature Unit - Select the temperature scale to be used.</p>
Alarm Settings	<p>Enable Syslog Alarm - Select to enable recording of the temperature in Syslog.</p> <p>Upper temperature limit/Lower temperature limit - Enter the upper and lower temperature limits. If the temperature falls outside of this range, an alert will be sent.</p>

Temperature Chart

Below shows an example of temperature graph:

USB Application >> Temperature Sensor Graph

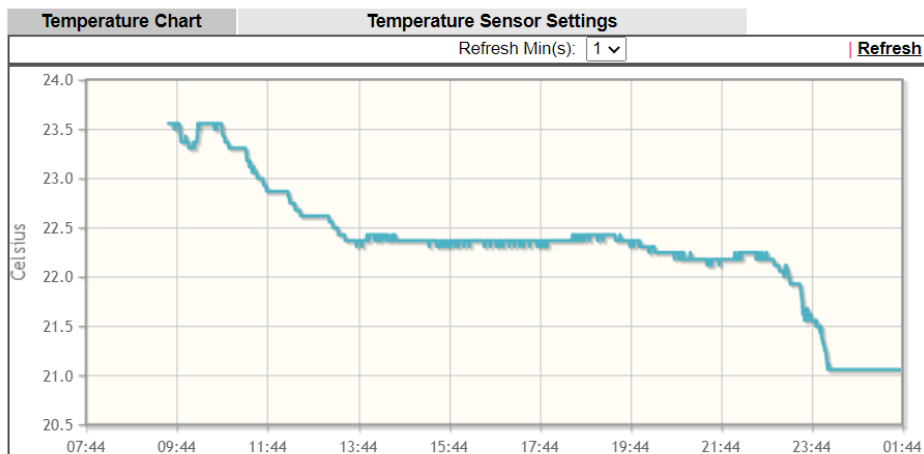

Manufacturer: RDing
 Product: TEMPer1F_V3.4
 Current Temperature: 21.06
 Average Temperature: 22.33
 Maximum Temperature: 23.56
 Minimum Temperature: 21.06

Part VII Troubleshooting



Troubleshooting

This part will guide you to solve abnormal situations if you cannot access into the Internet after installing the router and finishing the web configuration.

VII-1 Diagnostics

This section will guide you to solve abnormal situations if you cannot access into the Internet after installing the router and finishing the web configuration. Please follow sections below to check your basic installation status stage by stage.

- Checking if the hardware status is OK or not.
- Checking if the network connection settings on your computer are OK or not.
- Pinging the router from your computer.
- Checking if the ISP settings are OK or not.
- Backing to factory default setting if necessary.

If all above stages are done and the router still cannot run normally, it is the time for you to contact your dealer or DrayTek technical support for advanced help.

Web User Interface

This section contains utilities that can assist you in analyzing issues and failures during the setup and operation of the router.

Diagnostics

- Dial-out Triggering
- Routing Table
- ARP Cache Table
- IPv6 Neighbour Table
- DHCP Table
- NAT Sessions Table
- DNS Cache Table
- Ping Diagnosis
- Data Flow Monitor
- Port Mirror/Packet Capture
- Traffic Graph
- VPN Graph
- Trace Route
- Syslog Explorer
- IPv6 TSPC Status
- High Availability Status
- Authentication Information
- DoS Flood Table
- Route Policy Diagnosis
- Debug Logs

VII-1-1 Dial-out Triggering

This page shows the packet header that is transmitted when a WAN connection (such as a PPPoE connection) is initiated.

Diagnostics >> Dial-out Triggering

Dial-out Triggered Packet Header

| [Refresh](#) |

HEX Format:

```
00 1D AA 4B 3E 80-30 65 EC 82 C6 5F-08 00
45 00 00 34 AA F5 40 00-7F 06 59 6B C0 A8 64 0A
C0 A8 12 08 D5 03 0B B8-88 12 F6 6C 00 00 00 00
80 02 FA F0 1D 81 00 00-02 04 05 B4 01 03 03 08
01 01 04 02 AA 4D 30 7D-95 4D 00 00 00 00 00 06
AA 4D 80 B2 25 46 00 00-00 00 B8 BE 11 40 00 00
```

Decoded Format:

```
192.168.100.10,54531 -> 192.168.18.8,3000
Pr TCP HLen 20 TLen 52 -S Seq 1828065928 Ack 0 Win 64240
```

Available settings are explained as follows:

Item	Description
Decoded Format	Shows the dial-out triggered packet header in hexadecimal format.

Refresh	Shows the dial-out triggered packet header in human-readable format.
---------	--

VII-1-2 Routing Table

Click Diagnostics and click Routing Table to open the web page.

Diagnostics >> View Routing Table

IPv4

Key	Destination	Gateway	Interface
S~	192.168.10.0/ 255.255.255.0	via 192.168.1.2	LAN1
C~	192.168.1.0/ 255.255.255.0	directly connected	LAN1
S~	211.100.88.0/ 255.255.255.0	via 192.168.1.3	LAN1

Key

C: Connected S: Static R: RIP *: default ~: private B: BGP O: OSPF

Note:

1. IPv4 Routing Table Limit 511 entries.
2. If you want to show all entries, please use telnet "ip route status" command.

IPv6

Destination	Interface	Flags	Metric	Next Hop
FE80::/64	LAN1	U	256	::
FE80::/64	LAN2	U	256	::
FE80::/64	LAN3	U	256	::
FE80::/64	LAN4	U	256	::
FE80::/64	LAN5	U	256	::
FE80::/64	LAN6	U	256	::
FE80::/64	LAN7	U	256	::
FE80::/64	LAN8	U	256	::
FE80::/64	LAN9	U	256	::
FE80::/64	LAN10	U	256	::
FE80::/64	LAN11	U	256	::
FE80::/64	LAN12	U	256	::
FE80::/64	LAN13	U	256	::
FE80::/64	LAN14	U	256	::

Show Detail

Available settings are explained as follows:

Item	Description
Refresh	Click it to reload the page.

VII-1-3 ARP Cache Table

Click **Diagnostics** and click **ARP Cache Table** to view the content of the ARP (Address Resolution Protocol) cache held in the router. The table shows a mapping between an Ethernet hardware address (MAC Address) and an IP address.

Diagnostics >> View ARP Cache Table

LAN		WAN			
Show:	<input type="text" value="ALL LANs"/>	and	<input type="text" value="ALL VLANs"/>		
Ethernet ARP Cache Table Clear Refresh 					
IP Address	MAC Address	HOST ID	Interface	VLAN	Port
192.168.1.9	60-A4-4C-E6-5A-4F		LAN1	---	P5

Show Comment

Available settings are explained as follows:

Item	Description
Show	Select the LAN(s) and VLAN(s) to display ARP table information. By default, information on all LANs and VLANs is displayed.
Refresh	Click it to reload the page with the most up-to-date information.

VII-1-4 IPv6 Neighbour Table

This page displays the mapping between Ethernet hardware addresses (MAC addresses) and IPv6 addresses. This information is helpful in diagnosing network problems, such as IP address conflicts.

Click **Diagnostics** and click **IPv6 Neighbour Table** to open the web page.

[Diagnostics >> View IPv6 Neighbour Table](#)

IPv6 Neighbour Table			Refresh
IPv6 Address	Mac Address	Interface	
FF02::2	33-33-00-00-00-02	LAN	
FF02::1:3	33-33-00-01-00-03	LAN	
FE80::3D5E:E74:8751:A44B	e8-9d-87-87-69-2f	LAN	
FF02::1:FF51:A44B	33-33-ff-51-a4-4b	LAN	
FE80::250:7FFF:FEC9:1E79	00-50-7f-c9-1e-79	LAN	
FE80::250:7FFF:FEC8:4305	00-50-7f-c8-43-05	LAN	
FF02::1	33-33-00-00-00-01	LAN	
FF02::1	00-00-00-00-00-00	USB2	
FF02::1:2	00-00-00-00-00-00	USB2	
FE80::9D5C:CA86:5428:3CA7	00-26-2d-fe-63-4f	LAN	
FF02::1:FF0A:673C	33-33-ff-0a-67-3c	LAN	

Available settings are explained as follows:

Item	Description
Refresh	Click it to reload the page with the most up-to-date information.

VII-1-5 DHCP Table

This page provides information on IP address assignments. This information is helpful in diagnosing network problems, such as IP address conflicts, etc.

Click **Diagnostics** and click **DHCP Table** to open the web page.

Diagnostics >> View DHCP Assigned IP Addresses

Show : ALL LANs ▼

DHCP IP Assignment Table		Other IP Assignment Table			Refresh
Index	IP Address	MAC Address	Leased Time	HOST ID	

LAN1 : DHCP Server On IP Pool: 192.168.1.10 ~ 192.168.1.209					

Index	IP Address	MAC Address	Leased Time	HOST ID	

LAN1					
1	192.168.1.10	14-49-8C-42-6E-1E	20:30:31		
2	192.168.1.11	00-1D-AA-0C-CD-08	21:09:25		

Show Comment

DHCPv6 IP Assignment Table					Refresh
Index	IPv6 Address	IAID	Link-layer Address	Leased Time	

Available settings are explained as follows:

Item	Description
Index	Shows the index of the DHCP entry.
IP Address	Shows the IP address assigned by the router to the MAC address.
MAC Address	Shows the MAC address of this DHCP entry.
Leased Time	Shows the remaining time of the DHCP lease of the device.
HOST ID	Shows the host ID of this network device.
Refresh	Click to reload this page with the most up-to-date information.

VII-1-6 NAT Sessions Table

Click **Diagnostics** and click **NAT Sessions Table** to open the list page.

Diagnostics >> NAT Sessions Table

NAT Active Sessions Table (Limit: 1000 entries)

Proto	Private IP : Port	Pseudo#Port	Peer IP : Port	Interface
1	TCP 192.168.13.99 :22668	#52313	108.177.125.188 : 5228	WAN3

Found 1 entries. Page : / 1. Sort by :

Filter :

Protocol : Interface : WAN

Address : Netmask : Port :

Available settings are explained as follows:

Item	Description
Private IP:	Shows the IP address of the LAN host.
Port #	Shows the port number used on the LAN host for this NAT session.
Pseudo Port	Shows the external port number used on the WAN interface for this NAT session.
Peer IP:	Shows the remote host's IP address.
Port	Shows the port number used on the remote host for this NAT session.
Interface	Shows the WAN interface used for this NAT session.
Filter	Shows the sessions table according to the specified conditions.
Refresh	Click to reload this page with the most up-to-date information.

VII-1-7 DNS Cache Table

The router can function as a DNS server which allows LAN clients to look up DNS information by sending DNS requests to the router. Such DNS information is temporarily cached on the router and can be viewed on this page.

Click **Diagnostics** and click **DNS Cache Table** to open the web page.

Diagnostics >> DNS Cache Table

IPv4 DNS Cache Table

| [Clear](#) | [Refresh](#) |

Domain Name	IP Address	TTL(s)
ms.draytek.com	192.168.18.8	79510

IPv6 DNS Cache Table

| [Clear](#) | [Refresh](#) |

Domain Name	IP Address	TTL(s)
-------------	------------	--------

Note:

The LAN DNS entry's TTL is static.

When an entry's TTL is larger than s, this entry will be deleted from the table.

OK

Available settings are explained as follows:

Item	Description
Clear	Click to clear all cached DNS lookup entries.
Refresh	Click it to reload the page.
When an entry's TTL is larger than....	When this box is checked, DNS entries whose TTL (time to live, in seconds) exceeds the valued specified here will be deleted from the router's cache automatically. Be sure to click OK after making changes to have them saved.

VII-1-8 Ping Diagnosis

Click Diagnostics and click Ping Diagnosis to open the web page.

Diagnostics >> Ping Diagnosis

Ping Diagnosis

IPV4 IPV6
 Ping through: Source IP:
 Ping to: IP Address:

Result | [Clear](#) |

Note:

1. If you want to ping a LAN PC or you don't want to specify which WAN to ping through, please select "Auto" in Ping Through.
2. If you select "Auto" in Source IP, we will fill Source IP according to the interface you ping through.

or

Diagnostics >> Ping Diagnosis

Ping Diagnosis

IPV4 IPV6
 Ping through: Ping IPv6 Address:

Result | [Clear](#) |

Note:

1. If you want to ping a LAN PC or you don't want to specify which WAN to ping through, please select "Auto" in Ping Through.
2. If you select "Auto" in Source IP, we will fill Source IP according to the interface you ping through.

Available settings are explained as follows:

Item	Description
IPV4 / IPV6	Choose the interface for such function. Select the protocol to perform the ping operation.
Ping through	Select a WAN interface from drop down list to through which you want to perform the ping operation, or choose Auto to

	be let the router select the WAN interface.
Ping to	Select the type of target to which you wish to ping.
IP Address	Enter the IP address of the Host/IP that you want to ping.
Ping IPv6 Address	Enter the IPv6 address that you want to ping.
Run	Click this button to initiate the ping process. The result will be displayed on the screen.
Clear	Click this link to clear the ping result.

VII-1-9 Data Flow Monitor

This page displays the uplink and downlink rates, and number of sessions of each LAN client. The information is refreshed at an interval specified by the user. Before using the Data Flow Monitor, LAN clients that are to be monitored need to have their IP addresses configured in Bandwidth Management, and Bandwidth and Session Limits must be specified. Otherwise, a dialog box will appear reminding you to do so.

Bandwidth Management >> Sessions Limit

IPv4	IPv6	
<input checked="" type="radio"/> Enable <input type="radio"/> Disable		
Default Max Sessions: <input type="text" value="100"/>		
Limitation List (Max. 20 entries)		
Index	Start IP	End IP

Click **Diagnostics** and click **Data Flow Monitor** to load the web page. You can click **IP Address**, **TX rate**, **RX rate** or **Session** links in the header to sort the displayed data.

Diagnostics >> Data Flow Monitor

Enable Data Flow Monitor

Refresh Seconds: Page:

| [Refresh](#) |

Index	IP Address	TX Rate(Kbps)	RX Rate(Kbps) ▾	Sessions	Action	APP QoS
		Current / Peak / Speed	Current / Peak / Speed	Current / Peak		
WAN1	---	0 / 0 / Auto	0 / 0 / Auto	0		
WAN3	111.251.194.93	18 / 3861 / Auto	4 / 265 / Auto	0		
WAN5	---	0 / 0 / Auto	0 / 0 / Auto	0		
WAN6	---	0 / 0 / Auto	0 / 0 / Auto	0		
WAN7	---	0 / 0 / Auto	0 / 0 / Auto	0		
WAN8	---	0 / 0 / Auto	0 / 0 / Auto	0		
Total		18 / 3861 / Auto	4 / 265 / Auto	0 / 0		

Note:

1. Click "Block" to prevent specified PC from surfing Internet for 5 minutes.
2. The IP blocked by the router will be shown in red, and the session column will display the remaining time that the specified IP will be blocked.
3. (Kbps): shared bandwidth
+ : residual bandwidth used
Current/Peak are average.

Available settings are explained as follows:

Item	Description
Enable Data Flow Monitor	Check this box to enable this function.
Refresh Seconds	Select the desired refresh time interval from the drop-down

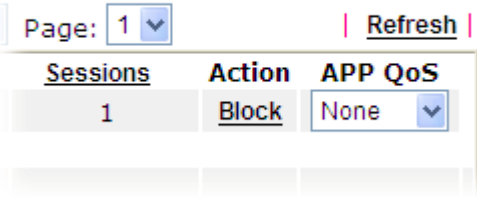
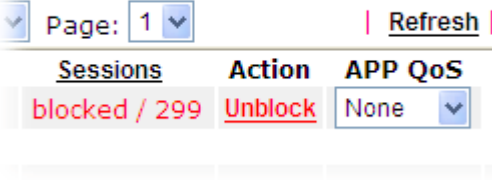
	list. The page will then be refreshed with updated information at the selected interval.
Refresh	Click to refresh this page manually.
Index	Shows the index of the data flow.
IP Address	Shows the IP address of the monitored device.
TX rate (kbps)	Shows the transmission speed of the monitored device.
RX rate (kbps)	Shows the receiving speed of the monitored device.
Sessions	Shows the number of session that you specified on the Limit Session web page.
Action	<p>Block - can prevent specified PC accessing into Internet within 5 minutes.</p>  <p>Unblock -The device with the IP address will be blocked for five minutes. The remaining time will be shown on the session column. Click it to cancel the IP address blocking.</p> 
APP QoS	Use the drop down list to change the priority in data transmission for the specified IP address (host).
Current /Peak/Speed	<p>Current means current transmission rate and receiving rate for WAN interface.</p> <p>Peak means the highest peak value detected by the router in data transmission.</p> <p>Speed means line speed specified in WAN>>General Setup. If you do not specify any rate at that page, here will display Auto for instead.</p>

VII-1-10 Port Statistics

Diagnostics >> Port Statistics

Physical Port Statistics				System Uptime: 1day 4:53:53
Port	TX Packets	TX Bytes	RX Packets	RX Bytes
1	0	0	0	0
2	0	0	0	0
3	0	0	0	0
4	0	0	0	0
5	0	0	0	0
6	0	0	0	0
7	0	0	0	0
8	0	0	0	0
9	67,604	36.18 MB	86,690	10.88 MB
10	9,210	1.49 MB	0	0
11	9,210	1.49 MB	0	0
12	9,210	1.49 MB	0	0

VII-1-11 Port Mirror/Packet Capture

The Port Mirror function allows network traffic of select LAN ports to be forwarded to another LAN port for analysis. This is useful for enforcing policies, detecting unauthorized access, monitoring network performance, etc.

If selecting "Continuously Send All Packets to Mirror Port", the setting page will be shown as follows:

Diagnostics >> Port Mirror/Packet Capture

- Continuously Send All Packets to Mirror Port
 Download .pcap

Enable Disable

	P1	P2	P3	P4	P5	P6	P7	P8	P9	P10	P11	P12
	WAN1	LAN	WAN3	LAN	WAN5	WAN6	WAN7	WAN8	LAN	LAN	LAN	LAN
Mirror Port		<input type="radio"/>		<input type="radio"/>					<input type="radio"/>	<input type="radio"/>	<input type="radio"/>	<input checked="" type="radio"/>
Mirrored Tx Port	<input type="checkbox"/>	<input type="checkbox"/>	<input type="checkbox"/>	<input type="checkbox"/>	<input type="checkbox"/>	<input type="checkbox"/>	<input type="checkbox"/>	<input type="checkbox"/>	<input type="checkbox"/>	<input type="checkbox"/>	<input type="checkbox"/>	<input type="checkbox"/>
Mirrored Rx Port	<input type="checkbox"/>	<input type="checkbox"/>	<input type="checkbox"/>	<input type="checkbox"/>	<input type="checkbox"/>	<input type="checkbox"/>	<input type="checkbox"/>	<input type="checkbox"/>	<input type="checkbox"/>	<input type="checkbox"/>	<input type="checkbox"/>	<input type="checkbox"/>
Mirrored VPN	<input type="checkbox"/> All <input type="checkbox"/> LAN to LAN profile <input type="text" value="None"/> <input type="button" value="v"/> <input type="checkbox"/> Remote Dial-in User <input type="text" value="None"/> <input type="button" value="v"/>											

OK

Available settings are explained as follows:

Item	Description
Continuously Send All Packets to Mirror Port	Select to send all packets to mirror port.
Enable/Disable	Select Enable to activate the function. Select Disable to cancel the function.
Mirror Port	One and only one port is selected as the mirror port, to

	which traffic is to be forwarded.
Mirrored Tx Port	Port(s) whose outbound traffic will be forwarded to the mirror port.
Mirrored Rx Port	Port(s) whose inbound traffic will be forwarded to the mirror port.
Mirrored VPN	<p>VPN(s) that the incoming and outgoing packets will be forwarded to the mirror VPN.</p> <p>All - The packets within all VPN tunnels will be forwarded to the mirror port selected above.</p> <p>LAN to LAN - The packets within the selected LAN to LAN VPN tunnel will be forwarded to the mirror port selected above.</p> <p>Remote Dial-in User - The packets passing through the specified remote dial-in account will be forwarded to the mirror port selected above.</p>
OK	Save the settings.

If selecting "Download .pcap", the setting page will be shown as follows:

Diagnostics >> Port Mirror/Packet Capture

- Continuously Send All Packets to Mirror Port
 Download .pcap

	P1 WAN1	P2 LAN	P3 WAN3	P4 LAN	P5 WAN5	P6 WAN6	P7 WAN7	P8 WAN8	P9 LAN	P10 LAN	P11 LAN	P12 LAN
Mirror Port	<input checked="" type="radio"/>	<input type="radio"/>	<input type="radio"/>	<input type="radio"/>	<input type="radio"/>	<input type="radio"/>	<input type="radio"/>	<input type="radio"/>	<input type="radio"/>	<input type="radio"/>	<input type="radio"/>	<input type="radio"/>
Mirrored Tx Port	<input type="checkbox"/>	<input type="checkbox"/>	<input type="checkbox"/>	<input type="checkbox"/>	<input type="checkbox"/>	<input type="checkbox"/>	<input type="checkbox"/>	<input type="checkbox"/>	<input type="checkbox"/>	<input type="checkbox"/>	<input type="checkbox"/>	<input type="checkbox"/>
Mirrored Rx Port	<input type="checkbox"/>	<input type="checkbox"/>	<input type="checkbox"/>	<input type="checkbox"/>	<input type="checkbox"/>	<input type="checkbox"/>	<input type="checkbox"/>	<input type="checkbox"/>	<input type="checkbox"/>	<input type="checkbox"/>	<input type="checkbox"/>	<input type="checkbox"/>
Mirrored VPN	<input type="checkbox"/> All <input type="checkbox"/> LAN to LAN profile <input type="text" value="None"/> <input type="button" value="v"/> <input type="checkbox"/> Remote Dial-in User <input type="text" value="None"/> <input type="button" value="v"/>											

Status: IDLE

Setting Capture All Packets Capture with Filter

Duration (seconds)

Available settings are explained as follows:

Item	Description
Download .pcap	Packets coming from the mirrored Tx/Rx Port(s), mirrored VPN can be captured and downloaded periodically (duration).
Mirrored Tx Port	Port(s) whose outbound traffic will be forwarded to the mirror port.
Mirrored Rx Port	Port(s) whose inbound traffic will be forwarded to the mirror port.
Mirrored VPN	<p>VPN(s) that the incoming and outgoing packets will be forwarded to the mirror VPN.</p> <p>All - Capture the packets within all VPN tunnels.</p> <p>LAN to LAN - Capture the packets within the selected LAN to</p>

	<p>LAN VPN tunnels.</p> <p>Remote Dial-in User - Capture the VPN packets within the specified remote dial-in account.</p>												
Setting	<p>Capture All Packets - All packets will be captured for analysis.</p> <p>Capture with Filter - Only the packets filtered by ICMP, TCP, UDP, or TCP/UDP will be captured for analysis.</p>												
Duration	Set a period of time for Vigor router to capture the packets.												
Filter Settings	<p>It is available only when Capture with Filter is selected.</p> <p>Protocol - Filter the packet by using Any, ICMP, TCP, UDP, and TCP/UDP.</p> <p>IP Address - Filter the packet by IP address. If Customized IP is selected, please enter an IP address in the entry box.</p> <p>Port - It is available when TCP, UDP, or TCP/UDP is selected as the Protocol. Select Any or Customize Port. If Customize Port is selected, please enter a port number in the entry box.</p>												
Start	<p>Click to begin the packet capturing.</p> <p>Diagnostics >> Port Mirror/Packet Capture</p> <hr/> <p> <input type="radio"/> Continuously Send All Packets to Mirror Port <input checked="" type="radio"/> Download .pcap </p> <table border="1"> <thead> <tr> <th></th> <th>P1 WAN1</th> <th>P2 WAN2</th> </tr> </thead> <tbody> <tr> <td>Mirror Port</td> <td></td> <td></td> </tr> <tr> <td>Mirrored Tx Port</td> <td><input checked="" type="checkbox"/></td> <td><input checked="" type="checkbox"/></td> </tr> <tr> <td>Mirrored Rx Port</td> <td><input checked="" type="checkbox"/></td> <td><input checked="" type="checkbox"/></td> </tr> </tbody> </table> <p>Status: Capturing </p> <p>Setting <input checked="" type="radio"/> Capture All Packets <input type="radio"/> Capture with Filter</p> <p>Duration <input type="text" value="60"/> (seconds)</p> <p style="text-align: right;"> <input type="button" value="Start"/> <input type="button" value="Stop"/> <input type="button" value="Downl"/> </p>		P1 WAN1	P2 WAN2	Mirror Port			Mirrored Tx Port	<input checked="" type="checkbox"/>	<input checked="" type="checkbox"/>	Mirrored Rx Port	<input checked="" type="checkbox"/>	<input checked="" type="checkbox"/>
	P1 WAN1	P2 WAN2											
Mirror Port													
Mirrored Tx Port	<input checked="" type="checkbox"/>	<input checked="" type="checkbox"/>											
Mirrored Rx Port	<input checked="" type="checkbox"/>	<input checked="" type="checkbox"/>											
Stop	Click to terminate the scanning job.												
Download	Click to download the packet capture result as a file with the file format, .pcap.												

After finishing all the settings here, please click OK to save the configuration.

VII-1-12 Traffic Graph

Click **Diagnostics** and click **Traffic Graph** to open the web page. Choose WAN1/WAN3/WAN5/WAN6/WAN7/WAN8 Bandwidth, Sessions, daily or weekly for viewing different traffic graph. Click **Reset** to zero the accumulated RX/TX (received and transmitted) data of WAN. Click **Refresh** to renew the graph at any time.

Diagnostics >> Traffic Graph



The horizontal axis represents time. Yet the vertical axis has different meanings. For WAN1/WAN3/WAN5/WAN6/WAN7/WAN8 Bandwidth chart, the numbers displayed on vertical axis represent the numbers of the transmitted and received packets in the past.

For Sessions chart, the numbers displayed on vertical axis represent the numbers of the NAT sessions during the past.

VII-1-13 VPN Graph

Click **Diagnostics** and click **VPN Graph** to open the web page.

VPN Log Details

Select **VPN Log Details** to view textual records about VPN connections.

Diagnostics >> VPN Graph

VPN Log Details	VPN Graph	VPN Traffic Graph
Host to LAN ▾ 1. JimmyLinux ▾		
2023-11-29 18:40:29	[WireGuard] [H2L] [LOCAL] [Index: 50]	[Name: JimmyLinux] [From 10.3.5.103] [UP]
2023-11-29 19:40:30	[WireGuard] [H2L] [LOCAL] [Index: 50]	[Name: JimmyLinux] [From 10.3.5.103] [DOWN]
2023-11-29 19:42:37	[WireGuard] [H2L] [LOCAL] [Index: 50]	[Name: JimmyLinux] [From 10.3.5.103] [UP]
2023-11-29 20:42:39	[WireGuard] [H2L] [LOCAL] [Index: 50]	[Name: JimmyLinux] [From 10.3.5.103] [DOWN]
2023-11-29 20:44:44	[WireGuard] [H2L] [LOCAL] [Index: 50]	[Name: JimmyLinux] [From 10.3.5.103] [UP]
2023-11-29 21:44:45	[WireGuard] [H2L] [LOCAL] [Index: 50]	[Name: JimmyLinux] [From 10.3.5.103] [DOWN]
2023-11-29 21:46:51	[WireGuard] [H2L] [LOCAL] [Index: 50]	[Name: JimmyLinux] [From 10.3.5.103] [UP]
2023-11-29 22:46:53	[WireGuard] [H2L] [LOCAL] [Index: 50]	[Name: JimmyLinux] [From 10.3.5.103] [DOWN]
2023-11-29 22:49:58	[WireGuard] [H2L] [LOCAL] [Index: 50]	[Name: JimmyLinux] [From 10.3.5.103] [UP]
2023-11-29 23:50:00	[WireGuard] [H2L] [LOCAL] [Index: 50]	[Name: JimmyLinux] [From 10.3.5.103] [DOWN]
2023-11-29 23:52:06	[WireGuard] [H2L] [LOCAL] [Index: 50]	[Name: JimmyLinux] [From 10.3.5.103] [UP]
2023-11-30 00:52:08	[WireGuard] [H2L] [LOCAL] [Index: 50]	[Name: JimmyLinux] [From 10.3.5.103] [DOWN]
2023-11-30 00:54:13	[WireGuard] [H2L] [LOCAL] [Index: 50]	[Name: JimmyLinux] [From 10.3.5.103] [UP]
2023-11-30 01:54:14	[WireGuard] [H2L] [LOCAL] [Index: 50]	[Name: JimmyLinux] [From 10.3.5.103] [DOWN]
2023-11-30 01:56:20	[WireGuard] [H2L] [LOCAL] [Index: 50]	[Name: JimmyLinux] [From 10.3.5.103] [UP]
2023-11-30 02:56:22	[WireGuard] [H2L] [LOCAL] [Index: 50]	[Name: JimmyLinux] [From 10.3.5.103] [DOWN]
2023-11-30 02:58:28	[WireGuard] [H2L] [LOCAL] [Index: 50]	[Name: JimmyLinux] [From 10.3.5.103] [UP]
2023-11-30 03:58:30	[WireGuard] [H2L] [LOCAL] [Index: 50]	[Name: JimmyLinux] [From 10.3.5.103] [DOWN]
2023-11-30 04:00:35	[WireGuard] [H2L] [LOCAL] [Index: 50]	[Name: JimmyLinux] [From 10.3.5.103] [UP]
2023-11-30 05:00:37	[WireGuard] [H2L] [LOCAL] [Index: 50]	[Name: JimmyLinux] [From 10.3.5.103] [DOWN]
2023-11-30 05:02:42	[WireGuard] [H2L] [LOCAL] [Index: 50]	[Name: JimmyLinux] [From 10.3.5.103] [UP]
2023-11-30 06:02:44	[WireGuard] [H2L] [LOCAL] [Index: 50]	[Name: JimmyLinux] [From 10.3.5.103] [DOWN]
2023-11-30 06:04:50	[WireGuard] [H2L] [LOCAL] [Index: 50]	[Name: JimmyLinux] [From 10.3.5.103] [UP]
2023-11-30 07:04:52	[WireGuard] [H2L] [LOCAL] [Index: 50]	[Name: JimmyLinux] [From 10.3.5.103] [DOWN]
2023-11-30 07:06:57	[WireGuard] [H2L] [LOCAL] [Index: 50]	[Name: JimmyLinux] [From 10.3.5.103] [UP]
2023-11-30 08:06:58	[WireGuard] [H2L] [LOCAL] [Index: 50]	[Name: JimmyLinux] [From 10.3.5.103] [DOWN]
2023-11-30 08:09:04	[WireGuard] [H2L] [LOCAL] [Index: 50]	[Name: JimmyLinux] [From 10.3.5.103] [UP]
2023-11-30 08:22:15	[WireGuard] [H2L] [LOCAL] [Index: 50]	[Name: JimmyLinux] [From 10.3.5.103] [DOWN]
2023-11-30 08:23:08	[WireGuard] [H2L] [LOCAL] [Index: 50]	[Name: JimmyLinux] [From 10.3.5.103] [UP]
2023-11-30 09:23:10	[WireGuard] [H2L] [LOCAL] [Index: 50]	[Name: JimmyLinux] [From 10.3.5.103] [DOWN]

Available settings are explained as follows:

Item	Description
Host to LAN/LAN to LAN	Select Host to LAN to view log entries on VPN connections that were initiated by VPN teleworkers. Select LAN to LAN to view log entries on LAN-to-LAN VPN connections to or from this router.
Index	Select a VPN connection to view its log entries.

VPN Graph

Select VPN Graph to visualize the VPN connections through graphic representations.

Exampe 1,

Diagnostics >> VPN Graph

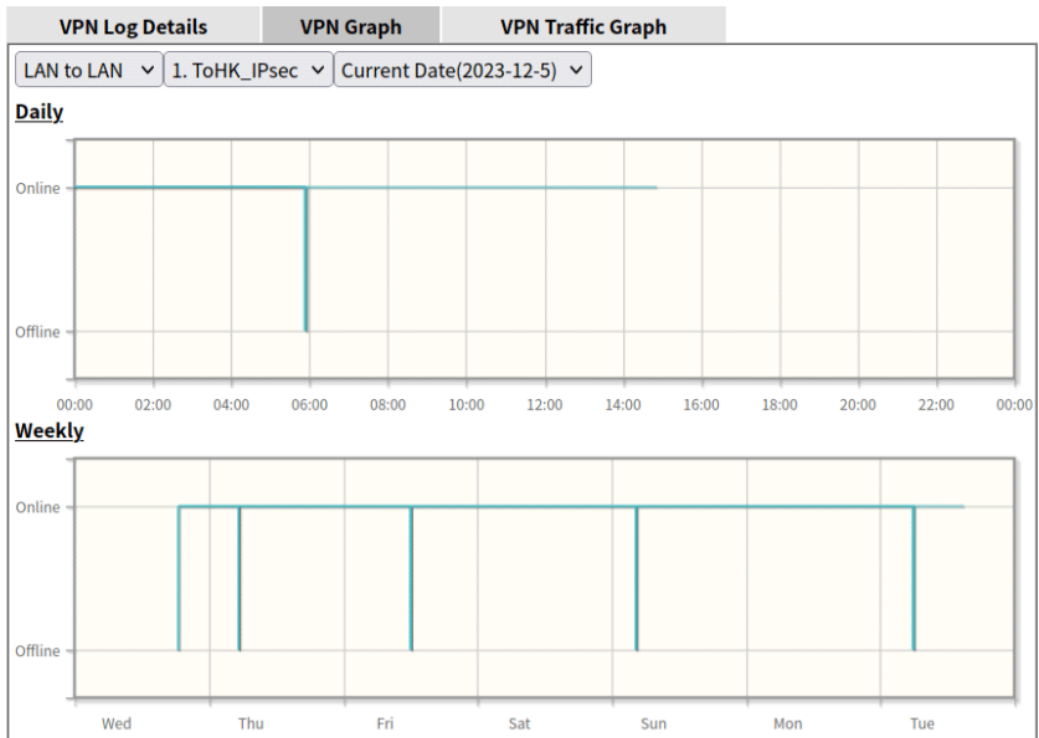

Example 2,

Diagnostics >> VPN Graph

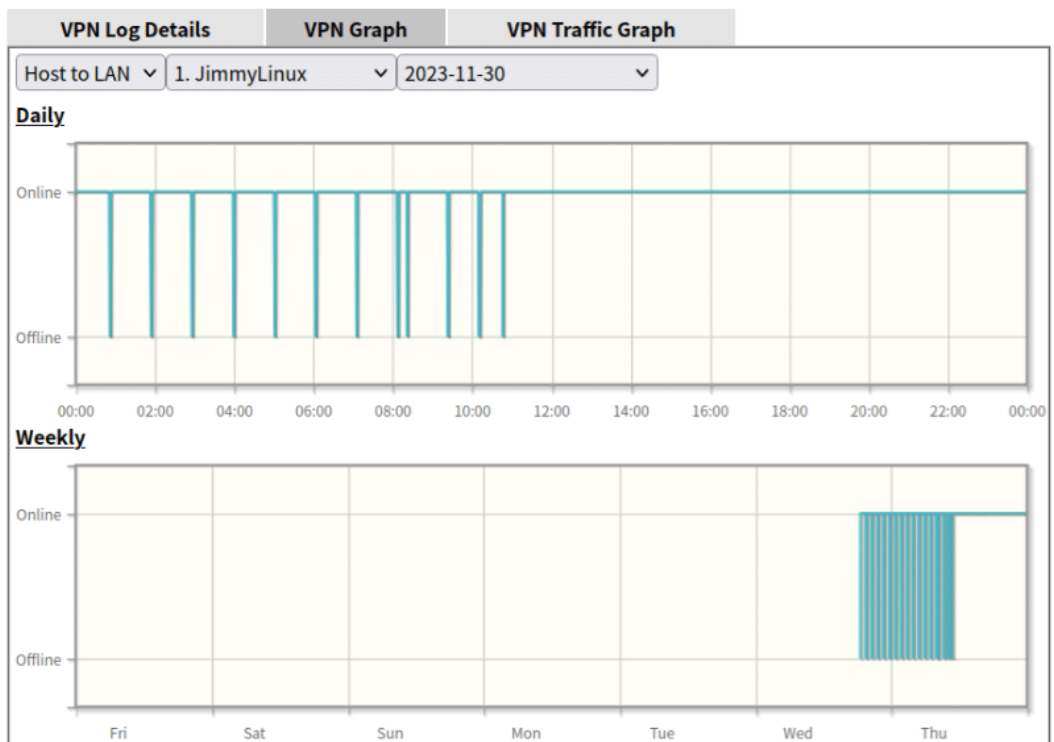

Available settings are explained as follows:

Item	Description
Host to LAN/LAN to LAN	Select Host to LAN to view log entries on VPN connections that were initiated by VPN teleworkers. Select LAN to LAN to view log entries on LAN-to-LAN VPN connections to or from this router.
Index	Select a VPN connection to view its log entries.
Date	Select the date for which you wish to view traffic statistics. The traffic information for this date will be shown in the daily graph, and the traffic information for the week before this date will be shown in the weekly graph.

VPN Traffic Graph

Select this tab to observe a graphical representation of VPN traffic over time.

Click **Reset** to zero the accumulated RX/TX (received and transmitted) data of WAN. Click **Refresh** to renew the graph at any time.

Diagnostics >> VPN Graph

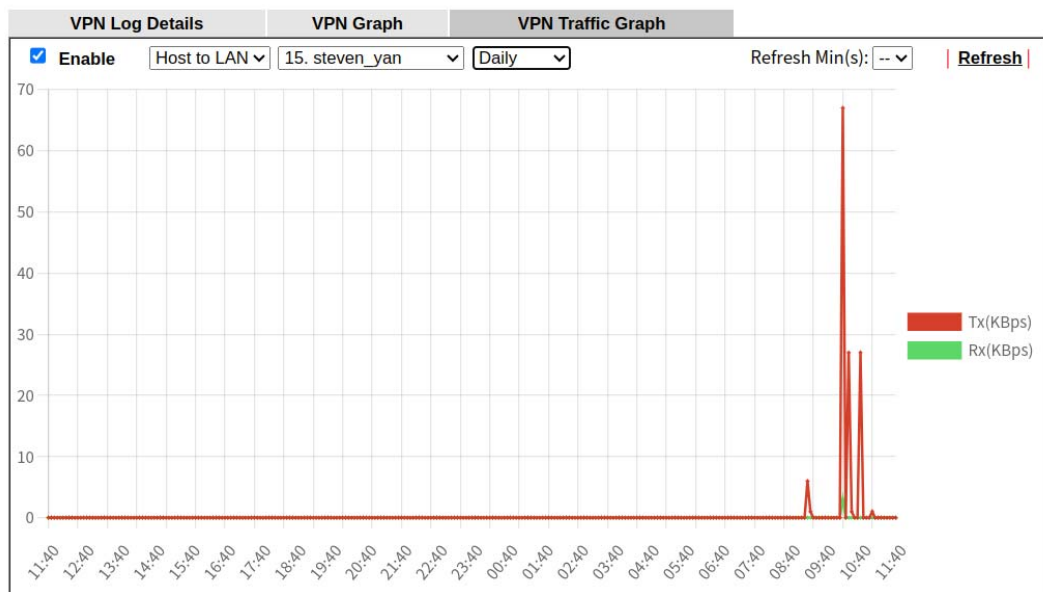

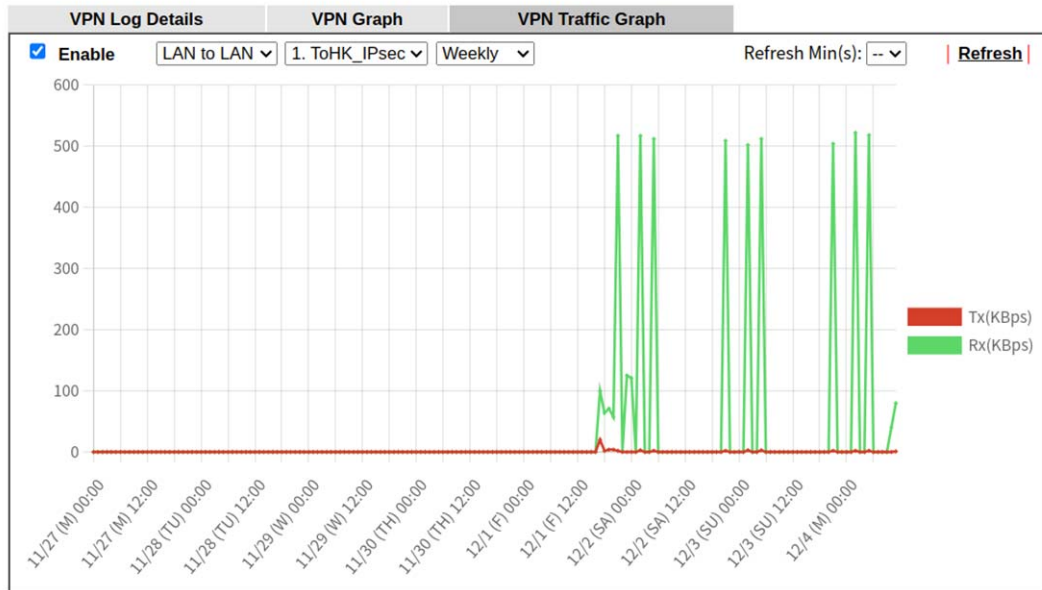

The horizontal axis represents time. Yet the vertical axis has different meanings. For WAN1/WAN3/WAN5/WAN6/WAN7/WAN8 Bandwidth chart, the numbers displayed on vertical axis represent the numbers of the transmitted and received packets in the past.

For Sessions chart, the numbers displayed on vertical axis represent the numbers of the NAT sessions during the past.

VII-1-14 Trace Route

Click **Diagnostics** and click **Trace Route** to open the web page. This page allows you to trace the routes from router to the host. Simply Enter the IP address of the host in the box and click **Run**. The result of route trace will be shown on the screen.

[Diagnostics >> Trace Route](#)

Trace Route

IPV4 IPV6

Trace through:

Protocol:

Host / IP Address:

Result [Clear](#)

or

[Diagnostics >> Trace Route](#)

Trace Route

IPV4 IPV6

Trace Host / IP Address:

Result [Clear](#)

Available settings are explained as follows:

Item	Description
IPv4 / IPv6	Select the IP version used to perform the trace route.
Trace through	Select the WAN interface used to perform the trace route.
Protocol	Select either UDP or ICMP used to perform the trace route.
Host/IP Address	Enter the hostname or the IP address of trace route destination.

Trace Host/IP Address	Enter the hostname or the IPv6 address of trace route destination.
Run	Click this button to start the trace.
Clear	Click to clear the trace route result.

VII-1-15 Syslog Explorer

This page displays syslog information in real time. There are two options for displaying syslog information: Web Syslog and USB Syslog.

This page displays User/Firewall/call/WAN/VPN Syslog events and their time of occurrence. To enable Web Syslog, check the **Enable Web Syslog** checkbox, specify the type of Syslog events to view, and select the display mode. The log messages will start appearing as events matching the selected type occur.

Diagnostics >> Syslog Explorer

Web Syslog
USB Syslog

Enable Web Syslog
 Syslog Type User
Display Mode Always record the new event
[Export](#) | [Refresh](#) | [Clear](#)

Time	Message
2021-01-04 03:50:13	Local User (MAC=30-65-EC-82-C6-5F): 192.168.100.10:55964 -> 192.168.1.11:8069 (TCP)
2021-01-04 03:50:12	Local User (MAC=30-65-EC-82-C6-5F): 192.168.100.10 DNS -> 168.95.192.1 inquire prod.data-ingestion.prod.dataops.mozgcp.net
2021-01-04 03:50:12	Local User (MAC=30-65-EC-82-C6-5F): 192.168.100.10:55955 -> 35.244.247.133:443 (TCP)
2021-01-04 03:50:12	Local User (MAC=30-65-EC-82-C6-5F): 192.168.100.10 DNS -> 168.95.192.1 inquire prod.data-ingestion.prod.dataops.mozgcp.net
2021-01-04 03:50:11	Local User (MAC=30-65-EC-82-C6-5F): 192.168.100.10 DNS -> 168.95.192.1 inquire incoming.telemetry.mozilla.org
2021-01-04 03:50:11	Local User (MAC=30-65-EC-82-C6-5F): 192.168.100.10:55954 -> 192.168.1.13:8069 (TCP)
2021-01-04 03:50:09	Local User (MAC=30-65-EC-82-C6-5F): 192.168.100.10:55952 ->

Available settings are explained as follows:

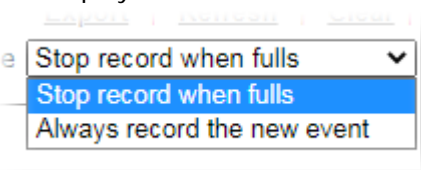
Item	Description
Enable Web Syslog	Check this box to enable Web Syslog.
Syslog Type	Select the type of Syslog info to monitor.
Export	Click to save the data as a file.
Refresh	Click to refresh this page manually.
Clear	Click to purge Syslog entries from the Web Syslog buffer.
Display Mode	<p>Two display modes are available.</p>  <p>Stop record when fulls - When the Web Syslog buffer is full, no further logging will be performed.</p> <p>Always record the new event - Events are recorded in a</p>

	FIFO manner. As the buffer gets full, oldest events are purged to make room for new events.
Time	Displays the time when the event occurred.
Message	Displays the event information.

VII-1-16 IPv6 TSPC Status

IPv6 TSPC (Tunnel Setup Protocol Client) status page could help you diagnose issues with IPv6 connections that utilize TSP.

If TSPC has configured properly, the router will display the following page when the user connects to tunnel broker successfully.

Diagnostics >> IPv6 TSPC Status

WAN1	WAN3	WAN5	WAN6	WAN7	WAN8	Refresh
<p>TSPC Enabled</p> <p>TSPC Connection Status</p> <p>Local Endpoint v4 Address : 114.44.54.220</p> <p>Local Endpoint v6 Address : 2001:05c0:1400:000b:0000:0000:0000:10b9</p> <p>Router DNS name : 888866666.broker.freenet6.net</p> <p>Remote Endpoint v4 Address : 81.171.72.11</p> <p>Remote Endpoint v6 Address : 2001:05c0:1400:000b:0000:0000:0000:10b8</p> <p>Tspc Prefixlen : 56</p> <p>Tspc Prefixlen : 56</p> <p>Tunnel Broker : amsterdam.freenet6.net</p> <p>Tunnel Status : Connected</p>						

Available settings are explained as follows:

Item	Description
Refresh	Click this link to refresh this page manually.

VII-1-17 High Availability Status

This page displays the High Availability status of all routers that belong to the same DARP (DrayTek Address resolution Protocol) group.

Vigor routers that satisfy the following conditions are considered to be in the same DARP group:

- HA enabled
- the same Redundancy method
- the same Group ID
- the same Authentication Key
- the same Management Interface

Open [Diagnostics](#)>>[High Availability Status](#).

[Diagnostics](#) >> [High Availability Status](#)

Status	Router Name	IP	Role	Stable	WAN	Sync Status	Cached Time
!	Marketing3...	192.168.100.1	Primary	No	At Least One Up - Eth	Ready <input type="button" value="Sync"/>	-

Note:

1. High Availability Status table displays 10 routers maximum. The local router will always show in the first row of this table.
2. A Status of "!" indicates that an error has occurred, refer to the [Details](#) page for more information.

Available settings are explained as follows:

Item	Description
Details/Back	Details - Click to display detailed status about HA configuration for the selected router. Back - Click to return to the previous page.
HA Setup	Click to navigate to Applications >> High Availability to modify the HA configuration.
Renew	Click to get the latest status of routers other than the primary router.
Refresh	Click to get the latest status of the primary router.
Status	"!" means an error has occurred. Refer to Detailed information and modify HA settings if required.
Router Name	Display the name of the device.
IP	Display the IPv4 address of such router.
Role	"Down" means the function of HA is disabled. "Primary" means the router is the primary HA router. "Secondary" means the router is a secondary HA router.
Stable	"No" means the primary router has not been identified yet. DARP is still negotiating. "YES" means the primary router is identified.
WAN	"At Least One UP" means that at least one WAN interface is connected to Internet. "All WANs Down" means that no WAN interface is currently

	connected to Internet.
Sync Status	<p>"Not Ready" means configuration synchronization is unable to execute, or configuration synchronization is disabled, or synchronization initialization has executed but failed.</p> <p>"Ready" means configuration synchronization is ready to execute.</p> <p>"Progressing" means configuration synchronization is in progress.</p> <p>"Fail" means configuration synchronization has executed and failed; or the model name is incorrect.</p> <p>"Equal" means the corresponding settings are equal to the primary router.</p>
Cached Time	Displays the elapsed time since the last status update of the other routers (i.e., other than the primary router).

To view detailed information of a router, click Status, Router Name IPv4 or Details, and the following page will be shown:

[Diagnostics >> High Availability Status >> Details](#)

[Local Router]		Back HA Setup Renew Refresh		
Marketing3910		192.168.100.1(FE80::21D:AAFF:FE4B:3E80)		
Role	Stable	WAN	Sync Status	Cached Time
Primary	No !	At Least One Up - Eth	Ready <input type="button" value="Sync"/>	-
<hr/>				
Config Sync Status	Not Ready		DHCPv6 Sync Status	Ready
MAC	00:1d:aa:4b:3e:80		HTTPs Port	443
Model	Vigor3910		Firmware Version	3.9.4_RC3 r1493_99_27607728
Enable High Availability	Off !		Redundancy Method	Active-Standby
Group ID	1		Priority ID	10
Authentication Key	draytek		Management Interface	LAN1
Update DDNS	Off		Protocol	IPv4
Virtual IPv4	Off !			
			LAN1	FE80::200:5EFF:FE00:101
			LAN2	FE80::200:5EFF:FE00:101
			LAN3	FE80::200:5EFF:FE00:101
			LAN4	FE80::200:5EFF:FE00:101
			LAN5	FE80::200:5EFF:FE00:101
			LAN6	FE80::200:5EFF:FE00:101
			LAN7	FE80::200:5EFF:FE00:101

VII-1-18 Authentication Information

Authentication User List

This page shows authentication requests handled by the Internal RADIUS or Local 802.1X services.

When the mouse cursor is hovered over a link under User Name, information about the RADIUS or 802.1X authentication attempt (including authentication failure information) will appear in a pop-up dialog box.

Diagnostics >> Authentication Information

Authentication User List		Authentication Information Log	
User Name	Authentication Failure Times	User Name	Authentication Failure Times
test_1	0	test_sales	0

Note:

- 1.This is the authentication list for router's **Internal RADIUS** or Local 802.1X
- 2.For those clients are authenticated by external RADIUS server, please find the information from the server.

Authentication Information Log

This page will display the complete authentication log information.

Diagnostics >> Authentication Information

Authentication User List		Authentication Information Log	
<input type="checkbox"/> Enable	Syslog Type	Radius	Display Mode
		Radius	always record the new event
		802.1X	
		ALL	
Time			Message

Available settings are explained as follows:

Item	Description
Enable	Check to enable Authentication Information Log.
Refresh	Click to refresh the Authentication Information Log.
Clear	Click to clear the Authentication Information Log.
Syslog Type	Select the type of authentication information to be displayed: Radius, 802.1X, or ALL (both Radius and 802.1X).
Display Mode	Choose the mode that the logging information will be shown. Stop record when fulls - when the buffer is full, the system will stop recording. Always record the new event - when the buffer is full, the oldest event will be purged to make room for the new event.
Time	Display the time of the event.
Message	Displays the details of the authentication event.

VII-1-19 DoS Flood Table

This page shows IP addresses that are currently engaging in DoS flood as detected by the DoS Flooding Defense mechanism. It provides useful information to network engineers (e.g., MIS engineers) to diagnose the network environment to identify potentially malicious network traffic and entities. Identified IP addresses and the destination ports used in SYN, UDP, and ICMP Flood attacks will be shown on the respective tab pages.

IP addresses that are suspected to be attacking the network can be blocked by clicking the **Block** button on the SYN Flood, UDP Flood and ICMP Flood tab pages.

Diagnostics >> DoS Flood Table

IPv4

SYN Flood	UDP Flood	ICMP Flood	Refresh
Tracing IP	Destination Port		
.....			

IPv6

SYN Flood	UDP Flood	ICMP Flood	Refresh
Tracing IP	Destination Port		
.....			

Note:

You need to enable SYN/UDP/ICMP flood defense in **Firewall >> Defense Setup** to make this table effective.



Info

The icon - (⊗) - means there is something wrong (e.g., attacking the system) with that IP address.

VII-1-20 Route Policy Diagnosis

With the analysis done by such page, possible path (static route, routing table or policy route) of the packets sent out of the router can be traced.

Diagnostics >> Route Policy Diagnosis

Test how the packets will be routed

- Mode Analyze a single packet
 Analyze multiple packets by uploading an input file

Packet Information

Protocol

Src IP

Dst IP

Dst Port

Analyze

or

Diagnostics >> Route Policy Diagnosis

Test how the packets will be routed

- Mode Analyze a single packet
 Analyze multiple packets by uploading an input file

Input File

未選擇任何檔案

([download](#) an example input file)

Analyze

Available settings are explained as follows:

Item	Description
Mode	<p>Analyze a single packet - Choose such mode to make Vigor router analyze how a single packet will be sent by a route policy.</p> <p>Analyze multiple packets... - Choose such mode to make Vigor router analyze how multiple packets in a specified file will be sent by a route policy.</p>
Packet Information	<p>Specify the nature of the packets to be analyzed by Vigor router.</p> <p>ICMP/UDP/TCP/ANY- Specify a protocol for diagnosis.</p> <p>Src IP - Type an IP address as the source IP.</p> <p>Dst IP - Type an IP address as the destination IP.</p> <p>Dst Port - Use the drop down list to specify the destination</p>

port.

Analyze - Click it to perform the job of analyzing. The analyzed result will be shown on the page..

Input File

It is available when Analyze multiple packets.. is selected as Mode.

Select - Click the download link to get a blank example file. Then, click such button to select that blank ".csv" file for saving the result of analysis.

Mode

- analyze how a packet will be sent
- analyze how multiple packets as specified in the input file will be sent

Input File

[選擇檔案](#)
[Analyze](#)



Analyze - Click it to perform the job of analyzing. The analyzed result will be shown on the page. If required, click **export analysis** to export the result as a file.

Load Balance/Route Policy >> Diagnose

Mode

- analyze how a packet will be sent
- analyze how multiple packets as specified in the input file will be sent

Input File

[選擇檔案](#) 未選擇檔案 (download an example input file)

[Analyze](#)

Analysis [export analysis](#)

Profile	Input Packet Information				Matched Route		Matched Policy			Final Result	
	Proto	Src IP	Out IP	Dst Port	Route	Priority	Policy	Priority	Failovered	Interface	Reason
LA-branch	ICMP	192.168.1.10	19.10.10.10	N/A	No Match	N/A	No Match	N/A	N/A	N/A	The packet was dropped because neither "route" or "policy" was matched
Nr-branch	TCP	192.168.1.20	20.20.20.20	9060	No Match	N/A	No Match	N/A	N/A	N/A	The packet was dropped because neither "route" or "policy" was matched
											The packet was dropped because

Note that the analysis was based on the current "load-balance/route policy" settings, we do not guarantee it will be 100% the same as the real case.

VII-1-21 Debug Logs

This page allows downloading the logs for debugging by a technician.

Diagnostics >> Debug Logs

- Basic Logs
- Full Logs
- User Defined Logs
 - Coredump Latest (within a week) Latest All
 - Slow path packet capture for 10 sec 20 sec 30 sec
 - Syslog in internal flash Today All

VII-2 Checking If the Hardware Status Is OK or Not

Follow the steps below to verify the hardware status.

1. Check the power line and WLAN/LAN cable connections.
Refer to “I-2 Hardware Installation” for details.
2. Turn on the router. Make sure the ACT LED blink once per second and the correspondent LAN LED is bright.

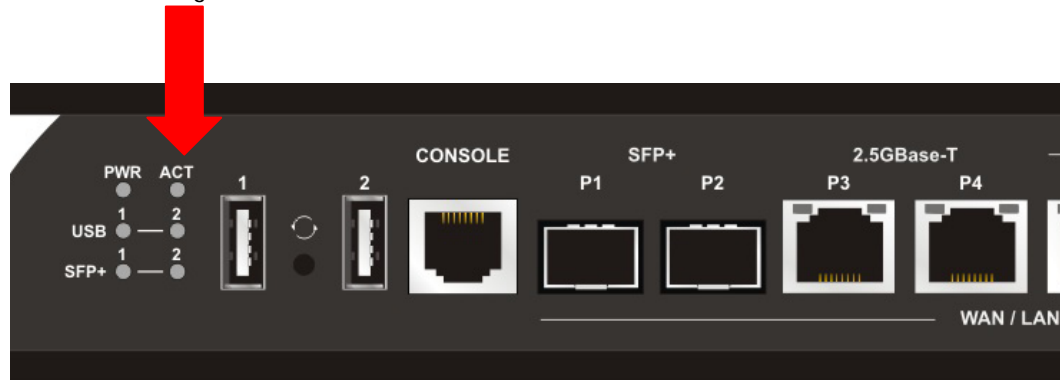

3. If not, it means that there is something wrong with the hardware status. Simply back to “I-2 Hardware Installation” to execute the hardware installation again. And then, try again.

VII-3 Checking If the Network Connection Settings on Your Computer Is OK or Not

Sometimes the link failure occurs due to the wrong network connection settings. After trying the above section, if the link is still failed, please do the steps listed below to make sure the network connection settings is OK.

For Windows



Info

The example is based on Windows 7. As to the examples for other operation systems, please refer to the similar steps or find support notes in www.DrayTek.com.

1. Open All Programs>>Getting Started>>Control Panel. Click Network and Sharing Center.



Java

Network and Sharing Center

Personalization

Recovery

2. In the following window, click Change adapter settings.

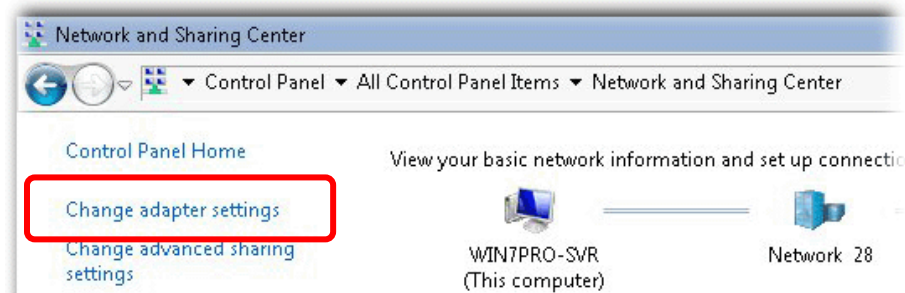

3. Icons of network connection will be shown on the window. Right-click on Local Area Connection and click on Properties.

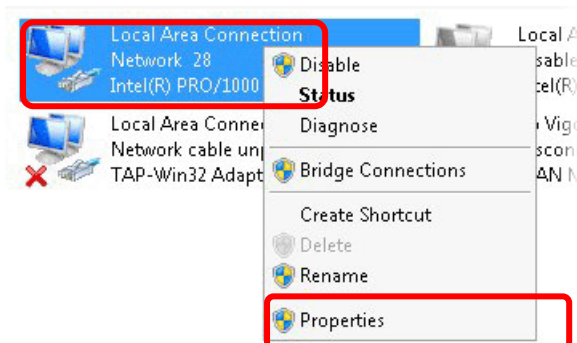

4. Select **Internet Protocol Version 4 (TCP/IP)** and then click **Properties**.

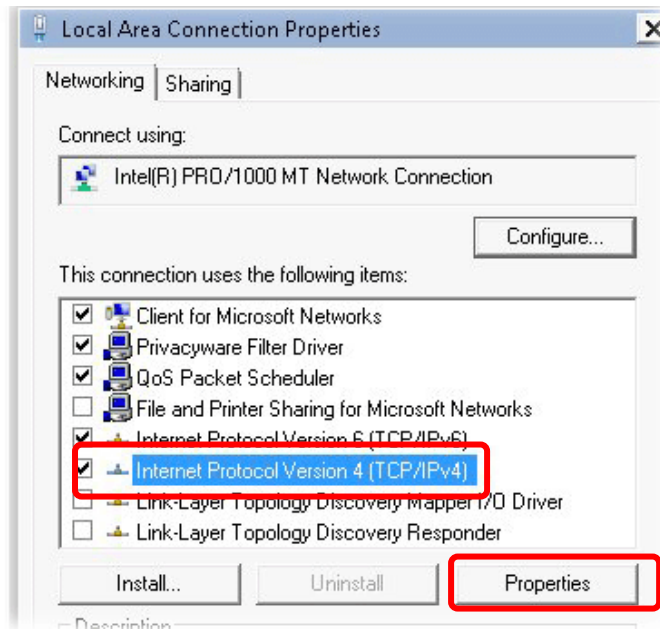

5. Select **Obtain an IP address automatically** and **Obtain DNS server address automatically**. Finally, click **OK**.

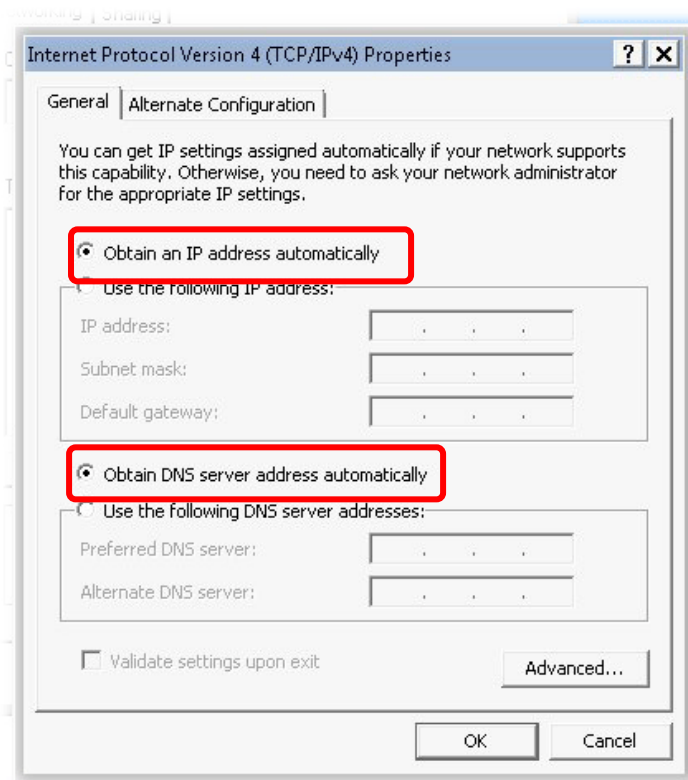

For Mac OS

1. Double click on the current used Mac OS on the desktop.
2. Open the **Application** folder and get into **Network**.
3. On the **Network** screen, select **Using DHCP** from the drop down list of Configure IPv4.

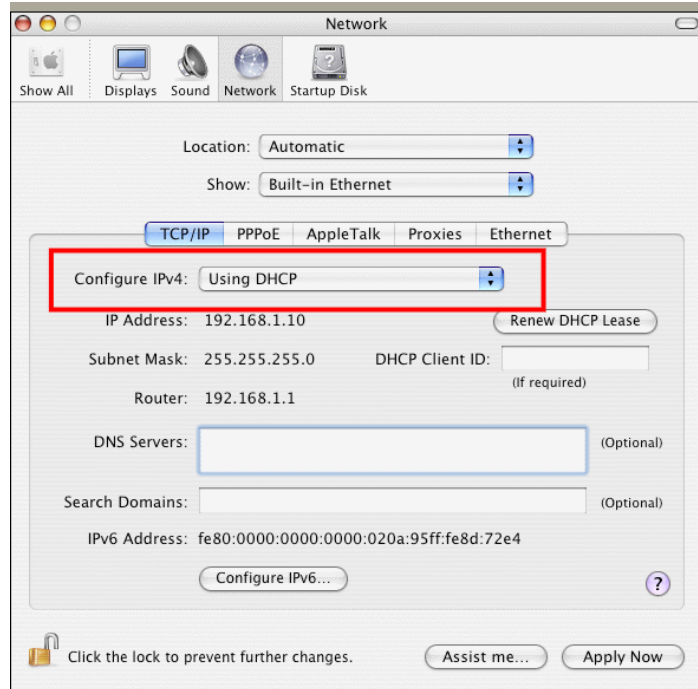

VII-4 Pinging the Router from Your Computer

The default gateway IP address of the router is 192.168.1.1. For some reason, you might need to use “ping” command to check the link status of the router. **The most important thing is that the computer will receive a reply from 192.168.1.1.** If not, please check the IP address of your computer. We suggest you setting the network connection as get IP automatically. (Please refer to the section VIII-3)

Please follow the steps below to ping the router correctly.

For Windows

1. Open the **Command Prompt** window (from **Start menu**> **Run**).
2. Type `cmd`. The DOS command dialog will appear.

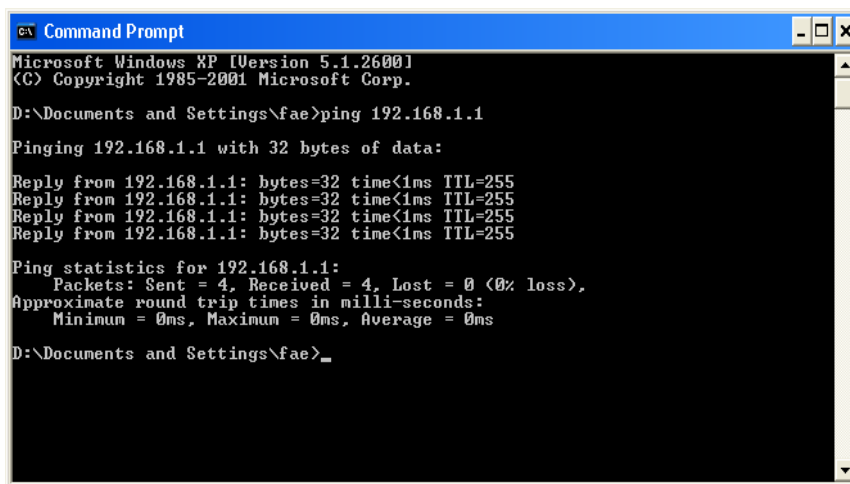

```
Command Prompt
Microsoft Windows XP [Version 5.1.2600]
(C) Copyright 1985-2001 Microsoft Corp.

D:\Documents and Settings\fae>ping 192.168.1.1

Pinging 192.168.1.1 with 32 bytes of data:

Reply from 192.168.1.1: bytes=32 time<1ms TTL=255
Reply from 192.168.1.1: bytes=32 time<1ms TTL=255
Reply from 192.168.1.1: bytes=32 time<1ms TTL=255
Reply from 192.168.1.1: bytes=32 time<1ms TTL=255

Ping statistics for 192.168.1.1:
    Packets: Sent = 4, Received = 4, Lost = 0 (0% loss),
    Approximate round trip times in milli-seconds:
        Minimum = 0ms, Maximum = 0ms, Average = 0ms

D:\Documents and Settings\fae>_
```

3. Type `ping 192.168.1.1` and press [Enter]. If the link is OK, the line of “Reply from 192.168.1.1:bytes=32 time<1ms TTL=255” will appear.
4. If the line does not appear, please check the IP address setting of your computer.

For Mac OS (Terminal)

1. Double click on the current used MacOs on the desktop.
2. Open the **Application** folder and get into **Utilities**.
3. Double click **Terminal**. The Terminal window will appear.
4. Type `ping 192.168.1.1` and press [Enter]. If the link is OK, the line of “64 bytes from 192.168.1.1: icmp_seq=0 ttl=255 time=xxx ms” will appear.

```
Terminal — bash — 80x24
Last login: Sat Jan  3 02:24:18 on ttty1
Welcome to Darwin!
Vigor10:~ draytek$ ping 192.168.1.1
PING 192.168.1.1 (192.168.1.1): 56 data bytes
64 bytes from 192.168.1.1: icmp_seq=0 ttl=255 time=0.755 ms
64 bytes from 192.168.1.1: icmp_seq=1 ttl=255 time=0.697 ms
64 bytes from 192.168.1.1: icmp_seq=2 ttl=255 time=0.716 ms
64 bytes from 192.168.1.1: icmp_seq=3 ttl=255 time=0.731 ms
64 bytes from 192.168.1.1: icmp_seq=4 ttl=255 time=0.72 ms
^C
--- 192.168.1.1 ping statistics ---
5 packets transmitted, 5 packets received, 0% packet loss
round-trip min/avg/max = 0.697/0.723/0.755 ms
Vigor10:~ draytek$
```

VII-5 Checking If the ISP Settings are OK or Not

If WAN connection cannot be up, check if the LEDs (according to the LED explanations listed on section I-1) are correct or not. If the LEDs are off, please:

- Change the **Physical Type** from **Auto negotiation** to other values (e.g., 100M full duplex).
- Next, change the physical type of modem (e.g., DSL/FTTX(GPON)/Cable modem) offered by ISP with the same value configured in Vigor router. Check if the LEDs on Vigor router are on or not.
- If not, please install an additional switch for connecting both Vigor router and the modem offered by ISP. Then, check if the LEDs on Vigor router are on or not.
- If the problem of LEDs cannot be solved by the above measures, please contact with the nearest reseller, or send an e-mail to DrayTek FAE for technical support.
- Check if the settings offered by ISP are configured well or not.

When the LEDs are on and correct, yet the WAN connection still cannot be up, please:

- Open **WAN >> Internet Access** page and then check whether the ISP settings are set correctly. Click **Details Page** of WAN1~WAN8 to review the settings that you configured previously.

WAN >> Internet Access

Internet Access			
Index	Display Name	Physical Mode / Port	Access Mode
WAN1		Fiber / P1	Static or Dynamic IP
WAN3		Ethernet / P3	None
WAN5		Ethernet / P5	PPPoE
WAN6		Ethernet / P6	Static or Dynamic IP
WAN7		Ethernet / P7	Static or Dynamic IP
WAN8		Ethernet / P8	Static or Dynamic IP

The table above shows the configuration for WAN connections. A red box highlights the 'Access Mode' column, which includes dropdown menus for each WAN entry. The dropdown for WAN5 is open, showing options: 'None', 'PPPoE', and 'Static or Dynamic IP'. To the right of each dropdown are buttons for 'Details Page' and 'IPv6'.

DHCP Client Option

VII-6 Backing to Factory Default Setting If Necessary

Sometimes, a wrong connection can be improved by returning to the default settings. Try to reset the router by software or hardware. Such function is available in **Admin Mode** only.



Info

After pressing factory default setting, you will lose all settings you did before. Make sure you have recorded all useful settings before you pressing. The password of factory default is null.

Software Reset

You can reset the router to factory default via Web page. Such function is available in **Admin Mode** only.

Go to **System Maintenance** and choose **Reboot System** on the web page. The following screen will appear. Choose **Using factory default configuration** and click **Reboot Now**. After few seconds, the router will return all the settings to the factory settings.

System Maintenance >> Reboot System

Reboot System

Do you want to reboot your router ?

- Using current configuration (Fast reboot)
- Using current configuration (Normal reboot)
- Using default configuration
- Clean Linux Applications
- Wipe out all data (personal data like certificate, WCF license, web portal ..etc.)

Reboot Now

Auto Reboot Time Schedule

Schedule Profile : , , ,

Note:

Action and Duration Time settings will be ignored.

OK

Cancel

Hardware Reset

While the router is running (ACT LED blinking), press the Factory Reset button and hold for more than 5 seconds. When you see the ACT LED blinks rapidly, please release the button. Then, the router will restart with the default configuration.

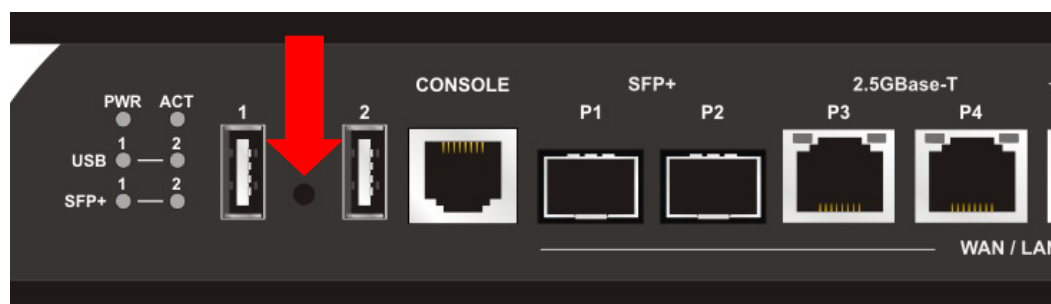

After restore the factory default setting, you can configure the settings for the router again to fit your personal request.

VII-7 Contacting DrayTek

If the router still cannot work correctly after trying many efforts, please contact your dealer for further help right away. For any questions, please feel free to send e-mail to support@DrayTek.com.

Part VIII Telnet Commands

Accessing Telnet of Vigor3912

This chapter also gives you a general description for accessing telnet and describes the firmware versions for the routers explained in this manual.

Type `cmd` and press Enter. The Telnet terminal will be open later.



In the following window, type `Telnet 192.168.1.1` as below and press Enter. Note that the IP address in the example is the default address of the router. If you have changed the default, enter the current IP address of the router.

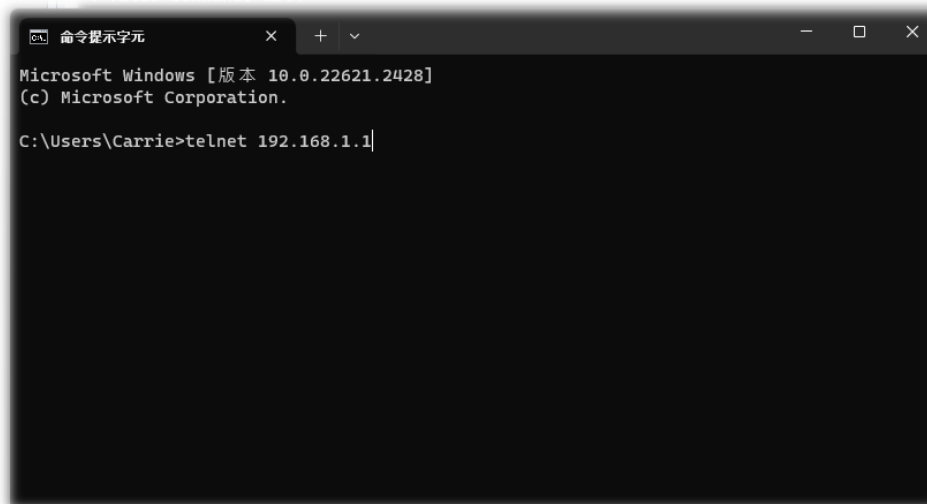

Next, type `admin/admin` for Account/Password. Then, type `?`. You will see a list of valid/common commands depending on the router that your use.

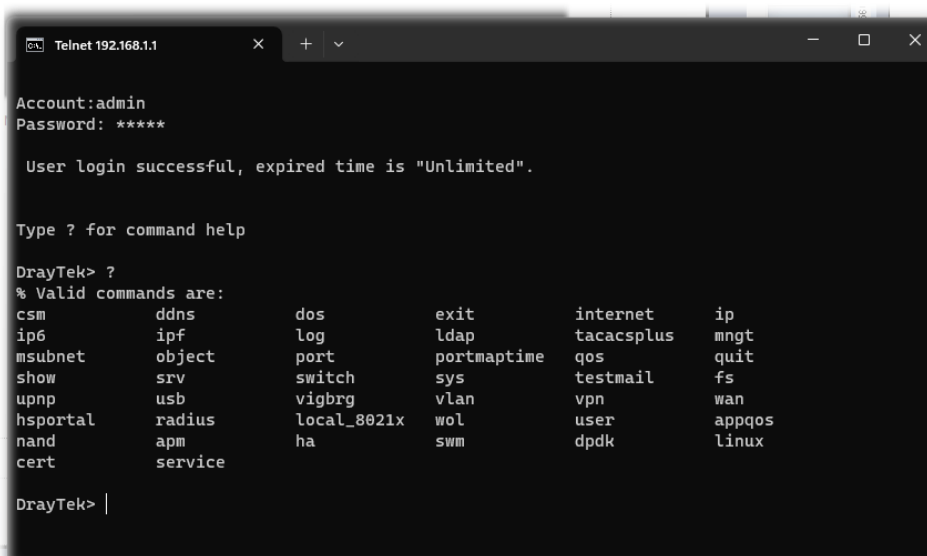

Telnet Command: csm appe prof

Commands under CSM allow you to set CSM profile to define policy profiles for different policy of IM (Instant Messenger)/P2P (Peer to Peer) application.

“csm appe prof “ is used to configure the APP Enforcement Profile name. Such profile will be applied in Default Rule of Firewall>>General Setup for filtering.

Syntax

```
csm appe prof -i INDEX [-v | -n NAME|setdefault]
```

Syntax Description

Parameter	Description
<i>INDEX</i>	Specify the index number of CSM profile, from 1 to 32.
-v	View the configuration of the CSM profile.
-n	Set a name for the CSM profile.
<i>NAME</i>	Specify a name for the CSM profile, less than 15 characters.
<i>setdefault</i>	Reset to default settings.

Example

```
> csm appe prof -i 1 -n games
The name of APPE Profile 1 was setted.
```

Telnet Command: csm appe set

It is used to configure group settings for IM/P2P/Protocol and Others in APP Enforcement Profile.

Syntax

```
csm appe set -i INDEX -v GROUP
```

```
csm appe set -i INDEX -e AP_IDX
```

```
csm appe set -i INDEX -d AP_IDX
```

```
csm appe set -i INDEX -p AP_IDX
```

```
csm appe set -i INDEX -q AP_IDX
```

Syntax Description

Parameter	Description
<i>INDEX</i>	Specify the index number of CSM profile, from 1 to 32.
-v <i>GROUP</i>	View the IM/P2P/Protocol and Others configuration of the CSM profile. <i>GROUP</i> - Specify the category of the application. Available options are: IM, P2P, Protocol and Others.
-e <i>AP_IDX</i>	Enable to block specific application. <i>AP_IDX</i> - Specify the index number of the APP.
-d <i>AP_IDX</i>	Disable to block specific application. <i>AP_IDX</i> - Specify the index number of the APP.
-p <i>AP_IDX</i>	Enable the policy route for the action of specific application. <i>AP_IDX</i> - Specify the index number of the APP.

<code>-q AP_IDX</code>	Disable the policy route for the action of specific application. AP_IDX - Specify the index number of the APP.
<code>AP_IDX</code>	Each application has independent index number for identification in CLI command. Specify the index number of the application here. If you have no idea of the index number, do the following (Take IM as an example): Type "csm appe set -l 1 -v IM", the system will list all of the index numbers of the applications categorized under IM.

Example

```
> csm appe set -i 1 -e 1
Profile 1 - games: AliWW is enabled.
```

Telnet Command: csm appe show

It is used to display group (IM/P2P/Protocol and Others) information APP Enforcement Profile.

Syntax

`csm appe show [-a/-i/-p/-t/-m]`

Syntax Description

Parameter	Description
<code>-a</code>	View the configuration status for All groups.
<code>-i</code>	View the configuration status of IM group.
<code>-p</code>	View the configuration status of P2P group.
<code>-t</code>	View the configuration status of protocol group.
<code>-m</code>	View the configuration status of Others group.

Example

```
>csm appe show -t
      Type      Index      Name      Version
-----
      Protocol   44      BGP      4
      Protocol   45      DNS
      Protocol   46      FTP
      Protocol   47      GIT
      Protocol   48      H.323
      Protocol   49      HTTP      1.1
      Protocol   50      IBM Informix
      Protocol   51      IBM DB2
      Protocol   52      ICMP
      Protocol   53      IMAP/IMAP STARTTLS      4.1
      Protocol   54      IRC      2.4.0
```

Protocol	55	Microsoft SQL	
Protocol	56	MQTT	
Protocol	57	MySQL	
Protocol	58	NNTP	
Protocol	59	NNTPS	
Protocol	60	NTP	
Protocol	61	Oracle	11g
Protocol	62	POP3/POP3 STARTTLS	
Protocol	63	PostgreSQL	
Protocol	64	QUIC	Q025
--- MORE --- ['q': Quit, 'Enter': New Lines, 'Space Bar': Next Page] ---			

Telnet Command: csm appe config

It is used to display the configuration status (enabled or disabled) for IM/P2P/Protocol/Other applications.

Syntax

`csm appe config -v INDEX -i`

`csm appe config -v INDEX -p`

`csm appe config -v INDEX -t`

`csm appe config -v INDEX -m`

`csm appe config -v INDEX -r`

Syntax Description

Parameter	Description
<i>INDEX</i>	Specify the index number of CSM profile, from 1 to 32.
<i>-i</i>	View the configuration status of IM group.
<i>-p</i>	View the configuration status of P2P group.
<i>-t</i>	View the configuration status of protocol group.
<i>-m</i>	View the configuration status of Others group.
<i>-r</i>	View the configuration setting of the APPE profile for the route policy.

Example

```
> csm appe config -v 1 -m
```

OTHERS	Tunneling	75	CloudFlare	Disable
OTHERS	Tunneling	76	DNSCrypt	Disable
OTHERS	Tunneling	77	DynaPass	Disable
OTHERS	Tunneling	78	FreeGate	Disable
OTHERS	Tunneling	79	Hotspot Shield	Disable
OTHERS	Tunneling	80	HTTP Tunnel	Disable
OTHERS	Tunneling	81	HTTP Proxy	Disable
OTHERS	Tunneling	82	LogMeIn Hamachi	Disable
OTHERS	Tunneling	83	MS Teredo	Disable

OTHERS	Tunneling	84	OpenDNS	Disable
OTHERS	Tunneling	85	OpenVPN	Disable
OTHERS	Tunneling	86	PGPNet	Disable
OTHERS	Tunneling	87	Ping Tunnel	Disable
OTHERS	Tunneling	88	RealTunnel	Disable
OTHERS	Tunneling	89	Skyfire	Disable
OTHERS	Tunneling	90	SOCKS4/SOCKS5	Disable
OTHERS	Tunneling	91	SoftEther VPN	Disable
OTHERS	Tunneling	92	TinyVPN	Disable
OTHERS	Tunneling	93	Tor	Disable
OTHERS	Tunneling	94	UltraVPN	Disable
OTHERS	Tunneling	95	VNN	Disable
OTHERS	Tunneling	96	Wujie/UltraSurf	Disable
OTHERS	Tunneling	97	ZenMate	Disable
OTHERS	Stream	98	FlashVideo	Disable
--- MORE --- ['q': Quit, 'Enter': New Lines, 'Space Bar': Next Page] ---				

Total 89 APPs				
>				

Telnet Command: csm ucf

It is used to configure settings for URL control filter profile.

Syntax

`csm ucf show`

`csm ucf setdefault`

`csm ucf msg MSG`

`csm ucf obj INDEX [-n PROFILE_NAME | -I [P|B|A] | uac | wf]`

`csm ucf obj INDEX -n PROFILE_NAME`

`csm ucf obj INDEX -p VALUE`

`csm ucf obj INDEX -I P|B|A`

`csm ucf obj INDEX uac`

`csm ucf obj INDEX wf`

Syntax Description

Parameter	Description
<i>show</i>	Display all of the profiles.
<i>setdefault</i>	Return to default settings for all of the profile.
<i>msg MSG</i>	Set the administration message. MSG means the content (less than 255 characters) of the message itself.
<i>obj</i>	Specify the object for the profile.
<i>INDEX</i>	Specify the index number of CSM profile, from 1 to 8.
<i>-n</i>	Set the profile name.
<i>PROFILE_NAME</i>	Specify the name of the profile (less than 16 characters)
<i>-p</i>	Set the priority (defined by the number specified in VALUE) for the

	profile.
<i>VALUE</i>	Number 0 to 3 represent different conditions. 0: It means Bundle: Pass. 1: It means Bundle: Block. 2: It means Either: URL Access Control First. 3: It means Either: Web Feature First.
<i>-l</i>	It means the log type of the profile. They are: P: Pass, B: Block, A: All,
<i>MSG</i>	Specify the Administration Message, less then 255 characters
<i>uac</i>	Set URL Access Control part.
<i>wf</i>	Set Web Feature part.

Example

```

> csm ucf obj 1 -n game -l B
Profile Index: 1
Profile Name:[game]
> csm ucf obj 1 -p 0
Log:[block]
Priority Select : [Bundle : Pass]
-----
URL Access Control
[ ]Enable URL Access Control   Action:[pass]
[ ]Prevent web access from IP address.
  No  Obj NO.   Object Name
-----

  No  Grp NO.   Group Name
-----

```

Telnet Command: csm ucf obj INDEX uac

It means to configure the settings regarding to URL Access Control (uac).

Syntax

```

csm ucf obj INDEX uac -v
csm ucf obj INDEX uac -e
csm ucf obj INDEX uac -d
csm ucf obj INDEX uac -a P/B
csm ucf obj INDEX uac -i E/D
csm ucf obj INDEX uac -o KEY_WORD_Object_Index
csm ucf obj INDEX uac -g KEY_WORD_Group_Index

```

Syntax Description

Parameter	Description
<i>INDEX</i>	Specify the index number of CSM profile, from 1 to 8.

<i>-v</i>	View the protocol configuration of the CSM profile.
<i>-e</i>	Enable the function of URL Access Control.
<i>-d</i>	Disable the function of URL Access Control.
<i>-a</i>	Set the action of specific application, P or B. B: Block. The web access meets the URL Access Control will be blocked. P: Pass. The web access meets the URL Access Control will be passed.
<i>-i</i>	Prevent the web access from any IP address. E: Enable the function. The Internet access from any IP address will be blocked. D: Disable the function.
<i>-o</i>	Set the keyword object.
<i>KEY_WORD_Object_Index</i>	Specify the index number of the object profile.
<i>-g</i>	Set the keyword group.
<i>KEY_WORD_Group_Index</i>	Specify the index number of the group profile.

Example

```

> csm ucf obj 1 uac -i E
Log:[block]
Priority Select : [Bundle : Pass]
-----
URL Access Control
[ ]Enable URL Access Control   Action:[pass]
[v]Prevent web access from IP address.
  No  Obj NO.   Object Name
-----

  No  Grp NO.   Group Name
-----

> csm ucf obj 1 uac -a B
Log:[block]
Priority Select : [Bundle : Pass]
-----
URL Access Control
[ ]Enable URL Access Control   Action:[block]
[v]Prevent web access from IP address.
  No  Obj NO.   Object Name
-----

  No  Grp NO.   Group Name
-----

```

Telnet Command: csm ucf obj INDEX eac

It means to configure the settings regarding to URL Exception Access (eac).

Syntax

```
csm ucf obj INDEX eac -v
csm ucf obj INDEX eac -e
csm ucf obj INDEX eac -d
csm ucf obj INDEX eac -o KEY_WORD_Object_Index
csm ucf obj INDEX eac -g KEY_WORD_Group_Index
```

Syntax Description

Parameter	Description
<i>INDEX</i>	Specify the index number of CSM profile, from 1 to 8.
-v	View the protocol configuration of the CSM profile.
-e	Enable the function of URL Exception Access control.
-d	Disable the function of URL Exception Access control.
-o	Set the keyword object.
<i>KEY_WORD_Object_Index</i>	Specify the index number of the object profile.
-g	Set the keyword group.
<i>KEY_WORD_Group_Index</i>	Specify the index number of the group profile.

Example

```
> csm ucf obj 1 eac -e
Enable Exception List

[v]Enable Exception List
  No  Obj NO.   Object Name
-----
  No  Grp NO.   Group Name
-----

> csm ucf obj 1 eac -o 1
[v]Enable Exception List
  No  Obj NO.   Object Name
-----
  1   [1]       [mailforuse]

  No  Grp NO.   Group Name
-----

>
```

Telnet Command: csm ucf obj INDEX wf

It means to configure the settings regarding to Web Feature (wf).

Syntax

```

csm ucf obj INDEX wf -v
csm ucf obj INDEX wf -e
csm ucf obj INDEX wf -d
csm ucf obj INDEX wf -a P/B
csm ucf obj INDEX wf -s WEB_FEATURE
csm ucf obj INDEX wf -u WEB_FEATURE
csm ucf obj INDEX wf -f File_Extension_Object_index

```

Syntax Description

Parameter	Description
<i>INDEX</i>	Specify the index number of CSM profile, from 1 to 8.
<i>-v</i>	View the protocol configuration of the CSM profile.
<i>-e</i>	Enable the restriction of web feature.
<i>-d</i>	Disable the restriction of web feature.
<i>-a</i>	Set the action of web feature, P or B. B: Block. The web access meets the web feature will be blocked. P: Pass. The web access meets the web feature will be passed.
<i>-s</i>	Enable the the Web Feature configuration. Features available for configuration are: c: Cookie p: Proxy u: Upload
<i>-u</i>	Cancel the web feature configuration.
<i>-f</i>	Set the file extension object index number.
<i>File_Extension_Object_index</i>	Type the index number (1 to 8) for the file extension object.

Example

```

> csm ucf obj 1 wf -s c
-----
Web Feature
[ ] Enable Restrict Web Feature   Action:[pass]

File Extension Object Index : [0] Profile Name : []

[V] Cookie [ ] Proxy [ ] Upload

```

Telnet Command: csm wcf

It means to configure the settings regarding to web control filter (wcf).

Syntax

```

csm wcf show
csm wcf look
csm wcf cache
csm wcf server WCF_SERVER
csm wcf msg MSG
csm wcf setdefault

```

csm wcf obj *INDEX -v*
 csm wcf obj *INDEX -a P/B*
 csm wcf obj *INDEX -n PROFILE_NAME*
 csm wcf obj *INDEX -I P/B/A*
 csm wcf obj *INDEX -o KEY_WORD Object Index*
 csm wcf obj *INDEX -g KEY_WORD Group Index*
 csm wcf obj *INDEX -w E/D/P/B*
 csm wcf obj *INDEX -s CATEGORY/WEB_GROUP*
 csm wcf obj *INDEX -u CATEGORY/WEB_GROUP*

Syntax Description

Parameter	Description
<i>show</i>	Display the web content filter profiles.
<i>Look</i>	Display the license information of WCF.
<i>Cache</i>	Set the cache level for the profile.
<i>Server WCF_SERVER</i>	Set web content filter server.
<i>Msg MSG</i>	Set the administration message. MSG means the content (less than 255 characters) of the message itself.
<i>setdefault</i>	Return to default settings for all of the profile.
<i>obj</i>	Specify the object profile.
<i>INDEX</i>	Specify the index number of web content filter profile, from 1 to 8.
<i>- v</i>	View the web content filter profile.
<i>-a</i>	Set the action of web content filter profile, P or B. B: Block. The web access meets the web feature will be blocked. P: Pass. The web access meets the web feature will be passed.
<i>-n</i>	Set the profile name.
<i>PROFILE_NAME</i>	Specify the name of the profile (less than 16 characters)
<i>-I</i>	It means the log type of the profile. They are: P: Pass, B: Block, A: All
<i>-o</i>	Set the keyword object.
<i>KEY_WORD_Object_Index</i>	Specify the index number of the object profile.
<i>-g</i>	Set the keyword group.
<i>KEY_WORD_Group_Index</i>	Specify the index number of the group profile.
<i>-w</i>	Set the action for the black and white list. E: Enable, D: Disable, P: Pass, B: Block
<i>-s</i>	It means to choose the items under CATEGORY or WEB_GROUP.
<i>-u</i>	It means to discard items under CATEGORY or WEB_GROUP.
<i>WEB_GROUP</i>	"Security", "Parent Control ", "Productivity", "General Use"
<i>CATEGORY</i>	Includes: "Bot Nets", "DNS Over HTTPS", "Hacking", "Keyloggers and

	<p>Monitoring", "Malware Sites", "Parked Domains", "Phishing and Other Frauds", "Proxy Avoidance and Anonymizers", "SPAM URLs", "Spyware and Adware"</p> <p>"Abortion", "Abused Drugs", "Adult and Pornography", "Alcohol and Tobacco", "Cheating", "Cult and Occult", "Gross", "Hate and Racism", "Illegal", "Low-THC Cannabis Products", "Marijuana", "Nudity", "Questionable", "Self Harm", "Sex Education", "Swimsuits and Intimate Apparel", "Violence", "Weapons"</p> <p>"Auctions", "Computer and Internet Info", "Content Delivery Networks", "Dating", "Gambling", "Games", "Home and Garden", "Hunting and Fishing", "Image and Video Search", "Individual Stock Advice and Tools", "Internet Communications", "Job Search", "Motor Vehicles", "Music", "Pay to Surf", Peer to Peer", "Personal Storage", "Real Estate", "Shareware and Freeware", "Shopping", "Social Networking", "Sports", "Streaming Media", "Training and Tools", "Web Advertisements", "Web Hosting"</p> <p>"Business and Economy", "Computer and Internet Security", "Dead sites", "Dynamically Generated Content ", "Educational Institutions", "Entertainment and Arts", "Fashion and Beauty", "Financial Services", "Government", "Health and Medicine", "Internet Portals"</p>
--	---

Example

```

> csm wcf obj 1 -n test_wcf
Profile Index: 1
Profile Name:[test_wcf]
[ ]White/Black list
Action:[block]
  No  Obj NO.   Object Name
  ---  ---
  No  Grp NO.   Group Name
  ---  ---
Action:[block]
Log:[block]
-----
Security
[ ]Bot Nets           [ ]DNS Over HTTPS
[ ]Hacking            [ ]Keyloggers and Monitoring
[ ]Malware Sites     [ ]Parked Domains
[ ]Phishing and Other Frauds  [ ]Proxy Avoidance and Anonymizers
[ ]SPAM URLs         [ ]Spyware and Adware
-----
Parent Control
[v]Abortion           [v]Abused Drugs

```

```

[v]Adult and Pornography      [v]Alcohol and Tobacco
[v]Cheating                   [v]Cult and Occult
[v]Gross                       [v]Hate and Racism
[v]Illegal                     [v]Low-THC Cannabis Products
[v]Marijuana                   [v]Nudity
[v]Questionable               [v]Self Harm
[v]Sex Education               [v]Swimsuits and Intimate Apparel
[v]Violence                    [v]Weapons
-----

Productivity

[ ]Auctions                    [ ]Computer and Internet Info
[ ]Content Delivery Networks  [ ]Dating
[ ]Gambling                    [ ]Games
[ ]Home and Garden             [ ]Hunting and Fishing
[ ]Image and Video Search      [ ]Individual Stock Advice and Tools
[ ]Internet Communications     [ ]Job Search
[ ]Motor Vehicles              [ ]Music
[ ]Pay to Surf                 [ ]Peer to Peer
[ ]Personal Storage            [ ]Real Estate
[ ]Shareware and Freeware      [ ]Shopping
[ ]Social Networking           [ ]Sports
[ ]Streaming Media             [ ]Training and Tools
[ ]Web Advertisements          [ ]Web Hosting
-----

General Use

[ ]Business and Economy        [ ]Computer and Internet Security
[ ]Dead sites                  [ ]Dynamically Generated Content
[ ]Educational Institutions    [ ]Entertainment and Arts
[ ]Fashion and Beauty          [ ]Financial Services
[ ]Government                  [ ]Health and Medicine
[ ]Internet Portals

>

```

Telnet Command: `csm dnsf`

It means to configure the settings regarding to DNS filter.

Syntax

`csm dnsf enable ON/OFF`

`csm dnsf syslog N/P/B/A`

`csm dnsf wcf INDEX`

`csm dnsf ucf INDEX`

csm dnsf cachetime *CACHE_TIME*
 csm dnsf blockpage *show/on/off*
 csm dnsf profile_show
 csm dnsf profile_edit *INDEX*
 csm dnsf profile_edit *INDEX -n PROFILE_NAME*
 csm dnsf profile_edit *INDEX -I P/B/A*
 csm dnsf profile_edit *INDEX -w WCF_PROFILE*
 csm dnsf profile_edit *INDEX -u UCF_PROFILE*
 csm dnsf profile_edit *INDEX -c CACHE_TIME*
 csm dnsf profile_setdefault
 csm dnsf local_bw *e/d/p/b/a/g/o/s/c*

Syntax Description

Parameter	Description
<i>enable</i>	Enable or disable DNS Filter. ON: enable. OFF: disable.
<i>syslog</i>	Determine the content of records transmitting to Syslog. P: Pass. Records for the packets passing through DNS filter will be sent to Syslog. B: Block. Records for the packets blocked by DNS filter will be sent to Syslog. A: All. Records for the packets passing through or blocked by DNS filter will be sent to Syslog. N: None. No record will be sent to Syslog.
<i>WCF INDEX</i>	Specify a WCF profile (1 to 8) as the base of DNS filtering. Type a number to indicate the index number of WCF profile (1 is first profile, 2 is second profile, and so on ...).
<i>UCF INDEX</i>	Specify a UCF profile (1 to 8) as the base of DNS filtering. Type a number to indicate the index number of UCF profile (1 is first profile, 2 is second profile, and so on ...).
<i>cachetime CACHE_TIME</i>	CACHE_TIME: It means to set the time for cache to live (available values are 1 to 24; 1 is one hour, 2 is two hours, and so on ...) for DNS filter.
<i>blockpage</i>	DNS sends block page for redirect port. When a web page is blocked by DNS filter, the router system will send a message page to describe that the page is not allowed to be visited. ON: Enable the function of displaying message page. OFF: Disable the function of displaying message page. SHOW: Display the function of displaying message page is ON or OFF.
<i>profile_show</i>	Display the table of the DNS filter profile.
<i>profile_edit</i>	Modify the content of the DNS filter profile.
<i>-n PROFILE_NAME</i>	PROFILE_NAME: Type the name of the DNS filter profile that you want to modify.
<i>-I P/B/A</i>	Specify the log type of the profile. P: Pass. B: Block. A: All.
<i>-w WCF_PROFILE</i>	WCF_PROFILE: Type the index number of the WCF profile.

<code>-u UCF_PROFILE</code>	UCF_PROFILE: Type the index number of the UCF profile.
<code>-c CACHE_TIME</code>	-c means to set the cache time for DNS filter. CACHE_TIME: It means to set the time for cache to live (available values are 1 to 24; 1 is one hour, 2 is two hours, and so on ...) for DNS filter.
<code>profile_setdefault</code>	Reset to factory default setting.
<code>local_bw e/d/p/b/a/g/o/s/c</code>	Set the Black/White List of DNS Filter Local Setting. e: Enable the function of black/white list. d: Disable the function of black/white list. p: Set the action as "Pass". b: Set the action as "Block". a 0/1/2/3/4 [value]: Set the address type. 0=mask, 1=single, 2=any, 3=range, 4=group and objects g item_number group_index: Select the group index (for the address type set with 4, group and objects) item_number=1 or 2 (group 1 or group 2) group_index=1 to 192 o item_number object_index: Select the object index (for the address type set with 4, group and objects) item_number=1 or 2 (object 1 or object 2) object_index=1 to 32 s: Show the config setting. c: Clear the config setting and reset to factory default settings.

Example

```

> csm dnsf profile_setdefault
setdefault!!!
>csm dnsf cachetime 20
dns cache time set up!!!
> csm dnsf local_bw e
Enable the Block and White List.
> csm dnsf local_bw a 1 192.168.1.11
Address Type: 0:mask, 1:single, 2:any, 3:range, 4:object and group
Set the [SINGLE] Address type
> csm dnsf local_bw s
Show Block/White List information for DNS Filter Local Setting
Block/White List:[ENABLE]
Action:[PASS]
Address type:[SINGLE]
Start ip address:[192.168.1.11]
End/Mask ip address:[0.0.0.0]
Group 1:[0]
Group 2:[0]
Object 1:[0]
Object 2:[0]
>

```

Telnet Command: ddns enable

This command allows users to enable or disable the DDNS service.

Syntax

`ddns enable [0/1]`

Syntax Description

Parameter	Description
-----------	-------------

0/1	0 - Disable the DDNS service. 1 - Enable the DDNS service.
-----	---

Example

```
> ddns enable 1
  Enable Dynamic DNS Setup
>
```

Telnet Command: ddns set

This command allows users to set Dynamica DNS account.

Syntax

ddns set *option* <value>

Syntax Description

Parameter	Description
-i <value>	It means index number of Dynamic DNS Account. <value>=1-6
-S <value>	It means to specify Service Provider. If user want to set User-Defined page, value must select 1. <value>= 1-19 1: User-Defined 2:3322 DDNS (www.3322.org) 3: ChangeIP.com (www.changeip.com) 4:ddns.com.cn (www.ddns.com.cn) 5: DtDNS (www.dtdns.com) 6: dyn.com (www.dyn.com) 7: DynAccess (www.dynaccess.com) 8: dynami.co.za (www.dynami.co.za) 9: freedns.afraid.org (freedns.afraid.org) 10: NO-IP.COM Free (www.no-ip.com) 11: opendns.com (www.opendns.com) 12: OVH (www.ovh.com) 13: Strato (www.strato.eu) 14: TwoDNS (www.twodns.de) 15: TZO (www.tzo.com) 16: ubddns.org (ubddns.org) 17: Viettel DDNS (vddns.vn) 18: vigorddns.com (www.vigorddns.com) 19: ZoneEdit DDNS (dynamic.zoneedit.com)
T <value>	It means to type Service Type. <value>= 1-3 1: Dynamic 2: Custom 3: Static
-D <Host Name> <sub Domain Name>	It means to type Domain Name. i.e: Account index 1 setting Domain Name for Dynamic Service Type

	<pre>>> ddns set -i 1 -T 1 -D "host ddns.com.cn"</pre> <p>i.e: Account index 2 setting Domain Name for Custom Service Type</p> <pre>>> ddns set -i 2 -T 2 -D "domain name"</pre> <p>i.e: Account index 3 setting Domain Name for Static Service Type</p> <pre>>> ddns set -i 3 -T 3 -D "domain name"</pre>
<i>-L <value></i>	<p>It means to type Login Name. [value]: limit up to 64 characters</p>
<i>-P <value></i>	<p>It means to type Password. [value]: limit up to 24 characters</p>
<i>-E <value></i>	<p>It means to enable /disable Dynamic DNS Account. <value>=0-1 0: Disable 1: Enable</p>
<i>-W <value></i>	<p>It means to specify WAN Interface. <value>=1-14 1: WAN1 First 2: WAN1 Only 3: WAN2 First 4: WAN2 Only 5: WAN3 First 6: WAN3 Only 7: WAN4 First 8: WAN4 Only 9: WAN5 First 10: WAN5 Only 11: WAN 6 First 12: WAN6 Only example: To set WAN Interface: WAN1 First</p>
<i>-C <value></i>	<p>It means to enable /disable Wildcards. <value>=0-1 0: Disable 1: Enable</p>
<i>-B <value></i>	<p>It means to enable / disable Backup MX. <value>=0-1 0: Disable 1: Enable</p>
<i>-M <value></i>	<p>It means to type Mail Extender. [value]: limit up to 60 characters</p>
<i>-R <value></i>	<p>It means to type Determine Real WAN IP. <value>=0-1 0: WAN IP, 1: Internet IP</p>
<i>-H <value></i>	<p>It means to type User-Defined Provider Host. <value>= limit up to 64 characters</p>
<i>-A <value></i>	<p>It means to type User-Defined Service API. <value>= limit up to 256 characters</p>
<i>-a <value></i>	<p>It means to type User-Defined Auth Type. <value>=0-1 0: basic</p>

	1: URL
-N <value>	It means to type User-Defined Connection Type. <value>=0-1 0: Http 1: Https
-O <value>	It means to type User-Defined Server Response. <value>: limit up to 32 characters

Example

```
> ddns set -i 1 -S 6 -T 1 -D "hostname dnsalias.net" -L user1 -P pwd1
> Save OK
```

Telnet Command: ddns log

Displays the DDNS log.

Example

```
> ddns log
>
```

Telnet Command: ddns time

Sets and displays the DDNS time.

Syntax

`ddns time <update in minutes>`

Syntax Description

Parameter	Description
<i>Update in minutes</i>	Enter the value as DDNS time. The range is from 1 to 14400.

Example

```
> ddns time
ddns time <update in minutes>
Valid: 1 ~ 14400
%Now: 14400
> ddns time 1000
> ddns time
Ddns time <update in minutes>
Valid: 1 ~ 14400
%Now: 1000
>
```

Telnet Command: ddns forceupdate

This command will update DDNS automatically.

Example

```
> ddns forceupdate
Now updating DDNS ...
Please check result by using command "ddns log"
```

Telnet Command: ddns setdefault

This command will return DDS with factory default settings.

Example

```
>ddns setdefault
>Set to Factory Default.
```

Telnet Command: ddns show

This command allows users to check the content of selected DDNS account.

Syntax

ddns show -i <value>

Syntax Description

Parameter	Description
-i <value>	Display the content of selected DDNS account. [value]: value must be between 1-6

Example

```
> ddns show -i 1
-----
Index: 1
[ ] Enable Dynamic DNS Account
WAN Interface: WAN1 First
Service Provider: dyn.com (www.dyn.com)
Service Type: Dynamic
Domain Name: [].[]
Login Name:
[ ] Wildcards
[ ] Backup MX
Mail Extender:
Determine Real WAN IP: WAN IP
>
```

Telnet Command: dos

This command allows users to configure the settings for DoS defense system.

Syntax

dos <-V / D / A>

dos <-s ATTACK_F <THRESHOLD><TIMEOUT>>

dos <-a / e <ATTACK_F><ATTACK_0> / d <ATTACK_F><ATTACK_0>>

dos <-o >LOG_TYPE>/p <LOG_TYPE>/l <LOG_TYPE>>

dos -P <add4/remove4><type><value> |<add6/remove6><type><value> | <show>| remove4 all |remove6 all>

dos -B <add4/remove4><type><value> |<add6/remove6><type><value> | <show>| remove4 all |remove6 all>

dos -o <0/1>

dos -p <0/1>

dos -l <0/1/2/3>

dos -f <0/1/show>

dos -i </1/2/3/4/show>

Syntax Description

Parameter	Description
-V	View the configuration of DoS defense system.
-D	Deactivate the DoS defense system.
-A	Activate the DoS defense system.
-s	Enable the defense function for a specific attack and set its parameter(s).
ATTACK_F	Specify the name of flooding attack(s) or portscan, e.g., synflood, udpflood, icmpflood, or postscan.
THRESHOLD	It means the packet rate (packet/second) that a flooding attack will be detected. Set a value larger than 20.
TIMEOUT	It means the time (seconds) that a flooding attack will be blocked. Set a value larger than 5.
-a	Enable the defense function for all attacks listed in ATTACK_0.
-e	Enable defense function for a specific attack(s).
ATTACK_0	Specify a name of the following attacks: ip_option, tcp_flag, land, teardrop, smurf, pingofdeath, traceroute, icmp_frag, syn_frag, unknow_proto, fraggle.
-d	Disable the defense function for a specific attack(s).
-P [add4/remove4] [type] [value] [add6/remove6] [type] [value] [show] remove4 all remove6 all]	<p>Add or remove the IPv4/IPv6 address in the white passing IP list.</p> <p>add4/remove4: Add /remove an IPv4/IPv6 address to/from the whitelist.</p> <p>add6/remove6: Add/remove an IPv6 address to/from the whitelist.</p> <p>Type: Two types, -i and -c. In which, "-i" means the IPv4 address and "-c" means the country object.</p> <p>Value: Enter the IP address for -i; enter the index number of the country object profile.</p> <p>Show: Display the whitelist.</p>
-B [add4/remove4] [type] [value] [add6/remove6] [type] [value] [show] remove4 all remove6 all]	<p>Add or remove the IPv4/IPv6 address in the black blocking IP list.</p> <p>add4/remove4: Add /remove an IPv4/IPv6 address to/from the blacklist.</p> <p>add6/remove6: Add/remove an IPv6 address to/from the blacklist.</p> <p>Type: Two types, -i and -c. In which, "-i" means the IPv4 address and "-c" means the country object.</p> <p>Value: Enter the IP address for -i; enter the index number of the country object profile.</p> <p>Show: Display the blacklist.</p>
-o <0/1>	<p>Enable/Disable dos defense log.</p> <p>0: Disable</p>

	1: Enable
-p <0/1>	Enable/Disable spoofing defense log. 0: Disable 1: Enable
-l <0/1/2/3>	Enable/Disable dos defense black/white list log. 0: None 1: White list 2: Black List 3: All
-f <0/1/show>	Set the priority of white list / black list. 0: White list 1: Black List show: Show the setting result
-i </1/2/3/4/show>	Set the time interval for sending the log. 1: 30 seconds 2: 60 seconds 3: 180 seconds 4: 300 seconds

Example

```
>dos -A
The Dos Defense system is Activated
>dos -s synflood 50 10
Synflood is enabled! Threshold=50 <pke/sec> timeout=10 <pke/sec>
```

Telnet Command: exit

Type this command will leave telnet window.

Telnet Command: Internet

This command allows you to configure detailed settings for WAN connection.

Syntax

internet -W n -M n [-<command> <parameter> | ...]

Syntax Description

Parameter	Description
-W n	W means to set WAN interface. 1=WAN1, 2=WAN2,.... Default is WAN1.
-M n	M means to set Internet Access Mode (Mandatory) and n means different modes (represented by 0 - 7) n=0: Offline n=1: PPPoE n=2: Dynamic IP n=3: Static IP n=4: PPTP with Dynamic IP, n=5: PPTP with Static IP, n=6: L2TP with Dynamic IP

	n=7: L2TP with Static IP
<i><command><parameter>[/...]</i>	The available commands with parameters are listed below. [...] <i>means that you can type in several commands in one line.</i>
-S <i><isp name></i>	Set ISP Name (max. 23 characters).
-P <i><on/off></i>	Enable PPPoE Service.
-u <i><username></i>	Set the username (max. 49 characters) for Internet accessing.
-p <i><password></i>	Set the password (max. 49 characters) for Internet accessing.
-a <i>n</i>	It means to set PPP Authentication Type and n means different types (represented by 0-1). n=0: PAP/CHAP (this is default setting) n=1: PAP Only
-t <i>n</i>	Set connection duration and n means different conditions. n=-1: Always-on n=1 ~ 999: Idle time for offline (default 180 seconds)
-i <i><ip address></i>	It means that <i>PPPoE server</i> will assign an IP address specified here for CPE (PPPoE client). If you type 0.0.0.0 as the <i><ip address></i> , ISP will assign suitable IP address for you. However, if you type an IP address here, the router will use that one as a fixed IP.
-w <i><ip address></i>	It means to assign WAN IP address for such connection. Please type an IP address here for WAN port.
-n <i><netmask></i>	It means to assign netmask for WAN connection. You have to type 255.255.255.xxx (x is changeable) as the netmask for WAN port.
-g <i><gateway></i>	Assign gateway IP for such WAN connection.
-s <i><server ip></i>	It means to set PPTP/L2TP Server IP. <i><server ip></i> = ppp.qqq.rrr.sss: PPTP/L2TP server IP
-A <i><idx></i>	It means to set Always On mode, and <i><idx></i> as backup WAN#.
-B <i><mode></i>	It means to set Backup mode. <i><mode></i> 0: When any WAN disconnect; 1: When all WAN disconnect.
-V	View Internet Access profile.

Example

```
>internet -M 1 -S tcom -u username -p password -a 0 -t -1 -i 0.0.0.0
WAN1 Internet Mode set to PPPoE/PPPoA
WAN1 ISP Name set to tcom
WAN1 Username set to username
WAN1 Password set successful
WAN1 PPP Authentication Type set to PAP/CHAP
WAN1 Idle timeout set to always-on
WAN1 Gateway IP set to 0.0.0.0
> internet -V
WAN1 Internet Mode:PPPoE
ISP Name: tcom
Username: username
Authentication: PAP/CHAP
Idle Timeout: -1
WAN IP: Dynamic IP
> internet -W 1 -M 1 -u link1 -p link1 -a 0
You are going to watching and setting in WAN 1
WAN1 Internet Mode set to PPPoE/PPPoA
WAN1 Username set to link1
WAN1 Password set successful
```

```
WAN1 PPP Authentication Type set to PAP/CHAP
>
```

Telnet Command: ip pubsubnet

This command allows users to enable or disable the IP routing subnet for your router.

Syntax

ip pubsubnet <Enable/Disable>

Syntax Description

Parameter	Description
<i>Enable</i>	Enable the function.
<i>Disable</i>	Disable the function.

Example

```
> ip 2ndsubnet enable
public subnet enabled!
```

Telnet Command: ip pubaddr

This command allows to set the IP routed subnet for the router.

Syntax

ip pubaddr ?

ip pubaddr <public subnet IP address>

Syntax Description

Parameter	Description
<i>?</i>	Display an IP address which allows users set as the public subnet IP address.
<i>public subnet IP address</i>	Specify an IP address. The system will set the one that you specified as the public subnet IP address.

Example

```
> ip pubaddr ?
% ip addr <public subnet IP address>
% Now: 192.168.0.1

> ip pubaddr 192.168.2.5
% Set public subnet IP address done !!!
```

Telnet Command: ip pubmask

This command allows users to set the mask for IP routed subnet of your router.

Syntax

ip pubmask ?

ip pubmask <public subnet mask>

Syntax Description

Parameter	Description
<i>?</i>	Display an IP address which allows users set as the public subnet mask.
<i>public subnet IP address</i>	Specify a subnet mask. The system will set the one that you specified as the public subnet mask.

Example

```
> ip pubmask ?
% ip pubmask <public subnet mask>
% Now: 255.255.255.0

> ip pubmask 255.255.0.0
% Set public subnet mask done !!!
```

Telnet Command: ip lanalias

This command is used for configuring LAN IP Alias.

Syntax

`ip lanalias <idx><option>`

Syntax Description

Parameter	Description
<i><idx></i>	It means the index number of the profile. Idx: 1 to 5
<i><option></i>	The available commands with parameters are listed below.
<i>-e <0/1></i>	It means to enable / disable the function of .. 0: disable 1: enable
<i>-a <IP address></i>	It means to set auxiliary IP address.
<i>-w n</i>	It means to add an address for the selected WAN interface (1 to 5). N=0, none N=1, means WAN1 N=2, means WAN2 ...
<i>-r</i>	Delete an existed WAN IP address.

Example

```
> ip lanalias 1 -a 192.168.1.56
>
```

Telnet Command: ip addr

This command allows users to set/add a specified LAN IP your router.

Syntax

`ip addr <IP address>`

Syntax Description

Parameter	Description
<i>IP address</i>	The LAN IP address.

Example

```
>ip addr 192.168.50.1
% Set IP address OK !!!
```



Info

When the LAN IP address is changed, the start IP address of DHCP server are still the same. To make the IP assignment of the DHCP server being consistent with this new IP address (they should be in the same network segment), the IP address of the PC must be fixed with the same LAN IP address (network segment) set by this command for accessing into the web user interface of the router. Later, modify the start addresses for the DHCP server.

Telnet Command: ip nmask

This command allows users to set/add a specified netmask for your router.

Syntax

```
ip nmask <IP netmask>
```

Syntax Description

Parameter	Description
<i>IP netmask</i>	The netmask of LAN IP.

Example

```
> ip nmask 255.255.0.0
% Set IP netmask OK !!!
```

Telnet Command: ip arp

ARP displays the matching condition for IP and MAC address.

Syntax

```
ip arp add <IP address> <MAC address> <LAN or WAN>
```

```
ip arp del <IP address><LAN or WAN>
```

```
ip arp flush
```

```
ip arp status
```

```
ip arp accept <0/1/2/3/4/5/6/7/status>
```

```
ip arp setCacheLife <time>
```

In which, **arp add** allows users to add a new IP address into the ARP table; **arp del** allows users to remove an IP address; **arp flush** allows users to clear arp cache; **arp status** allows users to review current status for the arp table; **arp accept** allows to accept or reject the source /destination MAC address; **arp setCacheLife** allows users to configure the duration in which ARP caches can be stored on the system. If **ip arp setCacheLife** is set with "60", it means you have an ARP cache at 0 second. Sixty seconds later without any ARP messages received, the

system will think such ARP cache is expired. The system will issue a few ARP request to see if this cache is still valid.

Syntax Description

Parameter	Description
<i>IP address</i>	It means the LAN IP address.
<i>MAC address</i>	It means the MAC address of your router.
<i>LAN or WAN</i>	It indicates the direction for the arp function.
<i>0/1/2/3/4/5/6/7</i>	0: disable to accept illegal source mac address 1: enable to accept illegal source mac address 2: disable to accept illegal dest mac address 3: enable to accept illegal dest mac address 4: Decline VRRP mac into arp table 5: accept VRRP mac into arp table 6: disable to accept the illegal source MAC address when ARP Request coming 7: enable to accept the illegal source MAC address when ARP Request coming status: display the setting status.
<i>Time</i>	Available settings will be 10, 20, 30,...2550 seconds.

Example

```
> ip arp add 192.168.100.100 AA:BB:CC:DD:EE:FF WAN S
> ip arp status
[ARP Table]

Index IP Address      MAC Address      HOST ID   Interface  VLAN   Port
  1   192.168.100.100AA-BB-CC-DD-EE-FF      WAN1      ---      --
  2   192.168.1.10   08-BF-B8-D5-DD-A9      LAN1      VLAN0    P9

> ip arp accept status

Accept illegal source mac arp: disable

Accept illegal dest mac arp: disable

Accept VRRP mac into arp table: disable

Accept illegal source mac arp when ARP Request Coming: enable
>
```

Telnet Command: ip dhcpc

This command is available for WAN DHCP.

Syntax

`ip dhcpc option`

`ip dhcpc option -h/l`

`ip dhcpc option -d [idx]`

`ip dhcpc option -e [1 or 0] -w [wan unumber] -c [option number] -v [option value]`

```

ip dhcpc option -e [1 or 0] -w [wan unumber] -c [option number] -x [option value]
ip dhcpc option -e [1 or 0] -w [wan unumber] -c [option number] -a [option value]
ip dhcpc option -u [idx unumber]
ip dhcpc release [wan number]
ip dhcpc renew [wan number]
ip dhcpc status

```

Syntax Description

Parameter	Description
<i>option</i>	It is an optional setting for DHCP server. -h: display usage -l: list all custom set DHCP options -a: set option value by address list -c: set option number: 0-255 -d: delete custom dhcp client option by index number -e: enable/disable option feature, 1:enable, 0:disable -u: update by index number -v: set option value by string -w: set WAN number (e.g., 1=WAN1) -x: set option value by raw byte (hex) -r: remove all customized CHCP client option
<i>release</i>	It means to release current WAN IP address.
<i>renew</i>	It means to renew the WAN IP address and obtain another new one.
<i>status</i>	It displays current status of DHCP client.

Example

```

> ip dhcpc option -e 1 -w 1/2 -c 18 -v /path1
> ip dhcpc option -e 0 -w 2/6/7 -c 18 -x 2f70617468
% DHCP client option number and wan settings are duplicate!

> ip dhcpc option -e 0 -w 3/6/7 -c 18 -x 2f70617468
> ip dhcpc status
=====
WAN1:

DHCP Client Status: None active DHCP client!

=====
WAN2:

DHCP Client Status: None active DHCP client!

=====
...
...
...
...
=====
WAN52: <Virtual WAN>

DHCP Client Status: None active DHCP client!

```

Telnet Command: ip ping

This command allows users to ping IP address of WAN1/WAN2 for verifying if the WAN connection is OK or not.

Syntax

ip ping <IP address> <AUTO/WAN1/WAN2><Source IP Address>

Syntax Description

Parameter	Description
<i>IP address</i>	It means the WAN IP address.
<i>AUTO/WAN1/WAN2</i>	It means the WAN port that the above IP address passes through.

Example

```
>ip ping 172.16.3.229 WAN1
Pinging 172.16.3.229 with 64 bytes of Data:
Receive reply from 172.16.3.229, time=0ms
Receive reply from 172.16.3.229, time=0ms
Receive reply from 172.16.3.229, time=0ms
Packets: Sent = 5, Received = 5, Lost = 0 <0% loss>
>
```

Telnet Command: ip tracet

This command allows users to trace the routes from the router to the host.

Syntax

ip tracet <Host/IP address> <WAN1/WAN2/WAN3/WAN4/WAN5/WAN6/WAN7/WAN8/
WAN9/WAN10/WAN11/WAN12> <Udp/Icmp>

Syntax Description

Parameter	Description
<i>IP address</i>	The target IP address.
<i>WAN1 - WAN12</i>	It means the WAN port that the above IP address passes through.
<i>Udp/Icmp</i>	The UDP or ICMP.

Example

```
>ip tracet 22.128.2.62 WAN1
Traceroute to 22.128.2.62, 30 hops max
 1  172.16.3.7  10ms
 2  172.16.1.2  10ms
 3  Request Time out.
 4  168.95.90.66  50ms
 5  211.22.38.134  50ms
 6  220.128.2.62  50ms
Trace complete
```

Telnet Command: ip telnet

This command allows users to access specified device by telnet.

Syntax

ip telnet [*IP address*][*Port*]

Syntax Description

Parameter	Description
<i>IP address</i>	Type the WAN or LAN IP address of the remote device.
<i>Port</i>	Type a port number (e.g., 23). Available settings: 0 ~65535.

Example

```
> ip telnet 172.17.3.252 23
>
```

Telnet Command: ip rip

This command allows users to set the RIP (routing information protocol) of IP.

Syntax

`ip rip <0/1/2>`

Syntax Description

Parameter	Description
<i>0/1/2</i>	0 means disable; 1 means LAN1 and 2 means IP Routed.

Example

```
> ip rip 1
%% Set RIP LAN1.
```

Telnet Command: ip wanrip

This command allows users to set the RIP (routing information protocol) of WAN IP.

Syntax

`ip wanrip [ifno] -e [0/1]`

Syntax Description

Parameter	Description
<i>ifno</i>	It means the connection interface. WAN#: WAN1/WAN2/WAN3/WAN4/WAN5/WAN6/WAN7/ WAN8/WAN9/WAN10/WAN11/WAN1 3: PVC3, 4: PVC4, 5: PVC5 Note: PVC3 ~PVC5 are virtual WANs.
<i>-e</i>	It means to disable or enable RIP setting for specified WAN interface. 1: Enable the function of setting RIP of WAN IP. 0: Disable the function.

Example

```

> ip wanrip 5 -e 1
> ip wanrip ?
% ip tracert <Host/IP address>
<WAN1/WAN2/WAN3/WAN4/WAN5/WAN6/WAN7/WAN8/WAN9/WAN10/WAN11/WAN1
3: PVC3,4: PVC4,5: PVC5
-e <0/1> 0: disable, 1: enable
Now status:
WAN[1] Rip Protocol disable
WAN[2] Rip Protocol disable
WAN[3] Rip Protocol disable
WAN[4] Rip Protocol disable
WAN[5] Rip Protocol enable
...
...
...
WAN[52] Rip Protocol enable
>

```

Telnet Command: ip route

This command allows users to set static route.

Syntax

ip route add <dst> <netmask> <gateway> <ifno> <rtype>

ip route del <dst> <netmask><rtype>

ip route status

ip route cnc

ip route tel

ip route default <add/del/off/?>

ip route clean <1/0>

Syntax Description

Parameter	Description
<i>add</i>	It means to add an IP address as static route.
<i>del</i>	It means to delete specified IP address.
<i>status</i>	It means current status of static route.
<i>dst</i>	It means the IP address of the destination.
<i>netmask</i>	It means the netmask of the specified IP address.
<i>gateway</i>	It means the gateway of the connected router.
<i>ifno</i>	It means the connection interface. 3=WAN1 4=WAN2 5=WAN3 6=WAN4 7=WAN5 8=WAN6 9=WAN7 10=WAN8 11=WAN9 12=WAN10
<i>rtype</i>	It means the type of the route. default : default route; static: static route.
<i>cnc</i>	It means current IP range for CNC Network.
<i>tel</i>	It means to display current IP range for China Telecom Network.

default	It is obsolete for NAT subnet only use route policy instead. add/del: To modify default route, "ip route del 0.0.0.0" and "ip route add 0.0.0.0 interface". off: ip route default off.
clean	Clean all of the route settings. 1: Enable the function. 0: Disable the function.

Example

```
> ip route add 172.16.2.0 255.255.255.0 172.16.2.4 3 static
> ip route status

Codes: C - connected, S - static, R - RIP, * - default, ~ - private,
B - BGP
C~      192.168.1.0/    255.255.255.0 is directly connected, LAN1
S       172.16.2.0/    255.255.255.0 via 172.16.2.4, WAN1
>
```

Telnet Command: ip igmp_proxy

This command allows users to enable/disable igmp proxy server.

Syntax

```
ip igmp_proxy set
ip igmp_proxy reset
ip igmp_proxy wan
ip igmp_proxy query <value>
ip igmp_proxy ppp <0/1>
ip igmp_proxy status
ip igmp_proxy version
ip igmp_proxy syslog
```

Syntax Description

Parameter	Description
<i>set</i>	It means to enable proxy server.
<i>reset</i>	It means to disable proxy server.
<i>wan</i>	It means to specify WAN interface for IGMP service.
<i>query <value></i>	It means to set IGMP general query interval. The default value is 125000 ms.
<i>ppp <0/1></i>	0 - No need to set IGMP with PPP header. 1 - Set IGMP with PPP header.
<i>status</i>	It means to display current status for proxy server.
<i>version <v2, v3, auto, show></i>	It means to specify the IGMP version. v2, v3, auto, show
<i>syslog <0/1></i>	Make IGMP log be recorded on syslog. 0: disable 1: enable

Example

```
> ip igmp_proxy set
% ip igmp_proxy [set|reset|wan|status], IGMP Proxy is ON
> ip igmp_proxy status
%% ip igmp_proxy [set|reset|wan|status], IGMP Proxy is ON
%%% igmp_proxy WAN:
    224.0.0.251      state=1
    239.255.255.250 state=1
    224.0.0.252      state=1
    224.0.0.251      timer=0
    239.255.255.250 timer=0
    224.0.0.252      timer=0
```

Telnet Command: ip igmp_snoop

This command is used to enable/disable igmp snoop server.

Syntax

```
ip igmp_snoop enable
ip igmp_snoop disable
ip igmp_snoop status
ip igmp_snoop table
ip igmp_snoop txquery <on/off><v2/v3>
ip igmp_snoop mode <hw/sw>
ip igmp_snoop chkleave <on/off>
ip igmp_snoop separate <on/off>
ip igmp_snoop portchk <on/off>
ip igmp_snoop acceptlist <type><index>
```

Syntax Description

Parameter	Description
<i>enable</i>	It means to enable proxy server.
<i>disable</i>	It means to disable proxy server.
<i>status</i>	It means to display current status for proxy server.
<i>table</i>	It means to display the whole table of IGMP Snoop configuration.
<i>txquery</i> <on/off><v2/v3>	It means to send out IGMP QUERY to LAN periodically. On: enable Off: disable v2: version v2 v3: version v3
<i>mode</i> <hw/sw>	Make IGMP snooping work on software or hardware.
<i>chkleave</i> <on/off>	It means checking the leave status. On: enable the IGMP snoop leave checking function. Off: it will drop LEAVE if still clients on the same group.
<i>separate</i> <on/off>	On - IGMP packets will be separated by NAT/Bridge mode. It means to set IGMP packets being separated by NAT/Bridge.

	On: The packets will be separated. Off: The packets will not be separated by NAT/Bridge.
<i>acceptlist <type><index></i>	Type: Enter 0 (disable), 1 (ip object) or 2 (ip group). Index: Enter 0 to 500 (for ip object); enter 0 to 32 (for ip group).

Example

```
> ip igmp_snoop mode sw
  igmp snooping works on SW mode now.
ip igmp_snoop enable
%% ip igmp snooping [enable|disable|status], IGMP Snooping is Enabled.
>
```

Telnet Command: ip session

This command allows users to set maximum session limit number for the specified IP; set message for exceeding session limit and set how many seconds the IP session block works.

Syntax

```
ip session on
ip session off
ip session default <num>
ip session defaultp2p <num>
ip session status
ip session show
ip session timer <num>
ip session <block/unblock><IP>
ip session <add/del><IP1-IP2> <num> <p2pnum>
```

Syntax Description

Parameter	Description
<i>on</i>	Turn on session limit for each IP.
<i>off</i>	Turn off session limit for each IP.
<i>default<num></i>	Set the default number of session num limit.
<i>defaultp2p <num></i>	Set the default number of session num limit for p2p.
<i>status</i>	Display the current settings.
<i>show</i>	Display all session limit settings in the IP range.
<i>timer <num></i>	Set when the IP session block works. The unit is second.
<i><block/unblock><IP></i>	Block/unblock the specified IP address. Block: The IP cannot access Internet through the router. Unblock: The specified IP can access Internet through the router.
<i><add/del><IP1-IP2> <num> <p2pnum></i>	add/del: Add or delete the session limits in an IP range. IP1-IP2 - It means the range of IP address specified for this command. num - It means the number of the session limits, e.g., 100. p2pnum - It means the number of the session limits, e.g., 50 for P2P.

Example

```
> ip session default 100
> ip session add 192.168.1.5-192.168.1.100 100 50
> ip session on
> ip session status

IP range:
 192.168.1.5 - 192.168.1.100 : 100

Current ip session limit is turn on

Current default session number is 100
>
```

Telnet Command: ip bandwidth

This command allows users to set maximum bandwidth limit number for the specified IP.

Syntax

`ip bandwidth on`

`ip bandwidth off`

`ip bandwidth default <tx_rate><rx_rate>`

`ip bandwidth status`

`ip bandwidth show`

`ip bandwidth routing <on/off>`

`ip bandwidth schedule <s1> <s2> <s3> <s4>`

`ip bandwidth <add/del> <IP1-IP2> <tx> <rx> <shared>`

Syntax Description

Parameter	Description
<i>on</i>	It means to turn on the IP bandwidth limit.
<i>off</i>	It means to turn off the IP bandwidth limit.
<i>default</i> <tx_rate><rx_rate>	It means to set default tx and rx rate of bandwidth limit. The range is from 0-30000 Kbps/Mbps
<i>status</i>	It means to display the current settings.
<i>show</i>	It means to display all the bandwidth limits settings within the IP range.
<i>routing</i> <on/off>	on/off: Apply (on) or not apply (off) to the IP Routed Subnet.
<i>schedule</i> <s1> <s2> <s3> <s4>	Set the schedule profile. <s1> <s2> <s3> <s4>: Specify the profile index number. Up to four profiles can be set at one time. Available profiles numbers range from 1 to 16.
<add/del> <IP1-IP2> <tx> <rx> <shared>	Add/del: Add or delete the bandwidth within the IP range. IP1-IP2: Set the range of IP address specified for this command. tx: Set transmission rate for bandwidth limit. rx: set receiving rate for bandwidth limit. shared: the bandwidth will be shared for the IP range.

Example

```

> ip bandwidth default 200 800
> ip bandwidth add 192.168.1.50-192.168.1.100 10 60
> ip bandwidth status

IP range:
  192.168.1.50 - 192.168.1.100 : Tx:10K Rx:60K

Current ip Bandwidth limit is turn off

Auto adjustment is off

```

Telnet Command: ip dataflowmonitor

This command allows users to set data flow monitor.

Syntax

```

ip dataflowmonitor on
ip dataflowmonitor off
ip dataflowmonitor status

```

Syntax Description

Parameter	Description
<i>on</i>	It means to enable the Data Flow Monitor function.
<i>off</i>	It means to disable the Data Flow Monitor function.
<i>show</i>	It means to display current status of Data Flow Monitor function.

Example

```

> ip dataflowmonitor status
Data Flow Monitor: On

```

Telnet Command: ip bindmac

This command allows users to set IP-MAC binding for LAN host.

Syntax

```

ip bindmac on
ip bindmac off
ip bindmac strict_on
ip bindmac strict_off
ip bindmac add <IP> <MAC> <Comment>
ip bindmac del <IP/all>
ip bindmac subnet <all/set LAN_Index/unset LAN_Index/clear/show>
ip bindmac show

```

Syntax Description

Parameter	Description
<i>on</i>	It means to turn on IP bandmac policy. Even the IP is not in the

	policy table, it can still access into network.
<i>off</i>	It means to turn off all the bindmac policy.
<i>strict_on</i>	It means that only those IP address in IP bindmac policy table can access into network.
<i>strict_off</i>	It means to turn off IP bindmac policy and only those IP can access network.
<i>add <IP> <MAC> <Comment></i>	It means to add one ip bindmac. <IP>: Enter the IP address for binding with specified MAC address. <MAC>: Enter the MAC address for binding with the IP address specified. <Comment>: Enter words as a brief description.
<i>del <IP/all></i>	It means to delete one IP bindmac. <IP>: Enter the IP address for binding with specified MAC address. <all>: It means to delete all the IP bindmac settings.
<i>subnet <all/set LAN_Index/unset LAN_Index/clear/show></i>	It means to set the LAN subnet(s) for applying the rules of Bind IP to MAC all: Make all LAN subnets apply for the rules. set <LAN_Index>: Specify certain LAN subnet, e.g., set LAN2. unset <LAN_Index>: Remove certain LAN subnet by specifying the index number of LAN port, e.g., unset LAN3. clear: Remove all LAN subnets. show: Display current LAN subnet settings.
<i>show</i>	It means to display the IP address and MAC address of the pair of binded one.

Example

```

> ip bindmac add 192.168.1.46 00:50:7f:22:33:55 just for test
> ip bindmac show
ip bind mac function is turned OFF
ip bind mac function is STRICT OFF
Show all IP Bind MAC entries.
IP : 192.168.1.46 bind MAC : 00-50-7f-22-33-55 HOST ID :
Comment : just
>

```

Telnet Command: ip bgp

This command allows users to configure settings for BGP.

Syntax

```

ip bgp mode <0/1>
ip bgp as <0-4294967295>
ip bgp hold <10-65535>
ip bgp retry <3-255 >
ip bgp id <x.x.x.x>
ip bgp show

```

```

ip bgp neighbor <idx> mode <0/1>
ip bgp neighbor <idx> name <max len>
ip bgp neighbor <idx> ip <x.x.x.x>
ip bgp neighbor <idx> as <1-4294967295>
ip bgp neighbor <idx> weight <0-7>
ip bgp neighbor <idx> prepend <0-7>
ip bgp neighbor <idx> md5 <0/1>
ip bgp neighbor <idx> key <max len>
ip bgp neighbor <idx> show
ip bgp neighbor show all
ip bgp static <sid> <ip> <netmask>
ip bgp static <sid> delete
ip bgp static show

```

Syntax Description

Parameter	Description
<i>mode</i> <0/1>	Enable or disable the GMP. 0: disable 1: enable
<i>as</i> <0-4294967295>	Set the AS number for local router. <0-4294967295>
<i>hold</i> <10-65535>	Set the time interval (in seconds) to determine the peer is dead when the router is unable to receive any keepalive message from the peer within the time. <10-65535>: Default is 180 sec.
<i>retry</i> <3-255>	Set the BGP conntion retry time. <3-255>: Default is 120 sec
<i>id</i> <x.x.x.x>	Select a enabled local subnet IP as router ID. <x.x.x.x>: Enter an IP address.
<i>show</i>	Display all BGP settings.
<i>neighbor</i> <idx> <i>mode</i> <0/1>	Enable or disable the neighbor profile. <idx>: 1 to 8. Index number of the neighbor profile. 0: disable 1: enable
<i>neighbor</i> <idx> <i>name</i> <max len>	Set a name of the neighbor profile. <idx>: 1 to 8. Index number of the neighbor profile. <max len>: Enter a name (no more than 20 characters).
<i>neighbor</i> <idx> <i>ip</i> <x.x.x.x>	Set the IP address for the specified neighbor profile. <idx>: 1 to 8. Index number of the neighbor profile. <x.x.x.x>: Enter an IP address (e.g., 192.168.1.33).
<i>neighbor</i> <idx> <i>as</i> <1-4294967295>	Set an AS number for the specified neighbor profile. <idx>: 1 to 8. Index number of the profile. <1-4294967295>: Enter a number.

<i>neighbor <idx> weight <0-7></i>	Set the weight value for the specified neighbor profile. <idx>: 1 to 8. Index number of the neighbor profile. <0-7>: higher is better.
<i>neighbor <idx> prepend <0-7></i>	Set the prepend value for the specified neighbor profile. <idx>: 1 to 8. Index number of the neighbor profile. <0-7>: lower is better.
<i>neighbor <idx> md5 <0/1></i>	Enable or disable the MD5 authentication for the neighbor profile. <idx>: 1 to 8. Index number of the profile. 0: Disable. 1: Enable.
<i>neighbor <idx> key <max len></i>	Set the key used for the MD5 authentication. <idx>: 1 to 8. Index number of the neighbor profile. <max len>: Enter a name (no more than 20 characters).
<i>neighbor <idx> show</i>	Display the BGP setting for the specified neighbor profile. <idx>: 1 to 8. Index number of the profile.
<i>neighbor show all</i>	Display the BGP setting of neighbor profiles.
<i>static <sid> <ip> <netmask></i>	Set the IP address and subnet mask for specified static network profile. <sid>: 1 to 16. Index number of the static network profile. <ip>: Enter an IP address. <netmask>: Enter a netmask.
<i>static <sid> delete</i>	Remove / clear the settings for the selected static network profile. <sid>: 1 to 16 Index number of the profile.
<i>static show</i>	Display the BGP setting of static network profiles.

Example

```

> ip bgp static 1 192.168.2.56 255.255.255.0
Set static network index: 1
IP addr: 192.168.2.56
Net mask: 255.255.255.0
> ip bgp static show
BGP is disable
Local autonomous system number: 0
Hold time: 180
Connect retry time: 120
Router ID: 192.168.1.1

BGP neighbor:
Idx Mode As Number Name IP Addr Status weight prepend
-----
1 Dis 0 Empty None 0 0
2 Dis 0 Empty None 0 0
3 Dis 0 Empty None 0 0
4 Dis 0 Empty None 0 0
5 Dis 0 Empty None 0 0
6 Dis 0 Empty None 0 0
...
...

```

```

...
63 Dis 0          Empty      None      0      0
64 Dis 0          Empty      None      0      0

BGP static networks:
>

```

Telnet Command: ip ospf

Users could use this command to configure OSPF (Open Shortest Path First) setting.

Syntax

```

ip ospf en
ip ospf dis
ip ospf status
ip ospf cfg show
ip ospf cfg set <idx> state <dis/en>
ip ospf cfg set <idx> area <value>
ip ospf cfg set <idx> lan <value>
ip ospf cfg set <idx> wan <value>
ip ospf nbr

```

Syntax Description

Parameter	Description
<i>en</i>	Enable the function of Open Short Path First.
<i>dis</i>	Disable the function of Open Short Path First.
<i>status</i>	Display interface status.
<i>cfg show</i>	Display configuration setting for all interfaces.
<i>cfg set <idx> state <dis/en></i>	Enable or disable the interface (LAN/WAN) setting. <idx>: 1 to 64. <dis/en>: disable or enable.
<i>cfg set <idx> area <value></i>	Set interface for area id: <idx>: 1 to 64. <value>: 1 to 2147483647.
<i>cfg set <idx> lan <value></i>	Set interface for LAN. <idx>: 1 to 64. <value>: 1 to 20.
<i>cfg set <idx> wan <value></i>	Set interface for WAN. <idx>: 1 to 64. <value>: 1 to 2.
<i>nbr</i>	Display interface neighbors.

Example

```

> ip ospf cfg set 1 state en
> ip ospf cfg set 1 area 100
> ip ospf cfg set 1 wan 1
> ip ospf cfg show

```

```

OSPF: Enable
-----
  Idx  State  Area_id  Interface  Auth  Key ID
    0   En    100      WAN_1     Dis   0
    1   Dis    0        LAN_1     Dis   0
    2   Dis    0        LAN_1     Dis   0
...
...
>

```

Telnet Command: ip maxnouser

This command is used to set the maximum number of NAT users.

Syntax

`ip maxnouser user no`

Syntax Description

Parameter	Description
<i>User no</i>	A number specified here means the total NAT users that Vigor router supports. 0 - It means no limitation.

Example

```

> ip maxnouser 100
% Max NAT user = 100

```

Telnet Command: ip policy_rt

This command is used to set the IP policy route profile.

Syntax

`ip policy_rt [-<command> <parameter> | ...]`

Syntax Description

Parameter	Description
<code><command><parameter> ...]</code>	The available commands with parameters are listed below. [...] means that you can Enter several commands in one line.
General Setup for Policy Route	
<code>-i <value></code>	Specify an index number for setting policy route profile. Value: 1 to 60. "-1" means to get a free policy index automatically.
<code>-e <0/1></code>	0: Disable the selected policy route profile. 1: Enable the selected policy route profile.
<code>-o <value></code>	Determine the operation of the policy route. Value: add - Create a new policy route profile. del - Remove an existed policy route profile.

	edit - Modify an existed policy route profile. flush - Reset policy route to default setting.
-1 <any/range>	Specify the source IP mode. Range: Indicate a range of IP addresses. Any: It means any IP address will be treated as source IP address.
-2 <any/ip_range/ip_subnet/domain>	Specify the destination IP mode. Any: No need to specify an IP address for any IP address will be treated as destination IP address. ip_range: Indicates a range of IP addresses. ip_subnet: Indicates the IP subnet. domain: Indicates the domain name.
-3 <any/range>	Specify the destination port mode. Range: Indicate a range of port number. Any: It means any port number can be used as destination port.
-G <default/specific>	Specify the gateway mode.
-L <default/specific>	Specify the failover gateway mode.
-s <value>	Indicate the source IP start. Value: The type format shall be "xxx.xxx.xxx.xxx". (e.g, 192.168.1.0)
-S <value>	Indicate the source IP end. Value: The type format shall be "xxx.xxx.xxx.xxx". (e.g, 192.168.1.100)
-d <value>	Indicate the destination IP start. Value: The type format shall be "xxx.xxx.xxx.xxx". (e.g, 192.168.2.0)
-D <value>	Indicate the destination IP end. Value: The type format shall be "xxx.xxx.xxx.xxx". (e.g, 192.168.2.100)
-p <value>	Indicate the destination port start. Value: Type a number (1 ~ 65535) as the port start (e.g., 1000).
-P <value>	Indicate the destination port end. Value: Type a number (1 ~ 65535) as the port end (e.g., 2000).
-y <value>	Indicate the priority of the policy route profile. Value: Type a number (0 ~ 250). The default value is "150".
-I <value>	Indicate the interface specified for the policy route profile. Value: Available interfaces include, LAN1 ~ LAN100, IP_Routed_Subnet, VOIP_WAN, WAN1 ~ WAN12, VPN_PROFILE_1 ~ VPN_PROFILE_500, WAN_1_IP_ALIAS_1 ~ WAN_10_IP_ALIAS_300
-g <value>	Indicate the gateway IP address. Value: The type format shall be "xxx.xxx.xxx.xxx". (e.g, 192.168.3.1)
-l <value>	Indicate the failover IP address.

	Value: The type format shall be "xxx.xxx.xxx.xxx". (e.g, 192.168.4.1)
<i>-t <value></i>	It means "protocol". Value: Available settings include "TCP", "UDP", "TCP/UDP", "ICMP" and "Any".
<i>-n <0/1></i>	Indicates the function of "Force NAT". 0: Disable the function. 1: Enable the function.
<i>-F [value]</i>	It means "enable failover by MOS". value: 0 or 1
<i>-M [value]</i>	It means "Value of failover MOS". value: 2.0 ~ 4.0
<i>-a <0/1></i>	Indicates to enable the function of failover. 0: Disable the function. 1: Enable the function.
<i>-f <value></i>	It means to specify the interface for failover. Value: Available interfaces include, NO_FAILOVER, Default_WAN, Policy1 ~ Policy250 LAN1 ~ LAN100 IP_Routed_Subnet, WAN1 ~ WAN12, VPN_PROFILE_1 ~ VPN_PROFILE_500, WAN_1_IP_ALIAS_1 ~ WAN_4_IP_ALIAS_300
<i>-b <value></i>	It means "failback". Value: Available settings include, 0: Disable the function of "failback". 1: Enable the function of "failback".
<i>-v</i>	View current failback setting.
Diagnose for Policy Route	
<i>-s <value></i>	It means "source IP". Value: Available settings include: Any: It indicates any IP address can be used as source IP address. "xxx.xxx.xxx.xxx": The type format (e.g, 192.168.1.0).
<i>-d <value></i>	It means "destination IP". Value : Available settings include: Any: It indicates any IP address can be used as destination IP address. "xxx.xxx.xxx.xxx": Specify an IP address.
<i>-p <value></i>	It means "destination port". Value: Specify a number or type Any (indicating any number).
<i>-t <value></i>	It means "protocol". Value: Available settings include "ICMP", "TCP", "UDP" and "Any".

Example

```

> ip policy_rt diagnose -s 192.168.1.100 -d any -p any -t ICMP

-----
      Matched Route (Priority)
-----
* No_Match

-----
      Matched Policy (Priority)
-----
* Policy_1 (200)

* Conclusion:The packet was dropped because the send-to interface of the mat
ched policy "policy 1" was inactive and there was no failover setting
> ip policy_rt -i -1 -o add -l range -s 192.168.1.10 -S 192.168.1.20 -2
ip_range -d 202.211.100.10 -D 202.211.100.20 -g 202.211.100.1 -I WAN2
>

```

Telnet Command: ip lanDNSRes

This command is used to set LAN DNS profiles. With such feature, the user can configure some services (such as ftp, www or database) with domain name which is easy to be accessed.

Syntax

ip lanDNSRes [-<command> <parameter> | ...]

Syntax Description

Parameter	Description
<command><parameter>[...]	The available commands with parameters are listed below. [...] means that you can type in several commands in one line.
-a <IP Address>	It is used to configure IP address mapping (IPv4/IPv6 Address or multiple subnet addresses). IP Address: type the IP address (e.g., 192.168.1.56).
-c <CNAME>	It is used to set CNAME. CNAME: Enter a string.
-d <address mapping index number>	It means to delete index number with address mapping configured. Address mapping index number : type the index number which represents the address mapping profile.
-e <0/1>	It means to enable or disable the function of LAN DNS or DNS Forwarding Profile. 0: disable 1: enable
-l <profile setting index number>	It means to create LAN DNS profile with specified domain name. profile setting index number : type the index number which represents the profile with domain name configured.
-l	List the content of LAN DNS profile (including domain name, IP address and message).
-n <domain name>	Set domain name.
-p <profile name>	Set profile name for LAN DNS.
-r	Reset the settings for selected profile.
-R	It means to set to factory default setting.

-s <0/1>	0:reply all 1:reply only same subnet packet.
-z	Update LAN DNS config to DNS Cache.

Example

```
>ip lanDNSRes -i 1 -p test
% Configure Set1's Profile:test
> ip lanDNSRes -i 1 -l
% Idx: 1
% State: Disable
% Profile: test
% Domain Name:
% ----- Address Mapping Table -----
% Not Set Address Mapping.
>
```

Telnet Command: ip dnsforward

This command is used to set LAN DNS profile for conditional DNS forwarding.

Syntax

ip dnsforward [*-<command>* <parameter> | ...]

Syntax Description

Parameter	Description
[<command><parameter> ...]	The available commands with parameters are listed below. [...] means that you can type in several commands in one line.
-a <IP Address>	Set forwarded DNS server IP Address.
-d <DNS server mapping index number>	Delete the selected LAN DNS profile.
-e <0/1>	0: disable such function. 1: enable such function.
-i <profile setting index number>	Type the index number of the profile.
-l	List the content of LAN DNS profile (including domain name, IP address and message).
-n <domain name>	Set domain name.
-p <profile name>	Set profile name for LAN DNS.
-r	Reset the settings for selected profile.
-R	Set to factory default settings.

Example

```
> ip dnsforward -i 1 -n ftp.drayTek.com
% Configure Set1's DomainName:ftp.drayTek.com
> ip dnsforward -i 1 -a 172.16.1.1
% Configure Set1's IP:172.16.1.1
```

```

> ip dnsforward -i 1 -1
% Idx: 1
% State: Disable
% Profile: test
% Domain Name: ftp.drayTek.com
% DNS Server IP: 172.16.1.1
>

```

Telnet Command: ip spoofdef

This command is used to enable/disable the IP Spoofing Defense.

Syntax

```
ip spoofdef <WAN/LAN><0/1>
```

Syntax Description

Parameter	Description
[<command> <parameter> ...]	The available commands with parameters are listed below. [...] means that you can Enter several commands in one line.
<WAN/LAN>	It means to block IP packet from WAN/LAN with inconsistent source IP address.
<0/1>	0: Disable the function. 1: Enable the funciton.

Example

```

> ip spoofdef WAN 0
% Setting saved:
> ip spoofdef LAN 1
Setting saved:
> ip spoof def ?
Invalid Paremeter
IP Spoofing Defense Usage:
Set IP Spoofing Defense: spoofdef <WAN/LAN> <0/1>
Ex: "spoofdef WAN 1" to block IP packet from WAN with inconsistent source
IP add
ress
Current setting:
Block IP packet from WAN with inconsistent source IP address : Disable
Block IP packet from LAN with inconsistent source IP address : Enable
>

```

Telnet Command: ip6 addr

This command allows users to set the IPv6 address for your router.

Syntax

```

ip6 addr -s <prefix> <prefix-length> <LAN1/..LAN100/ WAN1/..WAN10/VPN1/..VPN500>
ip6 addr -d <prefix> <prefix-length> <LAN1/..LAN100/ WAN1/..WAN10/VPN1/..VPN500>
ip6 addr -a <LAN1/..LAN100/ WAN1/..WAN10/VPN1/..VPN500> -u
ip6 addr -v <LAN1/..LAN100/ WAN1/..WAN10 >

```

ip6 addr -t <old-prefix><old-prefix-length><new-prefix> <new-prefix-length>
<LAN1/..LAN100/ WAN1/..WAN10 >

ip6 addr -o <1/2>

ip6 addr -o 3 <prefix> <prefix-length> <WAN1/..WAN10 >

ip6 addr -l <prefix> <prefix-length> <LAN1/..LAN100>

ip6 addr <-p/-b> <prefix> <prefix-length> <WAN1/..WAN10 >

ip6 addr -x <LAN1/..LAN100 >

ip6 addr -c <LAN1/..LAN100>

ip6 addr -e <type> < LAN1/..LAN100>

Syntax Description

Parameter	Description
-s <prefix> <prefix-length> <LAN1/..LAN100/ WAN1/..WAN10/ VPN1/..VPN500>	It means to add a static ipv6 address. <prefix>: It means to enter the prefix number of IPv6 address. <prefix-length>: It means to enter a fixed value as the length of the prefix. <LAN1/..LAN100/ WAN1/..WAN10/VPN1/..VPN500>: It means to specify LAN/WAN/VPN interface for such address.
-d <prefix> <prefix-length> <LAN1/..LAN100/ WAN1/..WAN10/ VPN1/..VPN500>	It means to delete an ipv6 address. <prefix>: It means to enter the prefix number of IPv6 address. <prefix-length>: It means to enter a fixed value as the length of the prefix. <LAN1/..LAN100/ WAN1/..WAN10/VPN1/..VPN500>: It means to specify LAN/WAN/VPN interface for such address.
-a <LAN1/..LAN100/ WAN1/..WAN10/ /VPN1/..VPN500> -u	It means to show current address(es) status. <LAN1/..LAN100/ WAN1/..WAN10/VPN1/..VPN500>: It means to specify LAN/WAN/VPN interface. <-u>: It means to show unicast address only.
-v <LAN1/..LAN100/ WAN1/..WAN10 >	It means to show prefix list status.
-t <old-prefix><old-prefix-length><new-prefix> <new-prefix-length> < LAN1/..LAN100/ WAN1/..WAN10 >	It means to update WAN static IPv6 address table. <old-prefix>: It means to enter the prefix number of IPv6 address. <old prefix-length>: It means to enter a fixed value as the length of the prefix. <new-prefix>: It means to enter the prefix number of IPv6 address. <new-prefix-length>: It means to enter a fixed value as the length of the prefix. <LAN1/..LAN100/ WAN1/..WAN10>: It means to specify LAN/WAN/USB interface for such address.
-o <1/2>	<1>: It means to show old prefix list. <2>: It means to send old prefix option by RA.
-o <3> <prefix> <prefix-length> < WAN1/..WAN10 >	<3>: It means to set old prefix. <prefix>: It means to enter the prefix number of IPv6 address.

	<p><prefix-length>: It means to enter a fixed value as the length of the prefix.</p> <p><WAN1/..WAN10>: It means to specify a WAN interface for such address.</p>
<p><i>-l</i> <prefix> <prefix-length> <LAN1/..LAN100></p>	<p>It means to add a ULA.</p> <p><prefix>: It means to enter the prefix number of IPv6 address.</p> <p><prefix-length>: It means to enter a fixed value as the length of the prefix.</p> <p><LAN1/..LAN100>: It means to specify a LAN interface for such address.</p>
<p><i>-p/-b</i> <prefix> <prefix-length> <WAN1/..WAN10></p>	<p>It means to add/delete an prefix to/from prefix list.</p> <p>p: Add a prefix to a prefix list.</p> <p>b: Delete a prefix from a prefix list.</p> <p><prefix>: It means to enter the prefix number of IPv6 address.</p> <p><prefix-length>: It means to enter a fixed value as the length of the prefix.</p> <p><WAN1/..WAN10>: It means to specify a WAN interface for such address.</p>
<p><i>-x</i> <LAN1/..LAN100></p>	<p>It means to generate a ULA automatically.</p> <p><LAN1/..LAN100>: It means to specify a LAN interface.</p>
<p><i>-c</i> <LAN1/..LAN100></p>	<p>It means to delete a ULA .</p> <p><LAN1/..LAN100>: It means to specify a LAN interface.</p>
<p><i>-e</i> <type> <LAN1/..LAN100></p>	<p>It means to set ULA type.</p> <p><type>: 0, disable; 1, static; 2, auto</p> <p><LAN1/..LAN100>: It means to specify a LAN interface.</p>

Example

```

> ip6 addr -a
DMZ
Unicast Address:
FE80::21D:AAFF:FE4B:3E80/64 (Link)
Multicast Address:
FF02::1:FF00:0
FF02::1:FF4B:3E80
FF02::1
LAN100
Unicast Address:
FE80::21D:AAFF:FE4B:3E80/64 (Link)
Multicast Address:
FF02::1:FF00:0
FF02::1:FF4B:3E80
FF02::1
LAN99
Unicast Address:
FE80::21D:AAFF:FE4B:3E80/64 (Link)
Multicast Address:
FF02::1:FF00:0
FF02::1:FF4B:3E80
FF02::1

```

```

LAN98
Unicast Address:

FE80::21D:AAFF:FE4B:3E80/64 (Link)
--- MORE ---  ['q': Quit, 'Enter': New Lines, 'Space Bar': Next Page] ---

```

Telnet Command: ip6 dhcp req_opt

This command is used to configure option-request settings for DHCPv6 client.

Syntax

```
ip6 dhcp req_opt <LAN1|...|LAN100|WAN1|...|WAN10> [-<command> <parameter>| ... ]
```

Syntax Description

Parameter	Description
<i>req_opt</i>	It means option-request.
<LAN1 LAN2 ... LAN100 WAN1 ... WAN10 >	It means to specify LAN or WAN interface for such address.
<command><parameter> ...]	The available commands with parameters are listed below. [...] means that you can type in several commands in one line.
-a	It means to show current DHCPv6 status.
-s	It means to ask the SIP.
-S	It means to ask the SIP name.
-d	It means to ask the DNS setting.
-D	It means to ask the DNS name.
-n	It means to ask NTP.
-i	It means to ask NIS.
-I	It means to ask NIS name.
-p	It means to ask NISP.
-P	It means to ask NISP name.
-b	It means to ask BCMCS.
-B	It means to ask BCMCS name.
-r	It means to ask refresh time.
<i>parameter</i>	1: the parameter related to the request will be displayed. 0: the parameter related to the request will not be displayed.

Example

```

> ip6 dhcp req_opt WAN2 -S 1
> ip6 dhcp req_opt WAN2 -r 1
> ip6 dhcp req_opt WAN2 -a
% Interface WAN2 is set to request following DHCPv6 options:
%   sip name
>

```

Telnet Command: ip6 dhcp client

This command allows you to use DHCPv6 protocol to obtain IPv6 address from server.

Syntax

`ip6 dhcp client <WAN1>.../<WAN10> [-<command> <parameter>] ...]`

Syntax Description

Parameter	Description
<i>client</i>	It means the dhcp client settings.
<i>[<command><parameter>]...</i>	The available commands with parameters are listed below. <i>[...]</i> means that you can type in several commands in one line.
<i>-a</i>	It means to show current DHCPv6 status.
<i>-r</i>	It means to send RELEASE MESSAGE.
<i>-p [IAID]</i>	It means to request identity association ID for Prefix Delegation.
<i>-n [IAID]</i>	It means to request identity association ID for Non-temporary Address.
<i>-t <time></i>	It means to set solicit interval. <time>: 0 ~ 7 seconds (default value is 0).
<i>-c <parameter></i>	It means to send rapid commit to server. 1: Enable 0: Disable
<i>-i <parameter></i>	It means to send information request to server. 1: Enable 0: Disable
<i>-e <parameter></i>	It means to enable or disable the DHCPv6 client. 1: Enable 0: Disable
<i>-m <parameter></i>	It means to enable/disable server DUID set by Link layer and time. 1: Enable 0: Disable
<i>-d</i>	It means to display the client DUID.
<i>-A <parameter></i>	It means to set authentication protocol. 0: Undefine 2: delayed protocol
<i>-R <parameter></i>	It means to set realm value (max: 31 characters) in delayed protocol. <parameter>: Enter a string.
<i>-S <parameter></i>	It means to set shared secret (max: 31 characters) in delayed protocol. <parameter>: Enter a string.
<i>-K <parameter></i>	It means to set key ID (1~65535) in delayed protocol. <parameter>: Enter a number.

Example

```
> ip6 dhcp client WAN2 -p 2008::1
This setting will take effect after rebooting.
Please use "sys reboot" command to reboot the router.
```

```

> ip6 dhcp client WAN2 -a
% Interface WAN2 has following DHCPv6 client settings:
%   DHCPv6 client disabled
%   request IA_PD whose IAID equals to 2008
%   request IA_NA whose IAID equals to 2008
%   Solicit interval: 0
%   Authentication protocol: Undefined
%   Realm:
%   Shared secret key:
%   Key ID: 0

> system reboot

```

Telnet Command: ip6 dhcp server

This command allows you to configure DHCPv6 server.

Syntax

```
ip6 dhcp server [-<command> <parameter>| ... ]
```

Syntax Description

Parameter	Description
<i>server</i>	It means the dhcp server settings.
[<command> <parameter> ...]	The available commands with parameters are listed below. [...] means that you can Enter several commands in one line.
-a	It means to show current DHCPv6 status.
-b	It means to show current DHCPv6 IP assignment table.
-n <name>	It means to set a pool name.
-c <parameter>	It means to send rapid commit to server. 1: Enable 0: Disable
-e <parameter>	It means to enable or disable the DHCPv6 server. 1: Enable 0: Disable
-t <time>	It means to set prefer lifetime.
-y <time>	It means to set valid lifetime.
-u <time>	It means to set T1 time.
-o <time>	It means to set T2 time.
-i <pool_min_addr>	It means to set the start IPv6 address of the address pool.
-x <pool_max_addr>	It means to set the end IPv6 address of the address pool.
-R	It means to send reconfigure packet to the client.
-r <0/1>	It means to disable (0) or enable (1) the auto range.
-N <0/1>	It means to disable (0) or enable (1) the random address allocation.
-d <addr>	It means to set the first DNS IPv6 address. <addr> : Enter an IPv6 address.
-D <addr>	It means to set the second DNS IPv6 address. <addr> : Enter an IPv6 address.

<code>-m <1/0></code>	It means to enable(1) or disable (0) the server DUID set by Link Layer and Time.
<code>-q <name></code>	It means to set DNS domain search list. <name>: Enter a name.
<code>-z <0/1></code>	It means to disable (0) or enable (1) the DHCP PD.
<code>pdadd <suffix> <prefix_len> <client linklocal><client DUID></code>	It means to add PD node.
<code>pddel <PD index></code>	It means to delete PD node. <PD index>: Enter a number.
<code>-A <parameter></code>	It means to set authentication protocol. <parameter>: Enter 0, 2 or 3. 0: Undefine 2: delayed protocol 3: Reconfigure key
<code>- M <parameter></code>	It means to set realm value (max: 31 characters) in delayed protocol. <parameter>: Enter a string.
<code>-S <parameter></code>	It means to set shared secret (max: 31 characters) in delayed protocol. <parameter>: Enter a string.
<code>-K <parameter></code>	It means to set key ID (1~65535) in delayed protocol. <parameter>: Enter a number.

Example

```
> ip6 dhcp server -d FF02::1
> ip6 dhcp server -i ff02::1
> ip6 dhcp server -x ff02::3
> ip6 dhcp server -a
% Interface LAN has following DHCPv6 server settings:
%   DHCPv6 server disabled
%   maximum address of the pool: FF02::3
%   minimum address of the pool: FF02::1
%   1st DNS IPv6 Addr: FF02::1
>
```

Telnet Command: ip6 dhcp option_c

This command allows you to configure settings for DHCPv6 Client for WAN.

Syntax

```
ip6 dhcp option_c -h/l
```

```
ip6 dhcp option_c -d <idx>
```

```
ip6 dhcp option_c -e <1 or 0> -w <wan unumber> -c <option number> -v <option value>
```

```
ip6 dhcp option_c -e <1 or 0> -w <wan unumber> -c <option number> -x <option value>
```

```
ip6 dhcp option_c -e <1 or 0> -w <wan unumber> -c <option number> -a <option value>
```

```
ip6 dhcp option_c -u <idx unumber>
```

Syntax Description

Parameter	Description
-l	It means to list all custom set DHCP6 options.
-d <idx>	It means to delete custom dhcp6 client option. <idx> - The index number of the custom dhcp6 client option. The maximum number is 35.
-e <1 or 0>	Enable/disable option feature. 1:enable, 0:disable
-w <wan unumber>	It means to specify a WAN interface. <wan number> - 1, 2, 3... 10
-c <option number>	It means to set the value of the option number (range: 0~65535). <option number> - 0 -65535.
-v <option>	It means to enter a string. <option number> - A string.
-x <option number>	It means to set the option number by raw byte (hex).
-a <option number>	It means to set the option value by Ipv6 address. <option number> - An Ipv6 address.
-u <idx unumber>	It means to update the option number by index number. -r: remove all custom DHCPv6 Client options
-r	It means to remove all the customized DHCPv6 client options.

Example

```

> ip6 dhcp option_c -e 1 -w 1/2 -c 30 -v domain_name
> ip6 dhcp option_c -l
% state  idx interface      opt   type   data
% enable 1  WAN1|2          30    ASCII  domain_name
>

```

Telnet Command: ip6 dhcp option_s

This command allows you to configure settings for DHCPv6 server for LAN.

Syntax

ip6 dhcp option_s -h/l

ip6 dhcp option_s -d <idx>

ip6 dhcp option_s -e <1 or 0> -i <lan unumber> -c <option number> -v <option value>

ip6 dhcp option_s -e <1 or 0> -i <lan unumber> -c <option number> -x <option value>

ip6 dhcp option_s -e <1 or 0> -i <lan unumber> -c <option number> -a <option value>

ip6 dhcp option_s -u <idx unumber>

Syntax Description

Parameter	Description
-l	It means to list all custom set DHCP6 server options.
-d <idx>	It means to delete custom dhcp6 client option. <idx> - The index number of the custom dhcp6 client option. The maximum number is 40.
-e <1 or 0>	Enable/disable option feature. 1:enable, 0:disable
-i <lan unumber>	It means to specify a LAN interface.

	<lan number> a:all lan, r:routed subnet, -1:lan1, -2:lan2, and etc.
-c <option number>	It means to set the value of the option number (range: 0-65535). <option number> - 0 -65535.
-v <option>	It means to enter a string. <option number> - A string.
-x <option number>	It means to set the option number by raw byte (hex).
-a <option number>	It means to set the option value by Ipv6 address. <option number> - An Ipv6 address.
-u <idx unumber>	It means to update the option number by index number. -r: remove all custom DHCPv6 Client options
-r	It means to remove all the customized DHCPv6 client options.

Example

```

> ip6 dhcp option_s -e 1 -i 1/2 -c 18 -x 2F70617468
> % state  idx interface      opt   type   data
% enable  1   LAN1/2          18    Hex    2f70617468
>

```

Telnet Command: ip6 internet

This command allows you to configure settings for accessing Internet.

Syntax

ip6 internet -W n -M n [-<command> <parameter> | ...]

Syntax Description

Parameter	Description
-W n	W means to set WAN interface and n means different selections. Default is WAN1. n=1: WAN1 n=2: WAN2 n=3: WAN3 . . n=X: WANx
-M n	M means to set Internet Access Mode (Mandatory) and n means different modes (represented by 0 - 7) n= 0: Offline, n=1: PPP, n=2: TSPC, n=3: AICCU, n=4: DHCPv6, n=5: Static n=6:6in4-Static n=7:6rd
[<command> <parameter> ...]	The available commands with parameters are listed below. [...] means that you can type in several commands in one line.
-m n	It means to set IPv6 MTU.

	N = any value (0 means "unspecified").
<i>6rd</i>	It means to set Username. <username>= type a name as the username (maximum 63 characters).
<i>-C <n></i>	It means to set 6rd connection mode. n=0: Auto n=1: Static
<i>-s <server></i>	It means to set 6rd IPv4 Border Relay. <server>: Enter a string.
<i>-m <n></i>	It means to set 6rd IPv4 address mask length. <n>: Enter a number.
<i>-p <prefix></i>	It means to set IPv6 prefix for 6rd connection. <prefix>: Enter a prefix number of IPv6 address.
<i>-l <n></i>	It means to set the prefix length for 6rd connection. <n>: It means to enter a fixed value as the length of the prefix.
<i>6in4</i>	It means to view IPv6 Internet Access Profile.
<i>-s <server></i>	It means to set 6in4 remote endpoint IPv4 address.
<i>-l <IPv6 Addr></i>	It means to set the IPv6 address for 6in4 connection.
<i>-P <n></i>	It means to set IPv6 WAN prefix length for 6in4 connection.
<i>-p <prefix></i>	It means to set 6in4 LAN Routed Prefix.
<i>-l <n></i>	It means to set 6in4 LAN Routed Prefix length.
<i>-T <n></i>	It means to set 6in4 Tunnel TTL.
<i>TSPC/AICCU</i>	
<i>-u <username></i>	It means to set username (max. 63 characters). <username>: Enter a string.
<i>-P <password></i>	It means to set Password (max. 63 characters). <password>: Enter a password.
<i>-s <server></i>	It means to set Tunnel Server IP. <server>: Enter an IPv4 Address or URL (max. 63 characters)
<i>AICCU</i>	
<i>-p <prefix></i>	It means to set Subnet Prefix (AICCU). <prefix>: Enter a prefix number of IPv6 address.
<i>-l <n></i>	It means to set Subnet Prefix length (AICCU). <n>: Enter a number.
<i>-o <1/0></i>	It means to set AICCU always on. 1: on 0: off
<i>-f</i>	It means to set AICCU tunnel ID.
<i>Static</i>	
<i>-w <addr></i>	It means to set Default Gateway. <addr>: Enter an IPv6 address.
<i>Others</i>	
<i>-d <server></i>	It means to set 1st DNS Server IP. <server>: Enter an IPv6 address.
<i>-D <server></i>	It means to set 2nd DNS Server IP. <server>: Enter an IPv6 address.
<i>-t <dhcp/ra/none></i>	It means to set ipv6 PPP WAN test mode for DHCP or RA. <dhcp/ra/none> : Enter dhcp, ra or none.
<i>-V</i>	It means to view IPv6 Internet Access Profile.
<i>-k</i>	It means to dial the Tunnel on the WAN.
<i>-j</i>	It means to drop the Tunnel on the WAN.
<i>-r n</i>	It means to set Prefix State Machine RA timeout.
<i>-c n</i>	It means to set Prefix State Machine DHCPv6 Client timeout.

<code>-q <0/1/2></code>	It means to set WAN detection mode. 0:NS Detect 1:Ping Detect 2:Always On
<code>-z <value></code>	It means to set Ping Detect TTL (0-255). <value>: Enter 0-255.
<code>-x <hostname/ IPv6 addr></code>	It means to set Ping Detect Host (hostname or IPv6 address). <hostname/ipv6 addr> : Enter a hostname or an IPv6 address.
<code>-i <value></code>	It means to set ipv6 connection interval. <value>: Enter a number (1500-60000 (unit:10ms)).
<code>-b <0/1></code>	It means to enable DNSv6 based on DHCPv6. 1 = on 0 = off
<code>-R <0/1></code>	It means to Enable RIPng. 1 = on 0 = off

Example

```
> ip6 internet -W 2 -M 2 -u 88886666 -p draytek123456 -s
amsterdam.freenet6.net
  This setting will take effect after rebooting.
  Please use "sys reboot" command to reboot the router.
> system reboot
```

Telnet Command: ip6 neigh

This command allows you to display IPv6 neighbour table.

Syntax

`ip6 neigh -s <inet6_addr> <eth_addr> <LAN1/..LAN100/WAN1/...WAN10>`

`ip6 neigh -d <inet6_addr> <LAN1/..LAN100/WAN1/...WAN10>`

`ip6 neigh -a <inet6_addr> <LAN1/..LAN100/WAN1/...WAN10>`

Syntax Description

Parameter	Description
<code>-s <inet6_addr> <eth_addr> <LAN1/..LAN100/WAN1/...WAN10 ></code>	It means to add a neighbour. <inet6_addr>: Enter an IPv6 address. <eth_addr>: Enter a submask address. <LAN1/..LAN100/WAN1/...WAN10>: Specify an interface for the neighbor.
<code>-d <inet6_addr> <LAN1/..LAN100/WAN1/...WAN10></code>	It means to delete a neighbour. <inet6_addr>: Enter an IPv6 address. <LAN1/..LAN100/WAN1/...WAN10>: Specify an interface for the neighbor.
<code>-a <inet6_addr> <LAN1/..LAN100/WAN1/...WAN10></code>	It means to show neighbour status. <inet6_addr>: Enter an IPv6 address. <LAN1/..LAN100/WAN1/...WAN10>: Specify an interface for the neighbor.

Example

```
> ip6 neigh -s 2001:2222:3333::1111 00:50:7F:11:ac:22:WAN2
```

```

    Neighbour 2001:2222:3333::1111 successfully added!
> ip6 neigh -a

I/F  ADDR                                MAC                                STATE
-----
LAN1  ::
    LAN1 2001:2222:3333::1111          FAILED
>

```

Telnet Command: ip6 pneigh

This command allows you to add a proxy neighbour.

Syntax

ip6 pneigh -s <inet6_addr> <LAN1|LAN2|...|LAN100|WAN1|...|WAN10>

ip6 pneigh -d <inet6_addr> <LAN1|LAN2|...|LAN100|WAN1|...|WAN10>

ip6 pneigh -a <inet6_addr><-N LAN1|LAN2|...|LAN100|WAN1|...|WAN10>

Syntax Description

Parameter	Description
-s <inet6_addr> <LAN1 LAN2 ... LAN100 WAN1 ... WAN10>	It means to add a proxy neighbour. <inet6_addr>: Enter an IPv6 address. <LAN1 LAN2 ... LAN100 WAN1 ... WAN10>: Specify an interface for the proxy neighbor.
-d <inet6_addr> <LAN1 LAN2 ... LAN100 WAN1 ... WAN10>	It means to delete a proxy neighbour. <inet6_addr>: Enter an IPv6 address. <LAN1 LAN2 ... LAN100 WAN1 ... WAN10>: Specify an interface for the proxy neighbor.
-a <inet6_addr> <LAN1 LAN2 ... LAN100 WAN1 ... WAN10>	It means to show proxy neighbour status. <inet6_addr>: Enter an IPv6 address. <LAN1 LAN2 ... LAN100 WAN1 ... WAN10>: Specify an interface for the proxy neighbor.

Example

```

> ip6 neigh -s FE80::250:7FFF:FE12:300 LAN
%    Neighbour FE80::250:7FFF:FE12:300 successfully added!

```

Telnet Command: ip6 route

This command allows you to set ip6 route.

Syntax

ip6 route -s <prefix> <prefix-length> <gateway> <LAN1|LAN2|...|LAN100|WAN1|...|WAN10|VPN1|...|VPN500> <-D>

ip6 route -d <prefix> <prefix-length>

ip6 route -a <LAN1|LAN2|...|LAN100|WAN1|...|WAN10|VPN1|...|VPN500>

ip6 route -D

ip6 route -I

Syntax Description

Parameter	Description
-s <prefix> <prefix-length> <gateway> <LAN1 ... /LAN100/WAN1/.../WAN10/V PN1/.../VPN500> <-D>	It means to add a route. <prefix>: It means to enter the prefix number of IPv6 address. <prefix length>: It means to enter a fixed value as the length of the prefix. <gateway>: It means to enter the gateway of the router. <LAN1/.../LAN100/WAN1/.../WAN10 /VPN1/.../VPN500>: It means to specify LAN or WAN or VPN interface for such address. <-D>: It means that such route will be treated as the default route.
-d <prefix> <prefix-length>	It means to delete a route. <prefix>: It means to enter the prefix number of IPv6 address. <prefix length>: It means to enter a fixed value as the length of the prefix.
-a < LAN1/LAN2/.../LAN100/WAN1 /.../WAN10/VPN1/.../VPN500 >	It means to show the route status. <LAN1/.../LAN100/WAN1/.../WAN10/ VPN1/.../VPN500>: It means to specify LAN or WAN or VPN interface for such address.
-f	It means to clear the routing table.

Example

```
> ip6 route -s FE80::250:7FFF:FE12:500 16 FE80::250:7FFF:FE12:100 LAN1
%      Route FE80::250:7FFF:FE12:500/16 successfully added!
> ip6 route -a LAN1
```

```
PREFIX/PREFIX-LEN                I/F METRIC FLAG NEXT-HOP
-----
::0.0.0.1/128                    LAN1    0 U  ::
FE80::/128                       LAN1    0 U  ::
FE80::21D:AAFF:FE4B:3E80/128     LAN1    0 U  ::
FE80::/64                        LAN1   256 U  ::
FE80::/16                        LAN1  1024 UGS FE80::250:7FFF:FE12:100
FF00::/8                          LAN1   256 U  ::
```

Telnet Command: ip6 ping

This command allows you to ping an IPv6 address or a host.

Syntax

```
ip6 ping <IPv6 address/Host> <LAN1/LAN2/.../LAN100/WAN1/.../WAN10> <send count> <data_size>
```

Syntax Description

Parameter	Description
<IPv6 address/Host>	It means to specify the IPv6 address or host for ping.
<LAN1/LAN2/.../LAN100/WAN1/.../WAN10 > <send count> <data_size>	It means to specify LAN or WAN interface for such address. <send count>: Set how many packets sent for ping. <data_size>: 1 to 1452. Set the data size for each packet to be pinged.

Example

```
> ip6 ping 2001:4860:4860::8888 WAN2

Pinging 2001:4860:4860::8888 with 64 bytes of Data:

Receive reply from 2001:4860:4860::8888, time=330ms
Receive reply from 2001:4860:4860::8888, time=330ms
Receive reply from 2001:4860:4860::8888, time=330ms
Receive reply from 2001:4860:4860::8888, time=330ms
Receive reply from 2001:4860:4860::8888, time=330ms

Packets: Sent = 5, Received = 5, Lost = 0 <% loss>
>
```

Telnet Command: ip6 tracert

This command allows you to trace the routes from the router to the host.

Syntax

```
ip6 tracert <IPv6 address/Host>
```

```
ip6 tracert <IPv6 address/Host> <LAN1/LAN2/.../LAN100/WAN1/.../WAN10>
```

Syntax Description

Parameter	Description
<IPv6 address/Host>	It means to specify the IPv6 address or host for ping.
<LAN1/.../LAN100/WAN1/.../WAN10 >	It means to specify an interface for such address.

Example

```
> ip6 tracert 2001:4860:4860::8888 LAN1
traceroute to 2001:4860:4860::8888, 30 hops max through protocol ICMP
```



```

1 2001:5C0:1400:B::10B8      340 ms
2 2001:4DE0:1000:A22::1     330 ms
3 2001:4DE0:A::1           330 ms
4 2001:4DE0:1000:34::1     340 ms
5 2001:7F8:1: :A501:5169:1 330 ms
6 2001:4860::1:0:4B3       350 ms
7 2001:4860::8:0:2DAF      330 ms
8 2001:4860::2:0:66E      340 ms
9 Request timed out.        *
10 2001:4860:4860::8888    350 ms
Trace complete.
>

```

Telnet Command: ip6 tspc

This command allows you to display TSPC status.

Syntax

ip6 tspc <ifno>

Syntax Description

Parameter	Description
<i>ifno</i>	It means the connection interface. Ifno=1 (means WAN1) Info=2 (means WAN2)

Example

```

> ip6 tspc 2
Local Endpoint v4 Address : 111.243.177.223
Local Endpoint v6 Address : 2001:05c0:1400:000b:0000:0000:0000:10b9
Router DNS name : 8886666.broker.freenet6.net
Remote Endpoint v4 Address :81.171.72.11
Remote Endpoint v6 Address : 2001:05c0:1400:000b:0000:0000:0000:10b8
Tspc Prefixlen : 56
Tunnel Broker: Amsterdam.freenet.net

Status: Connected

>

```

Telnet Command: ip6 radvd

This command allows you to enable or disable RADVD server.

Syntax

ip6 radvd <LAN1/LAN2/.../LAN100> [-<command> <parameter>| ...]

Syntax Description

Parameter	Description
<<command> <parameter>/...>	The available commands with parameters are listed below. <...> means that you can Enter several commands in one line.

-s <0/1>	It means to enable or disable the default lifetime of the RADVD server. 1: Enable the RADVD server. 0: Disable the RADVD server.
-D <0/1/2>	It means to set RDNSS Disable/Enable/Deploy (0/1/2) when WAN is up.
-d <lifetime>	It means to set RA default lifetime.
-i <lifetime>	It means to set RA min interval time(sec).
-I <lifetime>	It means to set RA MAX interval time(sec).
-h <hoplimit>	It means to set RA hop limit.
-m <mtu/auto>	It means to set RA MTU, 1280-1500. mtu: auto - auto select MTU from WAN,
-e <time>	It means to set reachable time.
-a <time/infinity>	It means to set retransmit timer /infinity.
-p <0/1/2>	It means to set radvd default preference Low/Medium/High. 0-low 1-medium 2-high
-v	It means to view radvd configuration.
-V	It means to view setting in RA.
-L <time/infinity>	It means to set prefix valid lifetime.
-P <time/infinity>	It means to set prefix preferred lifetime.
-r <num>	It means to to set RA test for item. <num>: 0, 121, 124 0: default, 121: logo 121, 124: logo 124..
-R	It means to reload Config and send RA for subnets.
-u	It means to view MTU on all interfaces.

Example

```

> ip6 radvd LAN1 -s 1
% [LAN1] setting !
%   Enable LAN1 radvd OK!
  This setting will take effect after rebooting.
  Please use "sys reboot" command to reboot the router.> ip6 radvd -V
> ip6 radvd LAN1 -d 1800
% [LAN1] setting !
%   Set default lifetime ok: 1800 !
> ip6 radvd LAN1 -V
% [LAN1] setting !
%   Default Lifetime       : 0 seconds
%   min interval time     : 200 seconds
%   MAX interval time     : 600 seconds
%   Hop limit             : 64
%   MTU                   : 0
%   Reachable time        : 0
%   Retransmit time       : 0
%   Preference            : Medium
>

```

Telnet Command: ip6 mngt

This command allows you to manage the settings for access list.

Syntax

`ip6 mngt list`

`ip6 mngt list [add <Index> <IPv6 Object Index> |remove <Index>|flush]`

`ip6 mngt status`

`ip6 mngt <internet/http/telnet/ping/https/ssh/enforce_https> <on/off>`

Syntax Description

Parameter	Description
<i>list</i>	It means to show the setting information of the access list.
<i>add <Index> <IPv6 Object Index> remove <Index> flush</i>	It means to add an IPv6 address which can be used to execute management through Internet. <Index >: 1 to 10. Ten profiles can be set for IPv6 access list. <IPv6 Object Index>: It means the index number of IP object (1 to 64) . remove <Index>: It means to remove (delete) the specified IP object.
<i>flush</i>	It means to clear the IPv6 access table.
<i>status</i>	It means to show the status of IPv6 remote management.
<i>internet/ http/telnet/ping/https/ssh /enforce_https</i>	These protocols are used for accessing Internet.
<i>on/off</i>	It means to enable (on) or disable (off) the Internet accessing through http/telnet/ping.

Example

```
> ip6 mngt list add 1 1
%% Set OK.
% IPv6 Access List :
> ip6 mngt status
% IPv6 Remote Management :
internet access : off, telnet : off, http : off, https : off, ssh :
off, ping : off, enforce_https : off
```

Telnet Command: ip6 online

This command allows you to check the online status of IPv6 LAN /WAN.

Syntax

`ip6 online <WAN1/.../WAN10>`

Syntax Description

Parameter	Description
<i><WAN1/.../WAN10></i>	It means the connection interface.

Example

```
> ip6 online WAN1
% WAN1 online status :
% IPv6 WAN1 Disabled
% Default Gateway : ::
```

```

% Interface : DOWN
% UpTime : 0:00:00
% IPv6 DNS Server: :: Static
% IPv6 DNS Server: :: Static
% IPv6 DNS Server: :: Static
% Tx packets = 0, Tx bytes = 0, Rx packets = 0, Rx bytes = 0
% MTU Onlink: 1280 , Config MTU : 0
>

```

Telnet Command: ip6 aiccu

This command allows you to set IPv6 settings for WAN interface with connection type of AICCU.

Syntax

```
ip6 aiccu -i <ifno> -r
```

```
ip6 aiccu -i <ifno> -s
```

Syntax Description

Parameter	Description
<ifno>	It means the connection interface. 1=WAN1 2=WAN2
-r	It means to remove (delete) the specified index number with IPv6 settings.
-s	It means to display the AICCU status.

Example

```

> ip6 aiccu -i 1 -s
ip6 aiccu -i 1 -s
>

```

Telnet Command: ip6 ntp

This command allows you to set IPv6 settings for NTP (Network Time Protocols) server.

Syntax

```
ip6 ntp -h
```

```
ip6 ntp -v
```

```
ip6 ntp -p <0/1>
```

Syntax Description

Parameter	Description
-h	It is used to display the usage of such command.
-v	It is used to show the NTP state.
-p <0/1>	It is used to specify NTP server for IPv6. 0 - Auto 1 - First Query IPv6 NTP Server.

Example

```
> ip6 ntp -p 1
% Set NTP Priority: IPv6 First
```

Telnet Command: ip6 lan

This command allows you to set IPv6 settings for LAN interface.

Syntax

```
ip6 lan -l n <-<l:w:d:D:m:o:s> <parameter> / ... >
```

Syntax Description

Parameter	Description
-h	It is used to display the usage of such command.
-l <n>	It means to selete LAN interface to be set. n= 1: LAN1 n= 2: LAN2, ... x: LANx. Default is LAN1
-w <n>	It means to selete WAN interface to be primary interface. n= 0: None, n=1: WAN1 , n=2: WAN2, ... x: WANx.
-d <server>	It means to set 1st DNS Server IP. <server>: Enter the IPv6 Address.
-D <server>	It means to set 2nd DNS Server IP. <server>: Enter the IPv6 Address.
-m <n>	It means to set ipv6 LAN management. n=0:OFF n=1:SLAAC. Default is SLAAC n=2:DHCPv6
-o <n>	It means to enable Other option(O-bit) flag. (O-bit is redundant when management is DHCPv6) n=0: Disable n=1: Enable.
-e <n>	It means to add an extension WAN. n: 1: WAN1, 2: WAN2, ... x: WANx.
-E <n>	It means to delete an extension WAN. n: 1: WAN1 ,2: WAN2, ... x: WANx.
-b <map>	It means to set bit map(decimal) for extension WAN. <map>: 0: WAN1; 1: WAN2, ... n: WAN(n+1).
-f <n>	It means to disable IPv6. n=1: Disable IPv6, n=0: Enable IPv6.
-R <n>	It means to enable /disable RIPng. n=1: Enable RIPng, n=0: Disable RIPng.
-s <n>	It means to show IPv6 LAN setting. n=0:show all. Default is show all. n=1 to 8: LAN1 to LAN8. n=17: DMZ.

Example

```
> ip6 lan -l 2 -w 1 -d 2001:4860:4860::8888 -o 1 -f 0 -s 2
% Set LAN2!

% Set primary WAN1!

% Set 1st DNS server 2001:4860:4860::8888
```

```

% Set Other Option Enable!

% [LAN2] support ipv6!

This setting will take effect after rebooting.
Please use "sys reboot" command to reboot the router.

% [LAN2] setting:
% Primary WAN : WAN1
% Management : SLAAC
% Other Option : Enable
% WAN Exten : None
% Subnet ID : 2
% Static IP(0) : ::/0
% [ifno: 0, enable: 0]
% Static IP(1) : ::/0
% [ifno: 0, enable: 0]
% Static IP(2) : ::/0
% [ifno: 0, enable: 0]
% Static IP(3) : ::/0
% [ifno: 0, enable: 0]
% DNS1 : 2001:4860:4860::8888
% DNS2 : 2001:4860:4860::8844
% ULA Type : OFF
% RIPng : Enable

>

```

Telnet Command: ipv6 session

This command allows you to set sessions limit for IPv6 address.

Syntax

ipv6 session on

ipv6 session off

ipv6 session default <num>

ipv6 session status

ipv6 session show

ipv6 session add <IP1-IP2><num>

ipv6 session del <IP1>/<all>

Syntax Description

Parameter	Description
<i>on</i>	It means to turn on session limit for each IP.
<i>off</i>	It means to turn off session limit for each IP.
<i>default <num></i>	It means to set the default number of session num limit. <num>: Enter a number.
<i>status</i>	It means to display the current settings.
<i>show</i>	It means to display all IP range session limit settings.
<i>add</i>	<add/del>: It means to add the session limit for an IPv6 range. <IP1-IP2> : Specify a range for IPv6 addresses. <num>: Enter a number.
<i>del</i>	: It means to delete the session limit for an IPv6 range. <IP1> : Specify the first IPv6 address within the IPv6 range. all: Delete all the session limits.

Example

```
> ip6 session on
> ip6 session add 2100:ABCD::2-2100:ABCD::10 100
> ip6 session status

IPv6 range:
  2100:ABCD::2 - 2100:ABCD::10 : 100

Current ip6 session limit is turn on

Current default session number is 100
>
```

Telnet Command: ip6 bandwidth

This command allows you to set IPv6 settings for bandwidth control.

Syntax

`ip6 bandwidth on`

`ip6 bandwidth off`

`ip6 bandwidth default <tx_rate> <rx_rate>`

`ip6 bandwidth status`

`ip6 bandwidth show`

`ip6 bandwidth add <IP1-IP2> <tx><rx><shared>`

`ip6 bandwidth del <IP1> /all`

Syntax Description

Parameter	Description
<code>on</code>	It means to turn on bandwidth limit for each IP.
<code>off</code>	It means to turn off bandwidth limit for each IP.
<code>default <tx_rate> <rx_rate></code>	It means to set the default transmission (tx), receiving (rx) rate of bandwidth limit (0-30000 Kbps/Mbps). <tx_rate>: Enter a number. <rx_rate>: Enter a number.
<code>status</code>	It means to display the current settings.
<code>show</code>	It means to display all IP range bandwidth limit settings.
<code>add <IP1-IP2> <tx><rx><shared></code>	<add>: It means to add the bandwidth limit for an IPv6 range. : It means to delete the bandwidth limit for an IPv6 range by first IP (IP1) or 'del all'. <IP1-IP2> - Specify a range for IPv6 addresses. <tx><rx>: It means the bandwidth limit for transmission and receive rate. <shared>: It means the bandwidth will be shared for the IPv6 range.
<code>del <IP1> /all</code>	It means to delete the bandwidth limit for an IPv6 range by first IP (IP1) or del all. <IP1> : Specify the first IPv6 address within the IPv6 range. all: Delete all the session limits.

Example

```
> ip6 bandwidth on
> ip6 bandwidth add 2001:ABCD::2-2001:ABCD::10 512 5M shared
```

```

> ip6 bandwidth status

IPv6 range:
  2001:ABCD::2 - 2001:ABCD::10 : Tx:512K Rx:5M shared

Current ip6 Bandwidth limit is turn on

Current default ip6 Bandwidth rate is Tx:2000K Rx:8000K bps
>

```

Telnet Command: ipf view

IPF users to view the version of the IP filter, to view/set the log flag, to view the running IP filter rules.

Syntax

```
ipf view [-VcdhrtzZ]
```

Syntax Description

Parameter	Description
-V	It means to show the version of this IP filter.
-d	It means to show the running data filter rules.
-h	It means to show the hit-number of the filter rules.
-r	It means to show the running call and data filter rules.
-t	It means to display all the information at one time.
-z	It means to clear a filter rule's statistics.
-Z	It means to clear IP filter's gross statistics.

Example

```

> ipf view -V -d
ipf: IP Filter: v3.3.1 (14800)
Kernel: IP Filter: v3.3.1
Running: yes
Log Flags: 0x0 = none set
Default: pass all, Logging: available
>

```

Telnet Command: ipf set

This command is used to set general rule, filter set and filter rule for firewall.

Syntax

```
ipf set <Options>
```

```
ipf set <SET_NO><Options>
```

```
ipf set <SET_NO> rule <RULE_NO><Options>
```

Syntax Description

Parameter	Description
<Options>	It means to set the firewall general setup and default rule.
<SET_NO><Options>	It means to set the firewall filter set including comments and next filter set.
<SET_NO> rule <RULE_NO><Options>	It means to set the firewall rule in filter set. For detailed information, refer to Telnet Command: ipf rule.
<i>About ipf set <options></i>	
-v	It means to view the configuration of general set.
-c <p1>	It means to setup Call Filter. <p1>: Specify the index number (1 to 12) of the set profile. To disable the setting, enter "0".
-d <p1>	It means to setup Data Filter. <p1>: Specify the index number (1 to 12) of the set profile. To disable the setting, enter "0".
-p <p1><p2>	It means to setup actions for packet not matching any rule and whether record syslog. <p1>: Type "0" to let packets not matching any rule pass; Type "1" to block the packets not matching any rule. <p2>: "0" means the log related to rule matching will not be recorded on Syslog; "1" means the log related to rule matching will be recorded on Syslog. For example, to set pass for packet not matching any rule and enable syslog, -p 0 1 .
-R <v4/v6> <Enable/Disable>	It means to accept routing packet from WAN. <v4/v6>: IPv4 or IPv6. <Enable/Disable>: Enter 0 (enable) or 1 (disable). Set Accept routing packet from WAN by IPv4, please enter -R v4 0 .
-L <p1>	It means to enable or disable the Strict Security Firewall function. <p1>: Enter 1(enable) or 0 (disable).
-C <p1>	It means to setup Code Page. <p1>: Enter a code page number (0 to 20). For example, ipf set -C 20. 0. None 1. ANSI(1250)-Central Europe 2. ANSI(1251)-Cyrillic 3. ANSI(1252)-Latin I 4. ANSI(1253)-Greek 5. ANSI(1254)-Turkish 6. ANSI(1255)-Hebrew 7. ANSI(1256)-Arabic 8. ANSI(1257)-Baltic 9. ANSI(1258)-Viet Nam 10. OEM(437)-United States 11. OEM(850)-Multilingual Latin I 12. OEM(860)-Portuguese

	<p>13. OEM(861)-Icelandic</p> <p>14. OEM(863)-Canadian French</p> <p>15. OEM(865)-Nordic</p> <p>16. ANSI/OEM(874)-Thai</p> <p>17. ANSI/OEM(932)-Japanese Shift-JIS</p> <p>18. ANSI/OEM(936)-Simplified Chinese GBK</p> <p>19. ANSI/OEM(949)-Korean</p> <p>20. ANSI/OEM(950)-Traditional Chinese Big5</p>
<i>-M <p1><p2></i>	<p>It means to setup APP Enforcement and Syslog.</p> <p><p1>: Enter a number (0 to 32). In which, 0 means none; 1 to 32 mens the index number of the profile.</p> <p><p2>: "0" means the log related to APP Enforcement will not be recorded on Syslog; "1" means the log related to APP Enforcement will be recorded on Syslog.</p>
<i>-U <p1><p2></i>	<p>It means to setup URL Content Filter for packets not matching any rule.</p> <p><p1>: Enter a number (0 to 8). In which, 0 means none; 1 to 8 mens the index number of the profile.</p> <p><p2>: "0" means the log related to URL Content Filter will not be recorded on Syslog; "1" means the log related to URL Content Filter will be recorded on Syslog.</p>
<i>-W <p1><p2></i>	<p>It means to setup Web Content Filter for packets not matching any rule.</p> <p><p1>: Enter a number (0 to 8). In which, 0 means none; 1 to 8 mens the index number of the profile.</p> <p><p2>: "0" means the log related to Web Content Filter will not be recorded on Syslog; "1" means the log related to Web Content Filter will be recorded on Syslog.</p>
<i>-D <p1><p2></i>	<p>It means to setup DNS Filter for packets not matching any rule.</p> <p><p1>: Enter a number (0 to 8). In which, 0 means none; 1 to 8 mens the index number of the profile.</p> <p><p2>: "0" means the log related to DNS Filter will not be recorded on Syslog; "1" means the log related to DNS Filter will be recorded on Syslog.</p>
<i>-a <p1></i>	<p>It means to configure the advanced settings.</p>
<i>-f <p1></i>	<p>It means to accept large incoming fragmented UDP or ICMP packets.</p> <p><p1>: Enter 1(enable) or 0 (disable).</p>
<i>-t <p1></i>	<p>It means to enable or disable the Transparent Mode.</p> <p><p1>: Enter 1(enable) or 0 (disable).</p>
<i>-E <p1><p2></i>	<p>It means to set the maximum count for session limitation.</p> <p><p1>: Enter a number (0 to 50000)</p> <p><p2>: "0" means the log related to session control will not be recorded on Syslog; "1" means the log related to session control will be recorded on Syslog.</p>
<i>-Q <p1><p2></i>	<p>It means to set the QoS Class.</p> <p><p1>: Enter a number (0 to 4).</p> <p>0: None</p> <p>1: Class 1</p>

	<p>2: Class 2 3: Class 3 4: Default Class</p> <p><p2>: "0" means the log related to QoS Class will not be recorded on Syslog; "1" means the log related to QoS Class will be recorded on Syslog.</p>
<i>-Y <p1><p2></i>	<p>It means to set the User Management.</p> <p><p1>: Enter a number (-1 to 2).</p> <p>-1: None 0: All 1: user object 2: user group</p> <p><p2>: 1 to 200(if p1 is set with 1, user object) or 1 to 32(if p1 is set with 2, user group)</p>
<i>-y <p1></i>	<p>It means the log related to User Management will be or be not recorded on Syslog.</p> <p><p1>: Enter 1(enable) or 0 (disable).</p>
<i>-w <p1></i>	<p>It means to set the window size of TCP protocol.</p> <p><p1>: Enter a value (0 to 65535).</p>
<i>-A <p1></i>	<p>It means to enable or disable the function of packet capture.</p> <p><p1>: Enter 1(enable) or 0 (disable).</p>
<i>About ipf set <SET_NO><Options></i>	
<i>-m <Comments></i>	<p>It means to set comment for a filter set.</p> <p><Comments>: Enter a description for the filter set.</p>
<i>-v</i>	<p>It means to view the comment and the next filter set.</p>
<i>-n <NEXT_SET_NO></i>	<p>It means to specify the next filter set of current filter set.</p> <p><NEXT_SET_NO>: Enter a number (1 to 12).</p> <p>For example, ipf set 1 -n 2.</p>
<i>About ipf set <SET_NO> rule <RULE_NO><Options></i>	
<i><SET_NO></i>	<p>Range from 1 to 50.</p>
<i><RULE_NO></i>	<p>Range from 1 to 30.</p>
<i>-e <1/0></i>	<p>Enable the filter set.</p> <p><1/0>: Enter 1(enable) or 0 (disable).</p>
<i>-v</i>	<p>It means to view the configuration of the rule set.</p>
<i>-D <value></i>	<p>It means to set the direction of the rule.</p> <p><value>: 0, 1, 2 0 - LAN/RT/VPN -> WAN 1 - WAN -> LAN/RT/VPN 2 - LAN/RT/VPN -> LAN/RT/VPN 3 - WAN -> Localhost</p>
<i>-l e/d <para1,para2,...></i>	<p>It means to set incoming interface.</p> <p>e: enable; d:disable</p> <p><para1,para2,...>: Specify interfaces including all, LAN1 to LAN100, DMZ, RT, VPN, WAN1 to WAN52.</p> <p>RT means IP Routed Subnet.</p>

<p><code>-O e/d <para1,para2,...></code></p>	<p>It means to set outgoing interface. e: enable; d:disable <para1,para2,...>: Specify interfaces including all, LAN1 to LAN100, DMZ, RT, VPN, WAN1 to WAN52. RT means IP Routed Subnet.</p>
<p><code>-s "o/o6/g/g6/c <field> <obj>"</code></p>	<p>It means to specify source IP object, IP group or country object. o: IP object. Ranges from 0 to 192. 0 means none. o6: IPv6 object. Ranges from 0 to 64. 0 means none. g: IP group. Ranges from 0 to 32. 0 means none. g6: IPv6 group. Ranges from 0 to 32. 0 means none. c: country object. Ranges from 1 to 32. <field> Indicates the quantity of objects/groups can be set for this rule at one time. -2 object profiles are allowed for IPv4 -2 group profiles are allowed for IPv4 group -3 object profiles are allowed for IPv6 -1 group profiles is allowed for IPv6 group <obj>: indicates index number of object or index number of group. -Range for IPv4, from 1 to 192, 0 means none. -Range for IPv4 group, from 1 to 32, 0 means none. -Range for IPv6, from 1 to 64, 0 means none. -Range for IPv6 group, from 1 to 32, 0 means none. -Ranges for country object, from 1 to 32. For example, -s "o 1 2" means IPv4 object profile 1 and 2 are set as source IP. Example: > ipf rule 3 1 -e 1 -s "o 1 2"</p>
<p><code>-d "o/o6/g/g6/c <field> <obj>"</code></p>	<p>It means to set the destination object, group or country. o: IP object. Ranges from 0 to 192. 0 means none. o6: IPv6 object. Ranges from 0 to 64. 0 means none. g: IP group. Ranges from 0 to 32. 0 means none. g6: IPv6 group. Ranges from 0 to 32. 0 means none. c: country object. Ranges from 1 to 32. <field> Indicates the quantity of objects/groups can be set for this rule at one time. -2 object profiles are allowed for IPv4 -2 group profiles are allowed for IPv4 group -3 object profiles are allowed for IPv6 -1 group profiles is allowed for IPv6 group <obj>: indicates index number of object or index number of group. -Range for IPv4, from 1 to 192, 0 means none. -Range for IPv4 group, from 1 to 32, 0 means none. -Range for IPv6, from 1 to 64, 0 means none. -Range for IPv6 group, from 1 to 32, 0 means none. -Ranges for country object, from 1 to 32. For example, -d "o 1 2" means IPv4 object profile 1 and 2 are set as destination IP.</p>

	Example: > ipf rule 3 1 -e 1 -d "o 2 2"
-d "u <Address Type> <Start IP Address> <End IP Address> / <Address Mask>"	<p>It means to configure destination IP address including address type, start IP address, end IP address and address mask.</p> <p>u : It means "user defined".</p> <p><i>Address Type</i> : Type the number (representing different address type).</p> <p>0 : Subnet Address 1 : Single Address 2 : Any Address 3 : Range Address</p> <p>Example: Set Subnet Address => -d "u 0 192.168.1.10 255.255.255.0" Set Single Address => -d "u 1 192.168.1.10 " Set Any Address => -d "u 2" Set Range Address => -d "u 3 192.168.1.10 192.168.1.15 "</p>
-S o/g <obj>	<p>It means to set service type object.</p> <p>o : indicates "object" profile. g: indicates "group" profile.</p> <p><obj>: indicates index number of object or index number of group. Available settings range from 1-96. For example, -S "o 1" means the first service type object profile.</p>
-S u <protocol> <source_port_value> <destination_port_value>	<p>It means to set advanced setting of the protocol and the port range for the service type.</p> <p><protocol>: Protocol. Ranges from 0 to 255. In which, TCP(6), UDP(17), TCP/UDP(255), Any(0), ICMP(1), ICMPv6(58), Other(other)</p> <p><source_port_value>: Set port number, port range for the service type. i.e: 1,3,5 1: Port OP, range is 0-3, 0:==, 1:!=, 2:>, 3:< 3: Port range of the Start Port Number, range is 1-65535. 5: Port range of the End Port Number, range is 1-65535.</p> <p><destination_port_vale>: i.e: 2,4,6 2: Port OP, range is 0-3, 0:==, 1:!=, 2:>, 3:< 4: Port range of the Start Port Number, range is 1-65535. 6: Port range of the End Port Number, range is 1-65535.</p>
-f <value>	<p>Set the fragment type.</p> <p><value>: 0 to 3. In which, 0: Dont care 1: ungragmented 2: Fragmented 3: Too short.</p>
-F "<Param 0> <Param 1>"	<p>It means the Filter action you can specify.</p> <p><Param 0>: Enter the number to set the filter action. 0 : Pass Immediately. 1 : Block Immediately. 2 : Pass if no further match.</p>

	<p>3 : Block if no further match.</p> <p><Param 1>: Let the log be recorded on Syslog.</p> <p>0 : Disable Log.</p> <p>1 : Enable Log.</p>
<i>-m</i> " <i><Param 0> <Param 1></i> "	<p>It means to set MAC Bind IP type and the Syslog.</p> <p><Param 0>: Enter the number to choose the type.</p> <p>0 : Non-Strict.</p> <p>1 : Strict.</p> <p><Param 1>: Let the log be recorded on Syslog.</p> <p>0 : Disable Log.</p> <p>1 : Enable Log.</p>
<i>-Y</i> <i><Param 0> <Param 1></i>	<p>It means to set the User Management.</p> <p><Param 0>: Enter the number to choose the type.</p> <p>-1 : None.</p> <p>0 : All.</p> <p>1 : User Object</p> <p>2 : User group</p> <p><Param 1>: Let the log be recorded on Syslog if <Param 0> is set with None/ALL.</p> <p>0 : Disable.</p> <p>1 : Enable.</p> <p>Enter the user object number (1 to 200) / group number (1 to 32) if <param 0> is set with User Object.</p>
<i>-y</i> <i><value></i>	<p>It means the log related to User Management will be or be not recorded on Syslog.</p> <p><value>: Enter 1(enable) or 0 (disable).</p>
<i>-L</i> <i><Param 0> <Param 1></i>	<p>It means to set the maximum count for the session limitation.</p> <p><Param 0>: Enter the number (0 to 150000) to choose the type.</p> <p><Param 1>: Let the log be recorded on Syslog.</p> <p>0 : Disable.</p> <p>1 : Enable.</p>
<i>-q</i> <i><Param 0> <Param 1></i>	<p>It means to set the classification for QoS.</p> <p><Param 0>:</p> <p>1- Class 1,</p> <p>2 - Class 2,</p> <p>3 - Class 3,</p> <p>4 - Other</p> <p><Param 1>: Let the log be recorded on Syslog.</p> <p>0 : Disable.</p> <p>1 : Enable.</p>
<i>-A</i> " <i><Param 0></i> "	<p>It means to enable or disable the packet capture function.</p> <p><Param 0>: Enter 0 or 1.</p> <p>0 : Disable.</p> <p>1 : Enable.</p>
<i>-I</i> <i><Param 0> <Param 1></i>	<p>It means load balance policy.</p> <p>Such function is used for "debug" only.</p>

	<p><Param 0>: Enter 0, 1, 2, or 3.</p> <p>0: Auto-Select, 1: WAN 1. 2: WAN 2. 3: WAN 3.</p> <p><Param 1>: Enter 0 or 1.</p> <p>0: Disable Log. 1: Enable Log.</p>
-a "<Param 0> <Param 1>"	<p>It means to specify which APP Enforcement profile will be applied.</p> <p><Param 0> : Available settings range from 0 ~ 32. "0" means no profile will be applied.</p> <p><Param 1> : Let the log be recorded on Syslog.</p> <p>0 : Disable. 1 : Enable.</p>
-u <Param 0> <Param 1>	<p>It means to specify which URL Content Filter profile will be applied.</p> <p><Param 0> : Available settings range from 0 ~ 8. "0" means no profile will be applied.</p> <p><Param 1> : Let the log be recorded on Syslog.</p> <p>0 : Disable. 1 : Enable.</p>
-w "<Param 0> <Param 1>"	<p>It means to specify which Web Content Filter profile will be applied.</p> <p><Param 0> : Available settings range from 0 ~ 8. "0" means no profile will be applied.</p> <p><Param 1> : Let the log be recorded on Syslog.</p> <p>0 : Disable. 1 : Enable.</p>
-n "<Param 0> <Param 1>"	<p>It means to specify which DNS Filter profile will be applied.</p> <p><Param 0> : Available settings range from 0 ~ 8. "0" means no profile will be applied.</p> <p><Param 1> : Let the log be recorded on Syslog.</p> <p>0 : Disable. 1 : Enable.</p>
-N <value>	<p>It means to set the Next Filter Set.</p> <p><value> : Available settings range from 0 ~ 50. "0" means no profile will be applied.</p> <p>0 : None 1 : Set#1; 2: Set#2, and so on.</p>
-c <0~20>	<p>It means to set code page. Different number represents different code page.</p> <p>0. None 1. ANSI(1250)-Central Europe 2. ANSI(1251)-Cyrillic 3. ANSI(1252)-Latin I 4. ANSI(1253)-Greek 5. ANSI(1254)-Turkish 6. ANSI(1255)-Hebrew</p>

	<p>7. ANSI(1256)-Arabic 8. ANSI(1257)-Baltic 9. ANSI(1258)-Viet Nam 10. OEM(437)-United States 11. OEM(850)-Multilingual Latin I 12. OEM(860)-Portuguese 13. OEM(861)-Icelandic 14. OEM(863)-Canadian French 15. OEM(865)-Nordic 16. ANSI/OEM(874)-Thai 17. ANSI/OEM(932)-Japanese Shift-JIS 18. ANSI/OEM(936)-Simplified Chinese GBK 19. ANSI/OEM(949)-Korean 20. ANSI/OEM(950)-Traditional Chinese Big5</p>
<i>-C "<Windows Size> <Session_Timeout>"</i>	<p>It means to set Window size and Session timeout (Minute). <Windows Size> - Available settings range from 1 ~ 65535. <Session_Timeout> - Make the best utilization of network resources. e.g.: ipf set 1 rule 1 -C "600 30"</p>
<i>-b <value></i>	<p>It means to enable or disable the DrayTek Banner. <value>: 0 : Disable; 1 : Enable.</p>
<i>-t "i <Param 0> <Param 1>"</i>	<p>It means to set schedule profile. Totally, there are four sets of schedule profiles can be specified. <Param 0>: Enter the index number (1 to 4) for each set. <Param 1>: Enter the index number (0 to 15) of the schedule profile for each set. 0 means none. For example, -t "i 1 3" means schedule profile #3 is configured for set #1. Example: > ipf rule 3 1 -e 1 -t "i 1 3"</p>
<i>-t "c <value>"</i>	<p>It means to enable or disable the function of clearing sessions when the schedule is ON. <value>: 0 : Disable; 1 : Enable. i.e: -t "c 1"</p>
<i>-M <Your Comments></i>	<p>It means to set comments for the filter rule. <Your Comments>: Enter a brief description.</p>
<i>-U "<Up or Down>"</i>	<p>It means to move up or move down the order of a filter rule in the filter set. up: It indicates move the filter rule up. down: It indicates move the filter rule down.</p>

Example

```

> ipf set 1 -m sansansan
> ipf set -c 3 -p 0 1
Setting saved.
> ipf set -R "v4 1"
Setting saved.
> ipf set -R "v6 1"
Setting saved.

```



```

> ipf set -v

Call Filter: Enable (Start Filter Set = 3)
Data Filter: Enable (Start Filter Set = 2)
Log Flag   : Disable

Actions for packet not matching any rule:
  Pass or Block      : Pass
  CodePage           : ANSI(1252)-Latin I
  Max Sessions Limit: 150000
  Current Sessions  : 7
  Mac Bind IP        : Non-Strict
  QOS Class          : None
  Packet Capture     : Disable
  APP Enforcement    : None
  URL Content Filter: None
  WEB Content Filter: None
  DNS Filter         : None
  Load-Balance policy : Auto-select

-----

CodePage           : ANSI(1252)-Latin I
Window size        : 65535
Session timeout    : 60
DrayTek Banner     : Enable

-----

Accept large incoming fragmented UDP or ICMP packets: Enable
Transparent Mode   : Disable

-----

Block routing packet from WAN:
  [v] IPv4
  [v] IPv6

-----

[v] Enable Strict Security Firewall
>

```

Telnet Command: ipf rule

This command is used to set filter rule for firewall.

Syntax

`ipf rule s r [-<command> <parameter> | ...`

`ipf rule s r -v`

Syntax Description

Parameter	Description
s	It means the Filter Set. s: Enter a value (1 to 50).

<i>r</i>	It means Filter Rule r: Enter a value (1~30).
[<command> <parameter>[...]]	The available commands with parameters are listed below. [...] means that you can type in several commands in one line.
-e <0/1>	It means to enable or disable the rule setting. 0: disable 1:enable
-v	It is used to show current filter rule settings.
-D <value>	It means to set the direction of packet flow. It is for Data Filter only. 0: LAN/ RT/VPN -> WAN 1: WAN -> LAN/RT/VPN 2: LAN/RT/VPN -> LAN/ RT/VPN 3: WAN ->Localhost PS: RT means IP Routed Subnet
-I "<e/d><para1, para2,...>"	It means to set incoming interface. e: Enable the function. d: Disable the function. Para1, para2,...: Available values include all, LAN1, LAN2, ..., LAN100, DMZ, RT, VPN, WAN1, ..., WAN52. Example: > ipf rule 3 1 -e 1 -I "e LAN1"
-O "<e/d><para1, para2,...>"	It means to set outgoing interface. e: Enable the function. d: Disable the function. Para1, para2,...: Available values include all, LAN1, LAN2, ..., LAN100, DMZ, RT, VPN, WAN1, ..., WAN52. Exampe: > ipf rule 3 1 -e 1 -O "e LAN2"
-s "o/o6/g/g6/c <field> <obj>"	It means to specify source IP object, IP group. o: Indicates "IPv4 object". o6: Indicates "IPv6 object". g: Indicates "IPv4 group". g6: Indicates "IPv6 group". c: Indicates "country object". field: Indicates the quantity of objects/groups that can be set for this rule at one time. -2 object profiles are allowed for IPv4 -2 group profiles are allowed for IPv4 group -3 object profiles are allowed for IPv6 -1 group profiles is allowed for IPv6 group obj : indicates index number of object or index number of group. -Range for IPv4, from 1 to 192, 0 means none. -Range for IPv4 group, from 1 to 32, 0 means none. -Range for IPv6, from 1 to 64, 0 means none. -Range for IPv6 group, from 1 to 32, 0 means none. -Ranges for country object, from 1 to 32. For example, -s "o 1 2" means IPv4 object profile 1 and 2 are set as souce IP. Exampe: > ipf rule 3 1 -e 1 -s "o 1 2"
-s "u <Address Type> <Start IP Address> <End IP Address> / <Address Mask>"	It means to configure source IP address including address type, start IP address, end IP address and address mask. u : It means "user defined". <i>Address Type</i> : Type the number (representing different address

	<p>type).</p> <p>0 : Subnet Address</p> <p>1 : Single Address</p> <p>2 : Any Address</p> <p>3 : Range Address</p> <p>Example:</p> <p>Set Subnet Address => -s "u 0 192.168.1.10 255.255.255.0"</p> <p>Set Single Address => -s "u 1 192.168.1.10 "</p> <p>Set Any Address => -s "u 2 "</p> <p>Set Range Address => -s "u 3 192.168.1.10 192.168.1.15"</p>
-d "o/o6/g/g6/c <field> <obj>"	<p>It means to specify destination IP object, IP group.</p> <p>o: Indicates "IPv4 object".</p> <p>o6: Indicates "IPv6 object".</p> <p>g: Indicates "IPv4 group".</p> <p>g6: Indicates "IPv6 group".</p> <p>c: Indicates "country object".</p> <p>field: Indicates the quantity of objects/groups can be set for this rule at one time.</p> <ul style="list-style-type: none"> -2 object profiles are allowed for IPv4 -2 group profiles are allowed for IPv4 group -3 object profiles are allowed for IPv6 -1 group profiles is allowed for IPv6 group <p>obj : indicates index number of object or index number of group.</p> <ul style="list-style-type: none"> -Range for IPv4, from 1 to 192, 0 means none. -Range for IPv4 group, from 1 to 32, 0 means none. -Range for IPv6, from 1 to 64, 0 means none. -Range for IPv6 group, from 1 to 32, 0 means none. -Ranges for country object, from 1 to 32. <p>For example, -s "o 1 2" means IPv4 object profile 1 and 2 are set as destination IP.</p> <p>Exampe: > ipf rule 3 1 -e 1 -d "o 2 2"</p>
-d "u <Address Type> <Start IP Address> <End IP Address> /<Address Mask>"	<p>It means to configure destination IP address including address type, start IP address, end IP address and address mask.</p> <p>u : It means "user defined".</p> <p><i>Address Type</i> : Type the number (representing different address type).</p> <p>0 : Subnet Address</p> <p>1 : Single Address</p> <p>2 : Any Address</p> <p>3 : Range Address</p> <p>Example:</p> <p>Set Subnet Address => -d "u 0 192.168.1.10 255.255.255.0"</p> <p>Set Single Address => -d "u 1 192.168.1.10 "</p> <p>Set Any Address => -d "u 2 "</p> <p>Set Range Address => -d "u 3 192.168.1.10 192.168.1.15"</p>
-S o/g <obj>	<p>It means to specify Service Type object.</p> <p>o : indicates "object" profile.</p> <p>g: indicates "group" profile.</p> <p><obj> : indicates index number of object or index number of group. Available settings range from 1-96. For example, -S "o 1" means the first service type object profile.</p>
-S "u <protocol> <source_port_value>	<p>It means to configure advanced settings for Service Type, such as protocol and port range.</p>

<i><destination_port_value></i>	<p>u : it means "user defined".</p> <p><protocol> : It means TCP(6),UDP(17), TCP/UDP(255), Any(0), ICMP(1), ICMPv6(58), Other(other)</p> <p><source_port_value> :</p> <p>1 : Port OP, range is 0-3. 0:=, 1:!=, 2:>, 3:<</p> <p>3 : Port range of the Start Port Number, range is 1-65535.</p> <p>5 : Port range of the End Port Number, range is 1-65535.</p> <p><destination_port_value>:</p> <p>2 : Port OP, range is 0-3, 0:==, 1:!=, 2:>, 3:<</p> <p>4 : Port range of the Start Port Number, range is 1-65535.</p> <p>6 : Port range of the End Port Number, range is 1-65535.</p>
<i>-f <value></i>	<p>It means to set fragment type.</p> <p>0 : Don't care.</p> <p>1 : Unfragmented.</p> <p>2 : Fragmented.</p> <p>3 : Too Short</p>
<i>-F "<Param 0> <Param 1>"</i>	<p>It means the Filter action you can specify.</p> <p><param 0>: Enter the number to set the filter action.</p> <p>0 : Pass Immediately.</p> <p>1 : Block Immediately.</p> <p>2 : Pass if no further match.</p> <p>3 : Block if no further match.</p> <p><Param 1>: Let the log be recorded on Syslog.</p> <p>0 : Disable Log.</p> <p>1 : Enable Log.</p>
<i>-m "<Param 0> <Param 1>"</i>	<p>It means to set MAC Bind IP type and the Syslog.</p> <p><param 0>: Enter the number to choose the type.</p> <p>0 : Non-Strict.</p> <p>1 : Strict.</p> <p><Param 1>: Let the log be recorded on Syslog.</p> <p>0 : Disable Log.</p> <p>1 : Enable Log.</p>
<i>-Y <Param 0> <Param 1></i>	<p>It means to set the User Management.</p> <p><param 0>: Enter the number to choose the type.</p> <p>-1 : None.</p> <p>0 : All.</p> <p>1 : User Object</p> <p>2 : User group</p> <p><Param 1>: Let the log be recorded on Syslog if <param 0> is set with None/ALL.</p> <p>0 : Disable.</p> <p>1 : Enable.</p> <p>Enter the the user object number (1 to 200) / group number (1 to 32) if <param 0> is set with User Object.</p>
<i>-y <value></i>	<p>It means the log related to User Management will be or be not recorded on Syslog.</p> <p><value>: Enter 1(enable) or 0 (disable).</p>
<i>-L <Param 1> <Param 2></i>	<p>It means to set the maximum count for the session limitation.</p> <p><Param 1>: Enter the number (0 to 300000) to choose the type.</p> <p><Param 2>: Let the log be recorded on Syslog.</p>

	<p>0 : Disable. 1 : Enable.</p>
<i>-q <Param 0> <Param 1></i>	<p>It means to set the classification for QoS. <Param 0>: 1- Class 1, 2 - Class 2, 3 - Class 3, 4 - Other <Param 1>: Let the log be recorded on Syslog. 0 : Disable. 1 : Enable.</p>
<i>-A "<Param 0>"</i>	<p>It means to enable or disable the packet capture function. <Param 0>: Enter 0 or 1. 0 : Disable. 1 : Enable.</p>
<i>-l <Param 0> <Param 1></i>	<p>It means load balance policy. Such function is used for "debug" only. <Param 0>: Enter 0, 1, 2, or 3. 0:Auto-Select, 1:WAN 1. 2:WAN 2. 3:WAN 3. <Param 1>: Enter 0 or 1. 0:Disable Log. 1:Enable Log.</p>
<i>-a "<Param 0> <Param 1>"</i>	<p>It means to specify which APP Enforcement profile will be applied. <Param 0> : Available settings range from 0 ~ 32. "0" means no profile will be applied. <Param 1> : Let the log be recorded on Syslog. 0 : Disable. 1 : Enable.</p>
<i>-u <Param 0> <Param 1></i>	<p>It means to specify which URL Content Filter profile will be applied. <Param 0> : Available settings range from 0 ~ 8. "0" means no profile will be applied. <Param 1> : Let the log be recorded on Syslog. 0 : Disable. 1 : Enable.</p>
<i>-w "<Param 0> <Param 1>"</i>	<p>It means to specify which Web Content Filter profile will be applied. <Param 0> : Available settings range from 0 ~ 8. "0" means no profile will be applied. <Param 1> : Let the log be recorded on Syslog. 0 : Disable. 1 : Enable.</p>
<i>-n "<Param 0> <Param 1>"</i>	<p>It means to specify which DNS Filter profile will be applied. <Param 0> : Available settings range from 0 ~ 8. "0" means no profile will be applied. <Param 1> : Let the log be recorded on Syslog. 0 : Disable. 1 : Enable.</p>
<i>-N <value></i>	<p>It means to set the Next Filter Set. <value> : Available settings range from 0 ~ 50. "0" means no profile</p>

	<p>will be applied.</p> <p>0 : None</p> <p>1 : Set#1; 2: Set#2, and so on.</p>
<i>-c <0-20></i>	<p>It means to set code page. Different number represents different code page.</p> <p>0. None</p> <p>1. ANSI(1250)-Central Europe</p> <p>2. ANSI(1251)-Cyrillic</p> <p>3. ANSI(1252)-Latin I</p> <p>4. ANSI(1253)-Greek</p> <p>5. ANSI(1254)-Turkish</p> <p>6. ANSI(1255)-Hebrew</p> <p>7. ANSI(1256)-Arabic</p> <p>8. ANSI(1257)-Baltic</p> <p>9. ANSI(1258)-Viet Nam</p> <p>10. OEM(437)-United States</p> <p>11. OEM(850)-Multilingual Latin I</p> <p>12. OEM(860)-Portuguese</p> <p>13. OEM(861)-Icelandic</p> <p>14. OEM(863)-Canadian French</p> <p>15. OEM(865)-Nordic</p> <p>16. ANSI/OEM(874)-Thai</p> <p>17. ANSI/OEM(932)-Japanese Shift-JIS</p> <p>18. ANSI/OEM(936)-Simplified Chinese GBK</p> <p>19. ANSI/OEM(949)-Korean</p> <p>20. ANSI/OEM(950)-Traditional Chinese Big5</p>
<i>-C "<Windows Size> <Session_Timeout>"</i>	<p>It means to set Window size and Session timeout (Minute).</p> <p><Windows Size> - Available settings range from 1 ~ 65535.</p> <p><Session_Timeout> - Make the best utilization of network resources.</p>
<i>-b <value></i>	<p>It means to enable or disable the DrayTek Banner.</p> <p><value>: 0 : Disable; 1 : Enable.</p>
<i>-t "i <Param 0> <Param 1>"</i>	<p>It means to set schedule profile. Totally, there are four sets of schedule profiles can be specified.</p> <p><param 0>: Enter the index number (1 to 4) for each set.</p> <p><param 1>: Enter the index number (0 to 15) of the schedule profile for each set. 0 means none.</p> <p>For example, -t "i 1 3" means schedule profile #3 is configured for set #1.</p> <p>Exampe: > ipf rule 3 1 -e 1 -t "i 1 3"</p>
<i>-t "c <value>"</i>	<p>It means to enable or disable the function of clearing sessions when the schedule is ON.</p> <p><value>: 0 : Disable; 1 : Enable.</p>
<i>-M <Your Comments></i>	<p>It means to set comments for the filter rule.</p> <p><Your Comments>: Enter a brief description.</p>
<i>-U "<up/down>"</i>	<p>It means to move up or move down the order of a filter rule in the filter set.</p> <p>up: It indicates move the filter rule up.</p> <p>down: It indicates move the filter rule down.</p>

Example

```
> ipf rule 3 1 -e 1 -M testtest -s "u 1 192.168.1.20" -F "0 1"
```

```

Setting saved.
> ipf rule 3 1 -v
Filter Set 3 Rule 1:

Status : Enable
Comments: testtest
Index(1-15) in Schedule Setup: <null>, <null>, <null>, <null>

Clear sessions when schedule is ON: Disable

Direction      : LAN/RT/VPN -> WAN
Src Interface  : LAN1, LAN2, LAN3, LAN4, LAN5, LAN6, LAN7, LAN8, LAN9,
LAN10, LAN11, LAN12, LAN13, LAN14, LAN15, LAN16, LAN17, LAN18, LAN19,
LAN20, LAN21, LAN22, LAN23, LAN24, LAN25, LAN26, LAN27, LAN28, LAN29,
LAN30, LAN31, LAN32, LAN33, LAN34, LAN35, LAN36, LAN37, LAN38, LAN39,
LAN40, LAN41, LAN42, LAN43, LAN44, LAN45, LAN46, LAN47, LAN48, LAN49,
LAN50, LAN51, LAN52, LAN53, LAN54, LAN55, LAN56, LAN57, LAN58, LAN59,
LAN60, LAN61, LAN62, LAN63, LAN64, LAN65, LAN66, LAN67, LAN68, LAN69,
LAN70, LAN71, LAN72, LAN73, LAN74, LAN75, LAN76, LAN77, LAN78, LAN79,
LAN80, LAN81, LAN82, LAN83, LAN84, LAN85, LAN86, LAN87, LAN88, LAN89,
LAN90, LAN91, LAN92, LAN93, LAN94, LAN95, LAN96, LAN97, LAN98, LAN99,
LAN100, Routed, VPN,

Dst Interface  : WAN1, WAN2, WAN3, WAN4, WAN5, WAN6, WAN7, WAN8, WAN9,
WAN10, WAN11, WAN12, WAN13, WAN14, WAN15, WAN16, WAN17, WAN18, WAN19,
WAN20, WAN21, WAN22, WAN23, WAN24, WAN25, WAN26, WAN27, WAN28, WAN29,
WAN30, WAN31, WAN32, WAN33, WAN34, WAN35, WAN36, WAN37, WAN38, WAN39,
WAN40, WAN41, WAN42, WAN43, WAN44, WAN45, WAN46, WAN47, WAN48, WAN49,
WAN50, WAN51, WAN52

Source IP      : 192.168.1.20
Destination IP : Any
Service Type   : Any
Fragments     : Don't Care

Pass or Block      : Pass Immediately
Branch to Other Filter Set : None
Max Sessions Limit : 300000
Current Sessions   : 0
Mac Bind IP       : Non-Strict
Qos Class         : None
Packet Capture    : Disable
APP Enforcement    : None
URL Content Filter : None
WEB Content Filter : None
DNS Filter        : None
Load-Balance policy : Auto-select
Log               : Enable

-----
CodePage          : ANSI(1252)-Latin I
Window size       : 65535
Session timeout   : 60
DrayTek Banner    : Enable
-----

```

```

Strict Security Checking
  [ ]APP Enforcement
>

```

Telnet Command: ipf flowtrack

This command is used to set and view flowtrack sessions.

Syntax

```
ipf flowtrack set <-r/-e>
```

```
ipf flowtrack view <-f/-b>
```

Syntax Description

Parameter	Description
-r	It means to refresh the flowtrack.
-e	It means to enable or disable the flowtrack.
-f	It means to show the sessions state of flowtrack. If you do not specify any IP address, then all the session state of flowtrack will be displayed.
-b	It means to show all of IP sessions state.

Example

```

> ipf flowtrack set -e
Current flowtrack ON
>

```

Telnet Command: ipf flowtest

This command is used to for RD debug in firewall diagnose.

Telnet Command: Log

This command allows users to view log for WAN interface such as call log, IP filter log, flush log buffer, etc.

Syntax

```
log [-cfhiptwx?] [-F a | c | f | w]
```

Syntax Description

Parameter	Description
-c	It means to show the latest call log.
-f	It means to show the IP filter log.
-F	It means to show the flush log buffer. a: flush all logs c: flush the call log f: flush the IP filter log

	w: flush the WAN log
-h	It means to show this usage help.
-p	It means to show PPP/MP log.
-t	It means to show all logs saved in the log buffer.
-w	It means to show WAN log.
-x	It means to show packet body hex dump.

Example

```

> log -w
25:36:25.580 ---->DHCP (WAN-5) Len = 548XID = 0x7880fdd4
    Client IP      = 0.0.0.0
    Your IP        = 0.0.0.0
    Next server IP = 0.0.0.0
    Relay agent IP = 0.0.0.0
25:36:33.580 ---->DHCP (WAN-5) Len = 548XID = 0x7880fdd4
    Client IP      = 0.0.0.0
    Your IP        = 0.0.0.0
    Next server IP = 0.0.0.0
    Relay agent IP = 0.0.0.0
25:36:41.580 ---->DHCP (WAN-5) Len = 548XID = 0x7880fdd4
    Client IP      = 0.0.0.0
    Your IP        = 0.0.0.0
    Next server IP = 0.0.0.0
    Relay agent IP = 0.0.0.0
25:36:49.580 ---->DHCP (WAN-5) Len = 548XID = 0x7880fdd4
    Client IP      = 0.0.0.0
    Your IP        = 0.0.0.0
    Next server IP = 0.0.0.0
    Relay agent IP = 0.0.0.0
25:36:57.580 ---->DHCP (WAN-5) Len = 548XID = 0x7880fdd4
    Client IP      = 0.0.0.0
    Your IP        = 0.0.0.0
--- MORE ---  ['q': Quit, 'Enter': New Lines, 'Space Bar': Next Page]
>

```

Telnet Command: ldap user

This command is used to configure the LDAP profile.

Syntax

ldap user <INDEX><OPTION>

Syntax Description

Parameter	Description
<i>INDEX</i>	Specify the index number (1 to 8) of the LDAP profile.
<i>OPTION</i>	
-n <i>VALUE</i>	Setup Profile Name.
-b <i>VALUE</i>	Setup Base Distinguished Name.

<i>-a VALUE</i>	<p>If you have added containers to be published, you may need to specify additional LDAP filters for each class of objects included in these containers.</p> <p>Creating LDAP filters is a fairly complex task that should be performed by advanced users only. LDAP filters must be RFC2254-compliant.</p> <p>For example, to exclude from publication all users who either belong to the HR department of your company or are members of the HR Group. For example:</p> <pre>>ldap user 1 -a "(!((department=HR)(memberOf=CN=HRGroup,OU=Groups,DC=acme,DC=com)))"</pre> <p>Additional Filter has been updated.</p>
<i>-g VALUE</i>	Setup Group Distinguished Name.
<i>-c VALUE</i>	Setup Common Name Identifier.
<i>-v</i>	View detail information of the LDAP profile.

Example

```
>ldap user 1 -n LD_user_test1
Profile Name has been updated!
> ldap user 1 -v
Profile Index:1
Profile Name:LD_user_test1
Common Name Identifier:
Base Distinguished Name:
Additional Filter:
Group distinguished Name:
>ldap user 1 -b ou=People,dc=example,dc=com
```

Telnet Command: ldap set

This command is used to set general settings (e.g., IP address, port number) for LDAP server.

Syntax

ldap set <Options><Value>

Syntax Description

Parameter	Description
<i>enable <0/1></i>	Enable or disable LDAP function. 0 - Disable the function. 1 - Enable the function.
<i>type <0/1/2></i>	Set the bind type as Simple(0), Anonymous(1), and Regular(2).
<i>ssl <0/1></i>	Enable or disable LDAP function via SSL tunnel. 0 - Disable the function. 1 - Enable the function.
<i>IP <VALUE></i>	Set IP address for LDAP server.
<i>port <VALUE></i>	Set port number for LDAP server.
<i>dn <VALUE></i>	Set Regular DN value
<i>PWD <VALUE></i>	Set Regular password value.

Example

```

> ldap set enable 1
> ldap enabled.
> ldap set ssl 1
LDAP with SSL has been enabled!
> ldap set IP 192.168.100.155
LDAP Server IP has been setting.
> ldap set port 389
LDAP Server Port has been setting.
> ldap set dn dc=example,dc=com
LDAP Regular DN has been setting.
> ldap set PWD 123456
LDAP Regular Password has been setting.
>

```

Telnet Command: ldap view

This command is used to check current status of LDAP settings configuration.

Syntax

ldap view

Example

```

> ldap view ?
LDAP Enable:Disabled.
LDAP Bind Type:Simple
LDAP with SSL:Disabled
LDAP Regular DN:
LDAP Regular Password:
LDAP Server IP:
LDAP Server Port:389
>

```

Telnet Command: tacacsplus set

This command allows users to configure general settings for TACACS+ server

Syntax

tacacsplus set <Options><Value>

Syntax Description

Parameter	Description
-e <0-1>	Disable (0)/enable(1) the TACACS+ server.
-i "<INDEX><IP>"	Set the IP address of the TACACS+ server. <INDEX> - Enter 0 for primary server; enter 1 for secondary server. <IP> - Enter the IP address of the server.
-p "<INDEX><port>"	Set the port number (1 to 65535) of TACACS+ server. <INDEX> - Enter 0 for primary server; enter 1 for secondary server. <port> - Enter a port number.
-s "<INDEX><secret>"	Set the Shared Secret value of TACACS+ Server. <INDEX> - Enter 0 for primary server; enter 1 for secondary server. <secret> - Enter a string.
-C <yes>	Clear the settings.

Example

```
> tacacsplus set -e 1
TACACS+ enabled!
This setting will take effect after rebooting.
Please use "sys reboot" command to reboot the router.

> tacacsplus set -i "1 192.168.1.59"
TACACS+ Server IP has been setting.
This setting will take effect after rebooting.
Please use "sys reboot" command to reboot the router.

>
```

Telnet Command: tacacsplus view

This command allows users to check the general settings for TACACS+ server

Syntax

`tacacsplus view`

Example

```
> tacacsplus view
External TACACS+ is enabled
-----

Primary Server:
Server IP Address: 0.0.0.0
Port:49
Type:ASCII
-----

Secondary Server:
Server IP Address: 192.168.1.59
Port:49
Type:ASCII
```

Telnet Command: mngt ftpport

This command allows users to set FTP port for management.

Syntax

`mngt ftpport <FTP port>`

Syntax Description

Parameter	Description
<i>FTP port</i>	It means to type the number for FTP port. The default setting is 21.

Example

```
> mngt ftpport 21
% Set FTP server port to 21 done.
```

Telnet Command: mngt httpport

This command allows users to set HTTP port for management.

Syntax

mngt httpport <Http port>

Syntax Description

Parameter	Description
<i>Http port</i>	It means to enter the number for HTTP port. The default setting is 80.

Example

```
> mngt httpport 80
% Set web server port to 80 done.
```

Telnet Command: mngt httpsport

This command allows users to set HTTPS port for management.

Syntax

mngt httpsport <Https port>

Syntax Description

Parameter	Description
<i>Https port</i>	It means to type the number for HTTPS port. The default setting is 443.

Example

```
> mngt httpsport 443
% Set web server port to 443 done.
```

Telnet Command: mngt sslvpnport

This command allows users to set SSL VPN port for management.

Syntax

mngt sslvpnport <SSL VPN port>

Syntax Description

Parameter	Description
<i>SSL VPN port</i>	It means to type the number for SSL VPN port. The default setting is 443.

Example

```
> mngt sslvpnport 443
% Set SSL VPN port to 443 done.
```

Telnet Command: mngt telnetport

This command allows users to set telnet port for management.

Syntax

mngt telnetport <Telnet port>

Syntax Description

Parameter	Description
<i>Telnet port</i>	It means to type the number for telnet port. The default setting is 23.

Example

```
> mngt telnetport 23
% Set Telnet server port to 23 done.
```

Telnet Command: mngt sshport

This command allows users to set SSH port for management.

Syntax

mngt sshport <ssh port>

Syntax Description

Parameter	Description
<i>ssh port</i>	It means to type the number for SSH port. The default setting is 22.

Example

```
> mngt sshport 23
% Set ssh port to 23 done.
```

Telnet Command: mngt noping

This command is used to pass or block Ping from LAN PC to the internet.

Syntax

mngt noping *on*

mngt noping *off*

mngt noping *viewlog*

mngt noping *clearlog*

Syntax Description

Parameter	Description
<i>on</i>	All PING packets will be forwarded from LAN PC to Internet.
<i>off</i>	All PING packets will be blocked from LAN PC to Internet.
<i>viewlog</i>	It means to display a log of ping action, including source MAC and source IP.
<i>clearlog</i>	It means to clear the log of ping action.

Example

```
> mngt noping off
No Ping Packet Out is OFF!!
```

Telnet Command: mngt defenseworm

This command can block specified port for passing through the router.

Syntax

```
mngt defenseworm on
mngt defenseworm off
mngt defenseworm add port
mngt defenseworm del port
mngt defenseworm viewlog
mngt defenseworm clearlog
```

Syntax Description

Parameter	Description
<i>on</i>	It means to activate the function of defense worm packet out.
<i>off</i>	It means to inactivate the function of defense worm packet out.
<i>add port</i>	It means to add a new TCP port for block.
<i>del port</i>	It means to delete a TCP port for block.
<i>viewlog</i>	It means to display a log of defense worm packet, including source MAC and source IP.
<i>clearlog</i>	It means to remove the log of defense worm packet.

Example

```
> mngt defenseworm add 21
Add TCP port 21
Block TCP port list: 135, 137, 138, 139, 445, 21
> mngt defenseworm del 21
Delete TCP port 21
Block TCP port list: 135, 137, 138, 139, 445
>
```

Telnet Command: mngt rmtcfg

This command can allow the system administrators to login from the Internet. By default, it is not allowed.

Syntax

```
mngt rmtcfg status
mngt rmtcfg enable
mngt rmtcfg disable
mngt rmtcfg <http/https/ftp/telnet/ssh/tr069/snmp/enforce_https><on/off>
```

Syntax Description

Parameter	Description
-----------	-------------

<i>status</i>	It means to display current setting for your reference.
<i>enable</i>	It means to allow the system administrators to login from the Internet.
<i>disable</i>	It means to deny the system administrators to login from the Internet.
<i>http/https/ftp/telnet/ssh/t r069/snmp/enforce_https</i>	It means to specify one of the servers/protocols for enabling or disabling.
<i>on/off</i>	on - enable the function. off - disable the function.

Example

```
> mngt rmtcfg ftp on
Enable server fail
Remote configure function has been disabled
please enable by enter mngt rmtcfg enable

> mngt rmtcfg enable
%% Remote configure function has been enabled.
> mngt rmtcfg ftp on
%% FTP server has been enabled.
```

Telnet Command: mngt lanaccess

This command allows users to manage accessing into Vigor router through LAN port.

Syntax

mngt lanaccess -e <0/1> -s <value> -i <value> -l <value>

mngt lanaccess -l

mngt lanaccess -E

mngt lanaccess -f

mngt lanaccess -d

mngt lanaccess -v

mngt lanaccess -h

Syntax Description

Parameter	Description
<i>-e <0/1></i>	It means to enable/disable the function. 0-disable the function. 1-enable the function.
<i>-s <value></i>	It means to specify service offered. Available values include: FTP, HTTP, HTTPS, ENFORCE_HTTPS, TELNET, SSH, None, All
<i>-i <value></i>	It means the interface which is allowed to access. Available values include: LAN1~LAN100, IP Routed Subnet, None, All Note: LAN1 is always allowed for accessing into the router.
<i>-l <value></i>	It means the IP object index allowed to access. Available values include: 1 to 500
<i>-E <0/1></i>	It means to enable the function of specific IP allowed to be access.

	0-disable the function. 1-enable the function.
<code>-f</code>	It means to flush all of the settings.
<code>-d</code>	It means to restore the factory default settings.
<code>-v</code>	It means to view current settings.
<code>-h</code>	It means to get the usage of such command.

Example

```

> mngt lanaccess -e 1 -s FTP -i LAN1 -I 1
> mngt lanaccess -v
Current LAN Access Control Setting:
* Enable:Yes
* Service:
  - FTP:Yes
  - HTTP:No
  - HTTPS:No
  - TELNET:No
  - SSH:No
  - TR069:No
  - Enforce HTTPS:No
* Subnet:
  - LAN 1: enabled
    - Specific IP(type:IP Object)(index:1) is disabled
  - LAN 2: disabled
    - Specific IP(type:IP Object)(index:0) is disabled
  - LAN 3: disabled
    - Specific IP(type:IP Object)(index:0) is disabled
  - LAN 4: disabled
    - Specific IP(type:IP Object)(index:0) is disabled
  - LAN 5: disabled
    - Specific IP(type:IP Object)(index:0) is disabled
  - LAN 6: disabled
    - Specific IP(type:IP Object)(index:0) is disabled
  - LAN 7: disabled
    - Specific IP(type:IP Object)(index:0) is disabled
  - LAN 8: disabled
    - Specific IP(type:IP Object)(index:0) is disabled
  - LAN 9: disabled
    - Specific IP(type:IP Object)(index:0) is disabled
  ...
  ...
  - LAN 100: disabled
    - Specific IP(type:IP Object)(index:0) is disabled
  - IP Routed Subnet: disabled
    - Specific IP(type:IP Object)(index:0) is disabled

```

Telnet Command: `mngt echoicmp`

This command allows users to reject or accept PING packets from the Internet.

Syntax

mngt echoicmp *enable*

mngt echoicmp *disable*

Syntax Description

Parameter	Description
<i>enable</i>	It means to accept the echo ICMP packet.
<i>disable</i>	It means to drop the echo ICMP packet.

Example

```
> mngt echoicmp enable
%% Echo ICMP packet enabled.
```

Telnet Command: mngt accesslist

This command allows you to specify that the system administrator can login from a specific host or network. A maximum of ten IPs/subnet masks is allowed.

Syntax

mngt accesslist *list*

mngt accesslist *add* <IP/Hostname><No.><Index>

mngt accesslist *remove* <index>

mngt accesslist *flush*

Syntax Description

Parameter	Description
<i>list</i>	It can display current setting for your reference.
<i>add</i>	It means adding a new entry.
<i>IP/Hostname</i>	It means to specify the IP object or the name of the host. Available settings: <ul style="list-style-type: none">● IP● hostname
<i>No.</i>	A maximum of 10 IP objects are allowed to be assigned.
<i>index</i>	It means the index number (1 to 192) of the IP objects preconfigured.
<i>remove</i>	It means to delete the selected item.
<i>flush</i>	It means to remove all the settings in the access list.

Example

```
> mngt accesslist add ip 1 1
%% Set OK. Please do "sys re" to reboot the router!
> mngt accesslist list
%% Access list :
  [NO.]      [Type]      [Index]      [Description]
=====
====
  1          IP Object  1            Please setting index=1 for IP Object
>
```

Telnet Command: mngt wanlogin

This command allows you to enable or disable WAN login function.

Syntax

mngt wanlogin *enable*

mngt wanlogin *disable*

Example

```
> mngt wanlogin enable
%% wan login enabled.
>
```

Telnet Command: mngt snmp

This command allows you to configure SNMP for management.

Syntax

mngt snmp [-<command> <parameter> | ...]

Syntax Description

Parameter	Description
[<command> <parameter> ...]	The available commands with parameters are listed below. [...] means that you can type in several commands in one line.
-e <1/2>	1: Enable the SNMP function. 2: Disable the SNMP function.
-a <1/2>	1: Enable the SNMPV1 function. 2: Disable the SNMPV1 function.
-b <1/2>	1: Enable the SNMPV2C function. 2: Disable the SNMPV2C function.
-c <1/2>	1: Enable the SNMPV3 function. 2: Disable the SNMPV3 function.
-g <Community name>	It means to set the name for getting community by typing a proper character. (max. 23 characters)
-s <Community name>	It means to set community by typing a proper name. (max. 23 characters)
-m <IP address>	It means to set one host as the manager to execute SNMP function. Please type in IPv4 address to specify certain host. It allows to set 3 IPs, separated by ",".
-t <Community name>	It means to set trap community by typing a proper name. (max. 23 characters)
-n <IP address>	It means to set the notification host. It allows to set 2 IPs, separated by ",".
-T <seconds>	It means to set the trap timeout <0-999>.
-o <username>	It means to set a user account (maximum 23 characters) for user management.
-p <0/1/2>	It means to set the authentication algorithm. 0: No auth 1: MD5_AUTH 2: SHA_AUTH
-q <password>	It means to set the password (maximum 23 characters) for authentication.
-r <0,3/4/6>	It means to set privacy algorithm 0, 3: No_PRIV 4: DES_PRIV 6: AES_PRIV
-u <password>	It means to set the password (maximum 23 characters) for privacy.
-V	It means to list SNMP setting.

Example

```
> mngt snmp -e 1 -g draytek -s DK -m 192.168.1.1 -t trapcom -n 10.20.3.40
```

```

-T 88
SNMP Agent Turn on!!!
Get Community set to draytek
Set Community set to DK
Manager Host IP set to 192.168.1.1
Trap Community set to trapcom
Notification Host IP set to 10.20.3.40
Trap Timeout set to 88 seconds
>

```

Telnet Command: mngt bfp

This command allows you to configure brute force protect (BFP) for system management.

Syntax

mngt bfp [*<command><parameter>/...*]

Syntax Description

Parameter	Description
[<i><command><parameter>/...</i>]	The available commands with parameters are listed below. [<i>...</i>] means that you can type in several commands in one line.
-e 0/1	Enable / disable the BFP function. 0 - Disable 1 - Enable
-s <i><service></i>	It means to enable different service. service - Available types are FTP, HTTP, HTTPS, TELNET, TR069, SSH, VPN, None and All.
-l <i><failure></i>	It means to set login failure retry times. failure - Available number is from 1 to 255.
-p <i><penalty></i>	It means to set penalty time for BFP. The unit is sec.
-v	It means to view current settings.

Example

```

> mngt bfp -e 1
> mngt bfp -s FTP
> mngt bfp -l 10
> mngt bfp -v
Current Brute Force Protection Setting:
* Enable: yes
* Service:
- FTP:      yes
- HTTP:     no
- HTTPS:    no
- TELNET:   no
- TR069:    no
- SSH:      no
* Maximum login failures: 10
* Penalty period: 0

```

Telnet Command: mngt cert_import

This command allows you to import a certificate to Vigor router.

Syntax

mngt cert_import local_cert <URL> <password>

mngt cert_import trusted_ca <URL>

Syntax Description

Parameter	Description
<i>local_cert url</i> <URL> <password>	URL - Enter a URL(http://...) for downloading the certificate. The file is encrypted with the file format of "xxxx.p12". Password - Enter the password for decrypting the .p12 certificate.
<i>trusted_ca</i> <URL>	URL - Enter a URL(http://...) for downloading the certificate. The file is encrypted with the file format of "xxxx.p12".

Telnet Command: mngt telnettimeout

This command allows you to configure the timeout for telnet connection.

Syntax

mngt telnettimeout <value>

Syntax Description

Parameter	Description
<value>	Range from 60 to 300. The default value is 300 (seconds).

Example

```
> mngt telnettimeout 100
% Telnet timeout : 100s
>
```

Telnet Command: mngt ssttimeout

This command allows you to configure the timeout for SSH connection.

Syntax

mngt ssttimeout <value>

Syntax Description

Parameter	Description
<value>	Range from 60 to 300. The default value is 300 (seconds).

Example

```
> mngt ssttimeout 200
% SSH timeout : 200s
>
```

Telnet Command: mngt ip6_IIDs

This command allows you to configure the IPv6 interface ID.

Syntax

mngt ip6-IIDs -e <val>>

mngt ip6_IIDs -r <interface>

mngt ip6_IIDs -s

Syntax Description

Parameter	Description
-e <value>	It is used to determine the way of generating IPv6 interface id. val = 0 : Use EUI-64 IIDs as interface id val = 1 : Use Random IIDs as interface id
-r <interface>	It is used to re-generate the random IIDs of the specified interface. interface = LAN1 LAN2 ... WAN1 WAN2 ...
-s	Displays the random IIDs for each interface.

Example

```
> mngt ip6_IIDs -e 1
% Setting success, the change will take effect after router rebooting.
> mngt ip6_IIDs -r LAN1
% Setting success, the change will take effect after router rebooting.
> mngt ip6_IIDs -s
% LAN IIDs = 98bd:38a0:7242:a84f
% WAN1 IIDs = 0b35:32cd:f1b5:0af0
% WAN2 IIDs = f018:7f99:830f:8067
% WAN3 IIDs = 5c05:9272:e383:9cce
% WAN4 IIDs = 8bfc:e800:7cdc:32ec
% WAN5 IIDs = c5f8:59d6:bbca:46ce
% WAN6 IIDs = 496b:da9f:e260:9e45
% WAN7 IIDs = 1c87:a3e2:1724:cec9
% WAN8 IIDs = 8aa4:2546:cbde:e1c6
% WAN9 IIDs = 814e:74f0:535b:90a5
% WAN10 IIDs = f9e9:dfeb:0626:2a30
>
```

Telnet Command: msubnet switch

This command is used to configure multi-subnet.

Syntax

msubnet switch

<2/3/4/5/6/7/8/9/10/11/12/13/14/15/16/17/18/19/20/21/22/23/24/25/26/27/28/29/30/31/32/33/34/35/36/37/38/39/40/41/42/43/44/45/46/47/48/49/50/51/52/53/54/55/56/57/58/59/60/61/62/63/64/65/66/67/68/69/70/71/72/73/74/75/76/77/78/79/80/81/82/83/84/85/86/87/88/89/90/91/92/93/94/95/96/97/98/99/100> <On/Off>

Syntax Description

Parameter	Description
<2/3/4/5/6/7/8/9/10/11/12/13/14/15/16/17/18/19/20/21/22/23/24/25/26/27/28/29/30/31/32/33/34/35/36/37/38/39/40/41/42/43/44/45/46/47/48/49/50/51/52/53/54/55/56/57/58/59/60/61/62/63/64/65/66/67/68/69/70/71/72/73/74/75/76/77/78/79/80/81/82/83/84/85/86/87/88/89/90/91/92/93/94/95/96/97/98/99/100>	It means LAN interface. 2=LAN2 3=LAN3 4=LAN4 5=LAN5 6=LAN6 100=LAN100
<On/Off>	On means turning on the subnet for the specified LAN interface. Off means turning off the subnet.

Example

```
> msubnet switch 99 On
% LAN2          Subnet On!
```

This setting will take effect after rebooting.
Please use "sys reboot" command to reboot the router.

Telnet Command: msubnet addr

This command is used to configure IP address for the specified LAN interface.

Syntax

msubnet addr

```
<2/3/4/5/6/7/8/9/10/11/12/13/14/15/16/17/18/19/20/21/22/23/24/25/26/27/28/29/30/31/32/33/34/35/36/37/38/39/40/41/42/43/44/45/46/47/48/49/50/51/52/53/54/55/56/57/58/59/60/61/62/63/64/65/66/67/68/69/70/71/72/73/74/75/76/77/78/79/80/81/82/83/84/85/86/87/88/89/90/91/92/93/94/95/96/97/98/99/100> <IP address>
```

Syntax Description

Parameter	Description
<2/3/4/5/6/7/8/9/10/11/12/13/14/15/16/17/18/19/20/21/22/23/24/25/26/27/28/29/30/31/32/33/34/35/36/37/38/39/40/41/42/43/44/45/46/47/48/49/50/51/52/53/54/55/56/57/58/59/60/61/62/63/64/65/66/67/68/69/70/71/72/73/74/75/76/77/78/79/80/81/82/83/84/85/86/87/88/89/90/91/92/93/94/95/96/97/98/99/100>	It means LAN interface. 2=LAN2 3=LAN3 4=LAN4 5=LAN5 6=LAN6 100=LAN100
<IP address>	Type the private IP address for the specified LAN interface.

Example

```
> msubnet addr 2 192.168.5.1
% Set LAN2 subnet IP address done !!!

This setting will take effect after rebooting.
Please use "sys reboot" command to reboot the router.
```

Telnet Command: msubnet nmask

This command is used to configure net mask address for the specified LAN interface.

Syntax

msubnet nmask

```
<2/3/4/5/6/7/8/9/10/11/12/13/14/15/16/17/18/19/20/21/22/23/24/25/26/27/28/29/30/31/32/33/34/35/36/37/38/39/40/41/42/43/44/45/46/47/48/49/50/51/52/53/54/55/56/57/58/59/60/61/62/63/64/65/66/67/68/69/70/71/72/73/74/75/76/77/78/79/80/81/82/83/84/85/86/87/88/89/90/91/92/93/94/95/96/97/98/99/100> <IP address>
```

Syntax Description

Parameter	Description
<2/3/4/5/6/7/8/9/10/11/12/13/14/15/16/17/18/19/20/21/22/23/24/25/26/27/28/29/30/31/32/33/34/35/36/37/38/39/40/41/42/43/44/45/46/47/48/49/50/51/52/53/54/55/56/57/58/59/60/61/62/63/64/65/66/67/68/69/70/71/72/73/74/75/76/77/78/79/80/81/82/83/84/85/86/87/88/89/90/91/92/93/94/95/96/97/98/99/100>	It means LAN interface. 2=LAN2 3=LAN3 4=LAN4 5=LAN5 6=LAN6 100=LAN100
<IP address>	Type the subnet mask address for the specified LAN interface.

Example

```
> msubnet nmask 2 255.255.0.0
% Set 3/44/45/46/47/48/49/50 subnet mask done !!!

This setting will take effect after rebooting.
Please use "sys reboot" command to reboot the router.
```

Telnet Command: msubnet status

This command is used to display current status of subnet.

Syntax

msubnet status

```
<2/3/4/5/6/7/8/9/10/11/12/13/14/15/16/17/18/19/20/21/22/23/24/25/26/27/28/29/30/31/32/33/34/35/36/37/38/39/40/41/42/43/44/45/46/47/48/49/50/51/52/53/54/55/56/57/58/59/60/61/62/63/64/65/66/67/68/69/70/71/72/73/74/75/76/77/78/79/80/81/82/83/84/85/86/87/88/89/90/91/92/93/94/95/96/97/98/99/100>
```

Syntax Description

Parameter	Description
-----------	-------------

<2/3/4/5/6/7/8/9/10/11/12/13/14/15/16/17/18/19/20/21/22/23/24/25/26/27/28/29/30/31/32/33/34/35/36/37/38/39/40/41/42/43/44/45/46/47/48/49/50/51/52/53/54/55/56/57/58/59/60/61/62/63/64/65/66/67/68/69/70/71/72/73/74/75/76/77/78/79/80/81/82/83/84/85/86/87/88/89/90/91/92/93/94/95/96/97/98/99/100>	It means LAN interface. 2=LAN2 3=LAN3 4=LAN4 5=LAN5 6=LAN6 100=LAN100
---	---

Example

```
> msubnet status 2
% LAN2      Off: 0.0.0.0/0.0.0.0, PPP Start IP: 0.0.0.60
% DHCP server: Off
% Dhcp Gateway: 0.0.0.0, Start IP: 0.0.0.10, Pool Count: 50
```

Telnet Command: msubnet dhcps

This command allows you to enable or disable DHCP server for the subnet.

Syntax

msubnet dhcps

```
<2/3/4/5/6/7/8/9/10/11/12/13/14/15/16/17/18/19/20/21/22/23/24/25/26/27/28/29/30/31/32/33/34/35/36/37/38/39/40/41/42/43/44/45/46/47/48/49/50/51/52/53/54/55/56/57/58/59/60/61/62/63/64/65/66/67/68/69/70/71/72/73/74/75/76/77/78/79/80/81/82/83/84/85/86/87/88/89/90/91/92/93/94/95/96/97/98/99/100> <On/Off>
```

Syntax Description

Parameter	Description
<2/3/4/5/6/7/8/9/10/11/12/13/14/15/16/17/18/19/20/21/22/23/24/25/26/27/28/29/30/31/32/33/34/35/36/37/38/39/40/41/42/43/44/45/46/47/48/49/50/51/52/53/54/55/56/57/58/59/60/61/62/63/64/65/66/67/68/69/70/71/72/73/74/75/76/77/78/79/80/81/82/83/84/85/86/87/88/89/90/91/92/93/94/95/96/97/98/99/100>	It means LAN interface. 2=LAN2 3=LAN3 4=LAN4 5=LAN5 6=LAN6 100=LAN100
<On/Off>	On means enabling the DHCP server for the specified LAN interface. Off means disabling the DHCP server.

Example

```
> msubnet dhcps 3 off
% LAN3      Subnet DHCP Server disabled!

This setting will take effect after rebooting.
Please use "sys reboot" command to reboot the router.
```

Telnet Command: msubnet nat

This command is used to configure the subnet for NAT or Routing usage.

Syntax

msubnet nat

```
<2/3/4/5/6/7/8/9/10/11/12/13/14/15/16/17/18/19/20/21/22/23/24/25/26/27/28/29/30/31/32/33/34/35/36/37/38/39/40/41/42/43/44/45/46/47/48/49/50/51/52/53/54/55/56/57/58/59/60/61/62/63/64/65/66/67/68/69/70/71/72/73/74/75/76/77/78/79/80/81/82/83/84/85/86/87/88/89/90/91/92/93/94/95/96/97/98/99/100> <On/Off>
```

Syntax Description

Parameter	Description
<2/3/4/5/6/7/8/9/10/11/12/13/14/15/16/17/18/19/20/21/22/23/24/25/26/27/28/29/30/31/32/33/34/35/36/37/38/39/40/41/42/43/44/45/46/47/48/49/50/51/52/53/54/55/56/57/58/59/60/61/62/63/64/65/66/67/68/69/70/71/72/73/74/75/76/77/78/79/80/81/82/83/84/85/86/87/88/89/90/91/92/93/94/95/96/97/98/99/100>	It means LAN interface. 2=LAN2 3=LAN3 4=LAN4 5=LAN5 6=LAN6 100=LAN100
<On/Off>	On - It means the subnet will be configured for NAT usage. Off - It means the subnet will be configured for Routing usage.

Example

```
> > ms subnet nat 2 off
% LAN2 Subnet is for Routing usage!
%Note: If you have multiple WAN connections, please be reminded to setup
a Load-Balance policy so that packets from this subnet will be forwarded
to the right WAN interface!

This setting will take effect after rebooting.
Please use "sys reboot" command to reboot the router.
```

Telnet Command: ms subnet gateway

This command is used to configure an IP address as the gateway used for subnet.

Syntax

msubnet gateway

```
<2/3/4/5/6/7/8/9/10/11/12/13/14/15/16/17/18/19/20/21/22/23/24/25/26/27/28/29/30/31/32/33/34/35/36/37/38/39/40/41/42/43/44/45/46/47/48/49/50/51/52/53/54/55/56/57/58/59/60/61/62/63/64/65/66/67/68/69/70/71/72/73/74/75/76/77/78/79/80/81/82/83/84/85/86/87/88/89/90/91/92/93/94/95/96/97/98/99/100> <Gateway IP>
```

Syntax Description

Parameter	Description
<2/3/4/5/6/7/8/9/10/11/12/13/14/15/16/17/18/19/20/21/22/23/24/25/26/27/28/29/30/31/32/33/34/35/36/37/38/39/40/41/42/43/44/45/46/47/48/49/50/51/52/53/54/55/56/57/58/59/60/61/62/63/64/65/66/67/68/69/70/71/72/73/74/75/76/77/78/79/80/81/82/83/84/85/86/87/88/89/90/91/92/93/94/95/96/97/98/99/100>	It means LAN interface. 2=LAN2 3=LAN3 4=LAN4

2/53/54/55/56/57/58/59/60/61/62/63/64/65/66/67/68/69/70/71/72/73/74/75/76/77/78/79/80/81/82/83/84/85/86/87/88/89/90/91/92/93/94/95/96/97/98/99/100>	5=LAN5 6=LAN6 100=LAN100
<Gateway IP>	Specify an IP address as the gateway IP.

Example

```
> msubnet gateway 2 192.168.1.13
% Set LAN2 Dhcp Gateway IP done !!!

This setting will take effect after rebooting.
Please use "sys reboot" command to reboot the router.
```

Telnet Command: msubnet ipcnt

This command is used to defined the total number allowed for each LAN interface.

Syntax

msubnet ipcnt

```
<2/3/4/5/6/7/8/9/10/11/12/13/14/15/16/17/18/19/20/21/22/23/24/25/26/27/28/29/30/31/32/33/34/35/36/37/38/39/40/41/42/43/44/45/46/47/48/49/50/51/52/53/54/55/56/57/58/59/60/61/62/63/64/65/66/67/68/69/70/71/72/73/74/75/76/77/78/79/80/81/82/83/84/85/86/87/88/89/90/91/92/93/94/95/96/97/98/99/100> <IP counts>
```

Syntax Description

Parameter	Description
<2/3/4/5/6/7/8/9/10/11/12/13/14/15/16/17/18/19/20/21/22/23/24/25/26/27/28/29/30/31/32/33/34/35/36/37/38/39/40/41/42/43/44/45/46/47/48/49/50/51/52/53/54/55/56/57/58/59/60/61/62/63/64/65/66/67/68/69/70/71/72/73/74/75/76/77/78/79/80/81/82/83/84/85/86/87/88/89/90/91/92/93/94/95/96/97/98/99/100>	It means LAN interface. 2=LAN2 3=LAN3 4=LAN4 5=LAN5 6=LAN6 100=LAN100
<IP counts>	Specify a total number of IP address allowed for each LAN interface. The available range is from 0 to 220.

Example

```
> msubnet ipcnt 2 15
This setting will take effect after rebooting.
Please use "sys reboot" command to reboot the router.
```

Telnet Command: msubnet talk

This command is used to establish a route between two LAN interfaces.

Syntax

msubnet talk

```
<1/2/3/4/5/6/7/8/9/10/11/12/13/14/15/16/17/18/19/20/21/22/23/24/25/26/27/28/29/30/31/32/33/34/35/36/37/38/39/40/41/42/43/44/45/46/47/48/49/50/51/52/53/54/55/56/57/58/59/60/61/62/63/64/65/66/67/68/69/70/71/72/73/74/75/76/77/78/79/80/81/82/83/84/85/86/87/88/89/90/91/92/93/94/95/96/97/98/99/100>  
<1/2/3/4/5/6/7/8/9/10/11/12/13/14/15/16/17/18/19/20/21/22/23/24/25/26/27/28/29/30/31/32/33/34/35/36/37/38/39/40/41/42/43/44/45/46/47/48/49/50/51/52/53/54/55/56/57/58/59/60/61/62/63/64/65/66/67/68/69/70/71/72/73/74/75/76/77/78/79/80/81/82/83/84/85/86/87/88/89/90/91/92/93/94/95/96/97/98/99/100> <On/Off>
```

Syntax Description

Parameter	Description
<1/2/3/4/5/6/7/8/9/10/11/12/13/14/15/16/17/18/19/20/21/22/23/24/25/26/27/28/29/30/31/32/33/34/35/36/37/38/39/40/41/42/43/44/45/46/47/48/49/50/51/52/53/54/55/56/57/58/59/60/61/62/63/64/65/66/67/68/69/70/71/72/73/74/75/76/77/78/79/80/81/82/83/84/85/86/87/88/89/90/91/92/93/94/95/96/97/98/99/100>	It means LAN interface. 1=LAN1 2=LAN2 3=LAN3 4=LAN4 5=LAN5 6=LAN6 100=LAN100
On/Off	On - It means to enable the function. Off - It means to disable the function.

Example

```
> ms subnet talk 1 2 on  
  
% Enable routing between LAN1          and LAN2          !  
  
This setting will take effect after rebooting.  
Please use "sys reboot" command to reboot the router.  
> ms subnet talk ?  
% ms subnet talk <1/../../100> <1/../../100> <On/Off>  
% where 1:LAN1, 2:LAN2, 3:LAN3, 4:LAN4, 5:LAN5, 6:LAN6: .....  
% Now:  
%          LAN1  LAN2  LAN3  LAN4  LAN5  LAN6  
% LAN1          V  
% LAN2          V    V  
% LAN3                    V  
% LAN4                      V  
% LAN5                        V  
% LAN6                          V  
...
```

Telnet Command: ms subnet startip

This command is used to configure a starting IP address for DHCP.

Syntax

ms subnet startip

```
<2/3/4/5/6/7/8/9/10/11/12/13/14/15/16/17/18/19/20/21/22/23/24/25/26/27/28/29/30
```

/31/32/33/34/35/36/37/38/39/40/41/42/43/44/45/46/47/48/49/50/51/52/53/54/55/56/
 57/58/59/60/61/62/63/64/65/66/67/68/69/70/71/72/73/74/75/76/77/78/79/80/81/82/8
 3/84/85/86/87/88/89/90/91/92/93/94/95/96/97/98/99/100> <Gateway IP>

Syntax Description

Parameter	Description
<2/3/4/5/6/7/8/9/10/11/1 2/13/14/15/16/17/18/19/2 0/21/22/23/24/25/26/27/2 8/29/30/31/32/33/34/35/3 6/37/38/39/40/41/42/43/4 4/45/46/47/48/49/50/51/5 2/53/54/55/56/57/58/59/6 0/61/62/63/64/65/66/67/6 8/69/70/71/72/73/74/75/7 6/77/78/79/80/81/82/83/8 4/85/86/87/88/89/90/91/9 2/93/94/95/96/97/98/99/1 00>	It means LAN interface. 2=LAN2 3=LAN3 4=LAN4 5=LAN5 6=LAN6 100=LAN100
<Gateway IP>	Type an IP address as the starting IP address for a subnet.

Example

```
> msubnet startip 2 192.168.2.90
% Set
78/79/80/81/82/83/84/85/86/87/88/89/90/91/92/93/94/95/96/97/98/99
/100 Dhcp
Start IP done !!!

This setting will take effect after rebooting.
Please use "sys reboot" command to reboot the router.

> msubnet startip ?
% msubnet startip
<2/3/4/5/6/7/8/9/10/11/12/13/14/15/16/17/18/19/20/21/22/23/24/
25/26/27/28/29/30/31/32/33/34/35/36/37/38/39/40/41/42/43/44/45/46
/47/48/49/50/51/52/53/54/55/56/57/58/59/60/61/62/63/64/65/66/67/6
8/69/70/71/72/73/74/75/76/77/78/79/80/81/82/83/84/85/86/87/88/89/
90/91/92/93/94/95/96/97/98/99/100> <Gateway IP>

% Now:
78/79/80/81/82/83/84/85/86/87/88/89/90/91/92/93/94/95/96/97/98/99
/100 192.168.2.90;
82/83/84/85/86/87/88/89/90/91/92/93/94/95/96/97/98/99/100
192.168.3.10; 86/87/88/89/90/91/92/93/94/95/96/97/98/99/100
192.168.4.10; 90/91/92/93/94/95/96/97/98/99/100 192.168.5.10;
94/95/96/97/98/99/100 192.168.6.10; 98/99/100 192.168.7.10;
192.168.8.10; 192.168.9.10; 192.168.10.10; 192.168.11.10;
192.168.12.10; 192.168.13.10; 192.168.14.10; 192.168.15.10;
192.168.16.10; 192.168.17.10; 192.168.18.10; 192.168.19.10;
192.168.20.10; 192.168.21.10; 192.168.22.10; 192.168.23.10;
192.168.24.10; 192.168.25.10; 192.168.26.10; 192.168.27.10;
192.168.28.10; 192.168.29.10; 192.168.30.10; 192.168.31.10;
192.168.32.10; 192.168.33.10; 192.168.34.10; 192.168.35.10;
192.168.36.10; 192.168.37.10; 192.168.38.10; 192.168.39.10;
192.168.40.10; 192.168.41.10; 192.168.42.10; 192.168.43.10;
192.168.44.10; 192.168.45.10; 192.168.46.10; 192.168.47.10;
192.168.48.10; 192.168.49.10; 192.168.50.10; 192.168.51.10;
192.168.52.10; 192.168.53.10; 192.168.54.10; 192.168.55.10;
192.168.56.10; 192.168.57.10; 192.168.58.10; 192.168.59.10;
```

```

192.168.60.10; 192.168.61.10; 192.168.62.10; 192.168.63.10;
192.168.64.10; 192.168.65.10; 192.168.66.10; 192.168.67.10;
192.168.68.10; 192.168.69.10; 192.168.70.10; 192.168.71.10;
192.168.72.10; 192.168.73.10; 192.168.74.10; 192.168.75.10;
192.168.76.10; 192.168.77.10; 192.168.78.10; 192.168.79.10;
192.168.80.10; 192.168.81.10; 192.168.82.10; 192.168.83.10;
192.168.84.10; 192.168.85.10; 192.168.86.10; 192.168.87.10;
192.168.88.10; 192.168.89.10; 192.168.90.10; 192.168.91.10;
192.168.92.10; 192.168.93.10; 192.168.94.10; 192.168.95.10;
192.168.96.10; 192.168.97.10; 192.168.98.10; 192.168.99.10;
192.168.101.10
>

```

Telnet Command: msubnet pppip

This command is used to configure a starting IP address for PPP connection.

Syntax

msubnet pppip

```

<2/3/4/5/6/7/8/9/10/11/12/13/14/15/16/17/18/19/20/21/22/23/24/25/26/27/28/29/30
/31/32/33/34/35/36/37/38/39/40/41/42/43/44/45/46/47/48/49/50/51/52/53/54/55/56/
57/58/59/60/61/62/63/64/65/66/67/68/69/70/71/72/73/74/75/76/77/78/79/80/81/82/8
3/84/85/86/87/88/89/90/91/92/93/94/95/96/97/98/99/100> <Start IP>

```

Syntax Description

Parameter	Description
<2/3/4/5/6/7/8/9/10/11/12/13/14/15/16/17/18/19/20/21/22/23/24/25/26/27/28/29/30/31/32/33/34/35/36/37/38/39/40/41/42/43/44/45/46/47/48/49/50/51/52/53/54/55/56/57/58/59/60/61/62/63/64/65/66/67/68/69/70/71/72/73/74/75/76/77/78/79/80/81/82/83/84/85/86/87/88/89/90/91/92/93/94/95/96/97/98/99/100>	It means LAN interface. 2=LAN2 3=LAN3 4=LAN4 5=LAN5 6=LAN6 100=LAN100
<Start IP>	Type an IP address as the starting IP address for PPP connection.

Example

```

> msubnet pppip 2 192.168.2.250
% Set
78/79/80/81/82/83/84/85/86/87/88/89/90/91/92/93/94/95/96/97/98/99
/100 PPP(IPCP) Start IP done !!!

This setting will take effect after rebooting.
Please use "sys reboot" command to reboot the router.

> msubnet pppip
% msubnet pppip
<2/3/4/5/6/7/8/9/10/11/12/13/14/15/16/17/18/19/20/21/22/23/24/25/
26/27/28/29/30/31/32/33/34/35/36/37/38/39/40/41/42/43/44/45/46/47
/48/49/50/51/52/53/54/55/56/57/58/59/60/61/62/63/64/65/66/67/68/6
9/70/71/72/73/74/75/76/77/78/79/80/81/82/83/84/85/86/87/88/89/90/
91/92/93/94/95/96/97/98/99/100> <Start IP>

```

```

% Now:
78/79/80/81/82/83/84/85/86/87/88/89/90/91/92/93/94/95/96/97/98/99
/100 192.168.2.250;
82/83/84/85/86/87/88/89/90/91/92/93/94/95/96/97/98/99/100
192.168.3.200; 86/87/88/89/90/91/92/93/94/95/96/97/98/99/100
192.168.4.200; 90/91/92/93/94/95/96/97/98/99/100 192.168.5.200;
94/95/96/97/98/99/100 192.168.6.200; 98/99/100 192.168.7.200;
192.168.8.200; 192.168.9.200; 192.168.10.200; 192.168.11.200;
192.168.12.200; 192.168.13.200; 192.168.14.200; 192.168.15.200;
192.168.16.200; 192.168.17.200; 192.168.18.200; 192.168.19.200;
192.168.20.200; 192.168.21.200; 192.168.22.200; 192.168.23.200;
192.168.24.200; 192.168.25.200; 192.168.26.200; 192.168.27.200;
192.168.28.200; 192.168.29.200; 192.168.30.200; 192.168.31.200;
192.168.32.200; 192.168.33.200; 192.168.34.200; 192.168.35.200;
192.168.36.200; 192.168.37.200; 192.168.38.200; 192.168.39.200;
192.168.40.200; 192.168.41.200; 192.168.42.200; 192.168.43.200;
192.168.44.200; 192.168.45.200; 192.168.46.200; 192.168.47.200;
192.168.48.200; 192.168.49.200; 192.168.50.200; 192.168.51.200;
192.168.52.200; 192.168.53.200; 192.168.54.200; 192.168.55.200;
192.168.56.200; 192.168.57.200; 192.168.58.200; 192.168.59.200;
192.168.60.200; 192.168.61.200; 192.168.62.200; 192.168.63.200;
192.168.64.200; 192.168.65.200; 192.168.66.200; 192.168.67.200;
192.168.68.200; 192.168.69.200; 192.168.70.200; 192.168.71.200;
192.168.72.200; 192.168.73.200; 192.168.74.200; 192.168.75.200;
192.168.76.200; 192.168.77.200; 192.168.78.200; 192.168.79.200;
192.168.80.200; 192.168.81.200; 192.168.82.200; 192.168.83.200;
192.168.84.200; 192.168.85.200; 192.168.86.200; 192.168.87.200;
192.168.88.200; 192.168.89.200; 192.168.90.200; 192.168.91.200;
192.168.92.200; 192.168.93.200; 192.168.94.200; 192.168.95.200;
192.168.96.200; 192.168.97.200; 192.168.98.200; 192.168.99.200;
192.168.101.200
>

```

Telnet Command: msubnet nodetype

This command is used to specify the type for node which is required by DHCP option.

Syntax

msubnet nodetype

```

<2/3/4/5/6/7/8/9/10/11/12/13/14/15/16/17/18/19/20/21/22/23/24/25/26/27/28/29/30
/31/32/33/34/35/36/37/38/39/40/41/42/43/44/45/46/47/48/49/50/51/52/53/54/55/56/
57/58/59/60/61/62/63/64/65/66/67/68/69/70/71/72/73/74/75/76/77/78/79/80/81/82/8
3/84/85/86/87/88/89/90/91/92/93/94/95/96/97/98/99/100> <count>

```

Syntax Description

Parameter	Description
<2/3/4/5/6/7/8/9/10/11/12/13/14/15/16/17/18/19/20/21/22/23/24/25/26/27/28/29/30/31/32/33/34/35/36/37/38/39/40/41/42/43/44/45/46/47/48/49/50/51/52/53/54/55/56/57/58/59/60/61/62/63/64/65/66/67/68/69/70/71/72/73/74/75/76/77/78/79/80/81/82/83/84/85/86/87/88/89/90/91/92/93/94/95/96/97/98/99/100>	It means LAN interface. 2=LAN2 3=LAN3 4=LAN4 5=LAN5 6=LAN6 100=LAN100
<count>	Choose the following number for specifying different node type.

	1= B-node
	2= P-node
	4= M-node
	8= H-node
	0= Not specify any type for node.

Example

```

> msubnet nodetype 2 1
% Set
78/79/80/81/82/83/84/85/86/87/88/89/90/91/92/93/94/95/96/97/98/99/
100 Dhcp
Node Type done !!!

> msubnet nodetype ?

% msubnet nodetype
<2/3/4/5/6/7/8/9/10/11/12/13/14/15/16/17/18/19/20/21/22/23/24/25/2
6/27/28/29/30/31/32/33/34/35/36/37/38/39/40/41/42/43/44/45/46/47/4
8/49/50/51/52/53/54/55/56/57/58/59/60/61/62/63/64/65/66/67/68/69/7
0/71/72/73/74/75/76/77/78/79/80/81/82/83/84/85/86/87/88/89/90/91/9
2/93/94/95/96/97/98/99/100> <count>

% Now:
78/79/80/81/82/83/84/85/86/87/88/89/90/91/92/93/94/95/96/97/98/99/
100 1;82/83/84/85/86/87/88/89/90/91/92/93/94/95/96/97/98/99/100 0;
86/87/88/89/90/91/92/93/94/95/96/97/98/99/100 0;
90/91/92/93/94/95/96/97/98/99/100 0; 94/95/96/97/98/99/100 0;
98/99/100 0; 0; 0; 0; 0; 0; 0; 0; 0; 0; 0; 0; 0; 0; 0; 0; 0; 0;
0; 0; 0; 0; 0; 0; 0; 0; 0; 0; 0; 0; 0; 0; 0; 0; 0; 0; 0; 0;
0; 0; 0; 0; 0; 0; 0; 0; 0; 0; 0; 0; 0; 0; 0; 0; 0; 0; 0; 0;
0; 0; 0; 0; 0; 0; 0; 0; 0; 0; 0; 0; 0; 0; 0; 0; 0; 0; 0; 0;
0; 0; 0; 0; 0; 0

% count: 1. B-node 2. P-node 4. M-node 8. H-node

```

Telnet Command: msubnet primWINS

This command is used to configure primary WINS server.

Syntax

msubnet primWINS

```

<2/3/4/5/6/7/8/9/10/11/12/13/14/15/16/17/18/19/20/21/22/23/24/25/26/27/28/29/30
/31/32/33/34/35/36/37/38/39/40/41/42/43/44/45/46/47/48/49/50/51/52/53/54/55/56/
57/58/59/60/61/62/63/64/65/66/67/68/69/70/71/72/73/74/75/76/77/78/79/80/81/82/8
3/84/85/86/87/88/89/90/91/92/93/94/95/96/97/98/99/100> <WINS IP>

```

Syntax Description

Parameter	Description
<2/3/4/5/6/7/8/9/10/11/12/13/14/15/16/17/18/19/20/21/22/23/24/25/26/27/28/29/30/31/32/33/34/35/36/37/38/39/40/41/42/43/44/45/46/47/48/49/50/51/52/53/54/55/56/57/58/59/60/61/62/63/64/65/66/67/68/69/70/71/72/73/74/75/76/77/78/79/80/81/82/83/84/85/86/87/88/89/90/91/92/93/94/95/96/97/98/99/100>	It means LAN interface.
2	2=LAN2
3	3=LAN3
4	4=LAN4
5	5=LAN5
6	6=LAN6
....

6/77/78/79/80/81/82/83/84/85/86/87/88/89/90/91/92/93/94/95/96/97/98/99/100>	100=LAN100
<WINS IP>	Enter the IP address as the WINS IP.

Example

```

> msubnet primWINS ?
% msubnet primWINS
<2/3/4/5/6/7/8/9/10/11/12/13/14/15/16/17/18/19/20/21/22/23/24/25/26
/27/28/29/30/31/32/33/34/35/36/37/38/39/40/41/42/43/44/45/46/47/48/
49/50/51/52/53/54/55/56/57/58/59/60/61/62/63/64/65/66/67/68/69/70/7
1/72/73/74/75/76/77/78/79/80/81/82/83/84/85/86/87/88/89/90/91/92/93
/94/95/96/97/98/99/100> <WINS IP>
% Now:
78/79/80/81/82/83/84/85/86/87/88/89/90/91/92/93/94/95/96/97/98/99/1
00 0.0.0.0;
82/83/84/85/86/87/88/89/90/91/92/93/94/95/96/97/98/99/100 0.0.0.0;
86/87/88/89/90/91/92/93/94/95/96/97/98/99/100 0.0.0.0;
90/91/92/93/94/95/96/97/98/99/100
0 0.0.0.0; 94/95/96/97/98/99/100 0.0.0.0; 98/99/100 0.0.0.0; 0.0.0.0;
0.0.0.0; 0.0.0.0; 0.0.0.0; 0.0.0.0; 0.0.0.0; 0.0.0.0; 0.0.0.0;
0.0.0.0; 0.0.0.0; 0.0.0.0; 0.0.0.0; 0.0.0.0; 0.0.0.0; 0.0.0.0;
0.0.0.0; 0.0.0.0; 0.0.0.0; 0.0.0.0; 0.0.0.0; 0.0.0.0; 0.0.0.0;
0.0.0.0; 0.0.0.0; 0.0.0.0; 0.0.0.0; 0.0.0.0; 0.0.0.0; 0.0.0.0;
0.0.0.0; 0.0.0.0; 0.0.0.0; 0.0.0.0; 0.0.0.0; 0.0.0.0; 0.0.0.0;
0.0.0.0; 0.0.0.0; 0.0.0.0; 0.0.0.0; 0.0.0.0; 0.0.0.0; 0.0.0.0;
0.0.0.0; 0.0.0.0; 0.0.0.0; 0.0.0.0; 0.0.0.0; 0.0.0.0; 0.0.0.0;
0.0.0.0
> msubnet primWINS 2 192.168.3.5
% Set
78/79/80/81/82/83/84/85/86/87/88/89/90/91/92/93/94/95/96/97/98/99/1
00 Dhcp
Primary WINS IP done !!!

> msubnet primWINS ?
% msubnet primWINS
<2/3/4/5/6/7/8/9/10/11/12/13/14/15/16/17/18/19/20/21/22/23/24/25/26
/27/28/29/30/31/32/33/34/35/36/37/38/39/40/41/42/43/44/45/46/47/48/
49/50/51/52/53/54/55/56/57/58/59/60/61/62/63/64/65/66/67/68/69/70/7
1/72/73/74/75/76/77/78/79/80/81/82/83/84/85/86/87/88/89/90/91/92/93
/94/95/96/97/98/99/100> <WINS IP>
% Now:
78/79/80/81/82/83/84/85/86/87/88/89/90/91/92/93/94/95/96/97/98/99/1
00 192.168.3.5;
82/83/84/85/86/87/88/89/90/91/92/93/94/95/96/97/98/99/100 0.0.0.0;
86/87/88/89/90/91/92/93/94/95/96/97/98/99/100 0.0.0.0;
90/91/92/93/94/95/96/97/98/99/100 0.0.0.0; 94/95/96/97/98/99/100
0.0.0.0; 98/99/100 0.0.0.0; 0.0.0.0; 0.0.0.0; 0.0.0.0; 0.0.0.0;
0.0.0.0; 0.0.0.0; 0.0.0.0; 0.0.0.0; 0.0.0.0; 0.0.0.0; 0.0.0.0;
0.0.0.0; 0.0.0.0; 0.0.0.0; 0.0.0.0; 0.0.0.0; 0.0.0.0; 0.0.0.0;
0.0.0.0; 0.0.0.0; 0.0.0.0; 0.0.0.0; 0.0.0.0; 0.0.0.0; 0.0.0.0;
0.0.0.0

```

0.0.0.0;	0.0.0.0;	0.0.0.0;	0.0.0.0;	0.0.0.0;	0.0.0.0;	0.0.0.0;
0.0.0.0;	0.0.0.0;	0.0.0.0;	0.0.0.0;	0.0.0.0;	0.0.0.0;	0.0.0.0;
0.0.0.0;	0.0.0.0;	0.0.0.0;	0.0.0.0;	0.0.0.0;	0.0.0.0;	0.0.0.0;
0.0.0.0;	0.0.0.0;	0.0.0.0;	0.0.0.0;	0.0.0.0;	0.0.0.0;	0.0.0.0;
0.0.0.0;	0.0.0.0;	0.0.0.0;	0.0.0.0;	0.0.0.0;	0.0.0.0;	0.0.0.0;
0.0.0.0;	0.0.0.0;	0.0.0.0;	0.0.0.0;	0.0.0.0;	0.0.0.0;	0.0.0.0;
0.0.0.0;	0.0.0.0;	0.0.0.0;	0.0.0.0;	0.0.0.0;	0.0.0.0;	0.0.0.0;
0.0.0.0;	0.0.0.0;	0.0.0.0;	0.0.0.0;	0.0.0.0;	0.0.0.0;	0.0.0.0;
0.0.0.0;	0.0.0.0;	0.0.0.0;	0.0.0.0;	0.0.0.0;	0.0.0.0;	0.0.0.0;
0.0.0.0;	0.0.0.0;	0.0.0.0;	0.0.0.0;	0.0.0.0;	0.0.0.0;	0.0.0.0;
0.0.0.0;	0.0.0.0;	0.0.0.0;	0.0.0.0;	0.0.0.0;	0.0.0.0;	0.0.0.0;
0.0.0.0;	0.0.0.0;	0.0.0.0;	0.0.0.0;	0.0.0.0;	0.0.0.0;	0.0.0.0;

Telnet Command: msubnet secWINS

This command is used to configure secondary WINS server.

Syntax

```
msubnet secWINS % msubnet secWINS
<2/3/4/5/6/7/8/9/10/11/12/13/14/15/16/17/18/19/20/21/22/23/24/25/26/27/28/29/30/31/32/33/34/35/36/37/38/39/40/41/42/43/44/45/46/47/48/49/50/51/52/53/54/55/56/57/58/59/60/61/62/63/64/65/66/67/68/69/70/71/72/73/74/75/76/77/78/79/80/81/82/83/84/85/86/87/88/89/90/91/92/93/94/95/96/97/98/99/100> <WINS IP>
```

Syntax Description

Parameter	Description
<2/3/4/5/6/7/8/9/10/11/12/13/14/15/16/17/18/19/20/21/22/23/24/25/26/27/28/29/30/31/32/33/34/35/36/37/38/39/40/41/42/43/44/45/46/47/48/49/50/51/52/53/54/55/56/57/58/59/60/61/62/63/64/65/66/67/68/69/70/71/72/73/74/75/76/77/78/79/80/81/82/83/84/85/86/87/88/89/90/91/92/93/94/95/96/97/98/99/100>	It means LAN interface. 2=LAN2 3=LAN3 4=LAN4 5=LAN5 6=LAN6 100=LAN100
<WINS IP>	Type the IP address as the WINS IP.

Example

```
> msubnet secWINS 2 192.168.3.89
% Set
78/79/80/81/82/83/84/85/86/87/88/89/90/91/92/93/94/95/96/97/98/99/100 Dhcp
Secondary WINS IP done !!!
> msubnet secWINS ?
% msubnet secWINS
<2/3/4/5/6/7/8/9/10/11/12/13/14/15/16/17/18/19/20/21/22/23/24/25/26/27/28/29/30/31/32/33/34/35/36/37/38/39/40/41/42/43/44/45/46/47/48/49/50/51/52/53/54/55/56/57/58/59/60/61/62/63/64/65/66/67/68/69/70/71/72/73/74/75/76/77/78/79/80/81/82/83/84/85/86/87/88/89/90/91/92/93/94/95/96/97/98/99/100> <WINS IP>
% Now:
78/79/80/81/82/83/84/85/86/87/88/89/90/91/92/93/94/95/96/97/98/99/100 192.168.3.89;
```

```
82/83/84/85/86/87/88/89/90/91/92/93/94/95/96/97/98/99/100 0.0.0.0;
86/87/88/89/90/91/92/93/94/95/96/97/98/99/100 0.0.0.0;
90/91/92/93/94/95/96/97/98/
99/100 0.0.0.0; 94/95/96/97/98/99/100 0.0.0.0; 98/99/100 0.0.0.0;
0.0.0.0; 0.0.0.0; 0.0.0.0; 0.0.0.0; 0.0.0.0; 0.0.0.0; 0.0.0.0;
0.0.0.0; 0.0.0.0; 0.0.0.0; 0.0.0.0; 0.0.0.0; 0.0.0.0; 0.0.0.0;
0.0.0.0; 0.0.0.0; 0.0.0.0; 0.0.0.0; 0.0.0.0; 0.0.0.0; 0.0.0.0;
0.0.0.0; 0.0.0.0; 0.0.0.0; 0.0.0.0; 0.0.0.0; 0.0.0.0; 0.0.0.0;
0.0.0.0; 0.0.0.0; 0.0.0.0; 0.0.0.0; 0.0.0.0; 0.0.0.0; 0.0.0.0;
0.0.0.0; 0.0.0.0; 0.0.0.0; 0.0.0.0; 0.0.0.0; 0.0.0.0; 0.0.0.0;
0.0.0.0; 0.0.0.0; 0.0.0.0; 0.0.0.0; 0.0.0.0; 0.0.0.0; 0.0.0.0;
0.0.0.0; 0.0.0.0; 0.0.0.0; 0.0.0.0; 0.0.0.0; 0.0.0.0; 0.0.0.0;
0.0.0.0; 0.0.0.0; 0.0.0.0; 0.0.0.0; 0.0.0.0; 0.0.0.0; 0.0.0.0;
0.0.0.0; 0.0.0.0; 0.0.0.0; 0.0.0.0; 0.0.0.0; 0.0.0.0; 0.0.0.0;
0.0.0.0; 0.0.0.0; 0.0.0.0; 0.0.0.0; 0.0.0.0; 0.0.0.0; 0.0.0.0;
0.0.0.0; 0.0.0.0; 0.0.0.0; 0.0.0.0; 0.0.0.0; 0.0.0.0; 0.0.0.0;
0.0.0.0; 0.0.0.0; 0.0.0.0; 0.0.0.0; 0.0.0.0; 0.0.0.0; 0.0.0.0;
```

Telnet Command: msubnet tftp

This command is used to set TFTP server for multi-subnet.

Syntax

```
msubnet tftp
<2/3/4/5/6/7/8/9/10/11/12/13/14/15/16/17/18/19/20/21/22/23/24/25/26/27/28/29/30
/31/32/33/34/35/36/37/38/39/40/41/42/43/44/45/46/47/48/49/50/51/52/53/54/55/56/
57/58/59/60/61/62/63/64/65/66/67/68/69/70/71/72/73/74/75/76/77/78/79/80/81/82/8
3/84/85/86/87/88/89/90/91/92/93/94/95/96/97/98/99/100> <TFTP servername>
```

Syntax Description

Parameter	Description
<2/3/4/5/6/7/8/9/10/11/12/13/14/15/16/17/18/19/20/21/22/23/24/25/26/27/28/29/30/31/32/33/34/35/36/37/38/39/40/41/42/43/44/45/46/47/48/49/50/51/52/53/54/55/56/57/58/59/60/61/62/63/64/65/66/67/68/69/70/71/72/73/74/75/76/77/78/79/80/81/82/83/84/85/86/87/88/89/90/91/92/93/94/95/96/97/98/99/100>	It means LAN interface. 2=LAN2 3=LAN3 4=LAN4 5=LAN5 6=LAN6 100=LAN100
<TFTP servername>	Type a name to indicate the TFTP server.

Example

```
> msubnet tftp 2 publish
% Set
78/79/80/81/82/83/84/85/86/87/88/89/90/91/92/93/94/95/96/97/98/99/100
TFTP Server Name done !!!

> msubnet tftp ?
```

```

% msubnet tftp
<2/3/4/5/6/7/8/9/10/11/12/13/14/15/16/17/18/19/20/21/22/23/24/25/26
/27/28/29/30/31/32/33/34/35/36/37/38/39/40/41/42/43/44/45/46/47/48/
49/50/51/52/53/54/55/56/57/58/59/60/61/62/63/64/65/66/67/68/69/70/7
1/72/73/74/75/76/77/78/79/80/81/82/83/84/85/86/87/88/89/90/91/92/93
/94/95/96/97/98/99/100> <TFTP server name>

% Now:
78/79/80/81/82/83/84/85/86/87/88/89/90/91/92/93/94/95/96/97/98/99/1
00 publish
    82/83/84/85/86/87/88/89/90/91/92/93/94/95/96/97/98/99/100
    86/87/88/89/90/91/92/93/94/95/96/97/98/99/100
    90/91/92/93/94/95/96/97/98/99/100
    94/95/96/97/98/99/100
    98/99/100

```

Telnet Command: msubnet mtu

This command allows you to configure MTU value for LAN/DMZ/IP Routed Subnet.

Syntax

`msubnet mtu <interface> <value>`

Syntax Description

Parameter	Description
<i>interface</i>	Available settings include LAN1~LAN100, IP_Routed_Subnet.
<i>value</i>	1000 ~ 1508 (Bytes), default: 1500 (Bytes)

Example

```

> msubnet mtu LAN1 1492
> msubnet mtu ?
Usage:

>msubnet mtu <interface> <value>

<interface>: LAN1~LAN6,IP_Routed_Subnet,DMZ
<value>:     1000 ~ 1508 (Bytes), default: 1500 (Bytes)

e.x: >msubnet mtu LAN1 1492

Current Settings:

LAN1 MTU:           1492 (Bytes)
LAN2 MTU:           1500 (Bytes)
LAN3 MTU:           1500 (Bytes)
LAN4 MTU:           1500 (Bytes)

```

```

LAN5 MTU:          1500 (Bytes)
LAN6 MTU:          1500 (Bytes)
LAN7 MTU:          1500 (Bytes)
LAN8 MTU:          1500 (Bytes)
LAN9 MTU:          1500 (Bytes)
...
LAN99 MTU:         1500 (Bytes)
LAN100 MTU:        1500 (Bytes)
IP Routed Subnet MTU: 1500 (Bytes)
>

```

Telnet Command: msubnet leasetime

This command allows you to set leasetime for DHCP server. It is helpful to manage the IP address(es) assigned by DHCP server.

Syntax

`msubnet leasetime <1/2/3/.../100> <Lease Time (sec.)>`

Syntax Description

Parameter	Description
<i>1~100</i>	1 - 100 represent LAN1 to LAN100.
<i>Lease Time (sec.)</i>	Range from 1 to 259200. If no value specified here, Vigor router system will use the maximum value, 259200, as the leasetime.

Example

```

> msubnet leasetime ?
% Now: LAN1 86400
      LAN2 259200
      LAN3 259200
      LAN4 259200
      LAN5 259200
      LAN6 259200
      LAN7 259200
      LAN8 259200
      LAN9 259200
      LAN10 259200
      LAN11 259200
      LAN12 259200
      LAN13 259200
      LAN14 259200
      LAN15 259200
      LAN16 259200
      LAN17 259200
      LAN18 259200
      LAN19 259200
      LAN20 259200
      LAN21 259200

      LAN22 259200

```

```

--- MORE ---  ['q': Quit, 'Enter': New Lines, 'Space Bar': Next Page] ---
> msubnet leasetime 1
% Set LAN1 lease time: 259200

```

Telnet Command: object ip obj

This command is used to create an IP object profile.

Syntax

object ip obj setdefault

object ip obj *INDEX* -v

object ip obj *INDEX* -n *NAME*

object ip obj *INDEX* -i *INTERFACE*

object ip obj *INDEX* -s *INVERT*

object ip obj *INDEX* -a *TYPE* <*START_IP*><*END/MASK_IP*>

Syntax Description

Parameter	Description
<i>setdefault</i>	It means to return to default settings for all profiles.
<i>INDEX</i>	It means the index number of the specified object profile.
-v	It means to view the information of the specified object profile. Example: <i>object ip obj 1 -v</i>
-n <i>NAME</i>	It means to define a name for the IP object. NAME: Type a name with less than 15 characters. Example: <i>object ip obj 9 -n bruce</i>
-i <i>INTERFACE</i>	It means to define an interface for the IP object. INTERFACE=0, means any INTERFACE=1, means LAN INTERFACE=3, means WAN Example: <i>object ip obj 8 -i 0</i>
-s <i>INVERT</i>	It means to set invert selection for the object profile. INVERT=0, means disabling the function. INVERT=1, means enabling the function. Example: <i>object ip obj 3 -s 1</i>
-a <i>TYPE</i>	It means to set the address type and IP for the IP object profile. TYPE=0, means Mask TYPE=1, means Single TYPE=2, means Any TYPE=3, means Range TYPE=4, means MAC Example: <i>object ip obj 3 -a 2</i>
< <i>START_IP</i> >	When the TYPE is set with 2, you have to type an IP address as a starting point and another IP address as end point. Type an IP address.
< <i>END/MASK_IP</i> >	Type an IP address (different with <i>START_IP</i>) as the end IP address.

Example

```

> object ip obj 1 -n marketing
OK.
> object ip obj 1 -a 1 192.168.1.45
OK.
> object ip obj 1 -v
IP Object Profile 1
Name      :[marketing]
Interface:[Any]
Address type:[single]
Start ip address:[192.168.1.45]
End/Mask ip address:[0.0.0.0]
MAC Address:[00:00:00:00:00:00]
Invert Selection:[0]

```

Telnet Command: object ip grp

This command is used to integrate several IP objects under an IP group profile.

Syntax

```

object ip grp setdefault
object ip grp INDEX -v
object ip grp INDEX -n NAME
object ip grp INDEX -i INTERFACE
object ip grp INDEX -a IP_OBJ_INDEX

```

Syntax Description

Parameter	Description
<i>setdefault</i>	It means to return to default settings for all profiles.
<i>INDEX</i>	It means the index number of the specified group profile.
<i>-v</i>	It means to view the information of the specified group profile. Example: <i>object ip grp 1 -v</i>
<i>-n NAME</i>	It means to define a name for the IP group. NAME: Type a name with less than 15 characters. Example: <i>object ip grp 8 -n bruce</i>
<i>-i INTERFACE</i>	It means to define an interface for the IP group. INTERFACE=0, means any INTERFACE=1, means LAN INTERFACE=2, means WAN Example: <i>object ip grp 3 -i 0</i>
<i>-a IP_OBJ_INDEX</i>	It means to specify IP object profiles for the group profile. Example: <i>:object ip grp 3 -a "1 2 3 4 5"</i> The IP object profiles with index number 1,2,3,4 and 5 will be grouped under such profile.

Example

```

> object ip grp 2 -n First
IP Group Profile 2
Name      :[First]

```



```

Interface:[Any]
Included ip object index:
[0:][0]
[1:][0]
[2:][0]
[3:][0]
...
[99:][0]

Set ok!
> Set ok!

```

Telnet Command: object ipv6 obj

This command is used to create an IP object profile.

Syntax

`object ipv6 obj setdefault`

`object ipv6 obj INDEX -v`

`object ipv6 obj INDEX -n NAME`

`object ipv6 obj INDEX -s INVERT`

`object ipv6 obj INDEX -e MATCH_TYPE`

`object ipv6 obj INDEX -a TYPE <START_IP><END_IP><Prefix Length>`

Syntax Description

Parameter	Description
<i>setdefault</i>	It means to return to default settings for all profiles.
<i>INDEX</i>	It means the index number of the specified object profile.
<i>-v</i>	It means to view the information of the specified object profile. Example: <code>object ipv6 obj 1 -v</code>
<i>-n NAME</i>	It means to define a name for the IP object. NAME: Type a name with less than 15 characters. Example: <code>object ipv6 obj 9 -n bruce</code>
<i>-e MATCH_TYPE</i>	It means to set the match type of ipv6 object profile. MATCH_TYPE=0, means 128 bits MATCH_TYPE=1, means suffix 64 bits interface ID Example: <code>object ipv6 obj 8 -i 0</code>
<i>-s INVERT</i>	It means to set invert selection for the object profile. INVERT=0, means disabling the function. INVERT=1, means enabling the function. Example: <code>object ipv6 obj 3 -e 1</code>
<i>-a TYPE</i>	It means to set the address type and IP for the IP object profile. TYPE=0, means Mask TYPE=1, means Single

	TYPE=2, means Any TYPE=3, means Range TYPE=4, means MAC Example: <i>object ipv6 obj 3 -a 2</i>
<START_IP><END_IP><Prefix Length>	When the TYPE is set with 0, 1,3, you have to type an IP address as a starting point and another IP address as end point. <START_IP><END_IP>: Type an IPv6 address as the start IPv6 address and another IPv6 address (different with START_IP) as the end IPv6 address. <Prefix Length>: Specify the prefix length.

Example

```

> obj ipv6 obj 3 -a 3 2607:f0d0:1002:51::4 2607:f0d0:1002:51::4
Setting saved.

> obj ipv6 obj 3 -v
IPv6 Object Profile 3
Name      :[]
Address Type:[range]
Start IPv6 Address:[2607:F0D0:1002:51::4]
End IPv6 Address:[2607:F0D0:1002:51::4]
Prefix Length:[0]
MAC Address:[00:00:00:00:00:00]
Invert Selection:[0]
Match Type:[0]

```

Telnet Command: object ipv6 grp

This command is used to integrate several IPv6 objects under an IPv6 group profile.

Syntax

- object ipv6 grp setdefault
- object ipv6 grp *INDEX* -v
- object ipv6 grp *INDEX* -n *NAME*
- object ipv6 grp *INDEX* -a *IP_OBJ_INDEX*

Syntax Description

Parameter	Description
<i>setdefault</i>	It means to return to default settings for all profiles.
<i>INDEX</i>	It means the index number of the specified group profile.
-v	It means to view the information of the specified group profile. Example: <i>object ipv6 grp 1 -v</i>
-n <i>NAME</i>	It means to define a name for the IP group. NAME: Type a name with less than 15 characters. Example: <i>object ipv6 grp 8 -n bruce</i>
-a <i>IP_OBJ_INDEX</i>	It means to specify IP object profiles for the group profile. Example: <i>:object ipv6 grp 3 -a 1 2 3 4 5</i> The IP object profiles with index number 1,2,3,4 and 5 will be group under such profile.

Example

```
> object ipv6 grp 1 -n marketingtest
IPv6 Group Profile 1
Name   :[marketingtest]
Included ip object index:
[0:][0]
[1:][0]
[2:][0]
...
[99:][0]
>
```

Telnet Command: object country

This command is used to create country object profile.

Syntax

```
object country set INDEX -v
object country set INDEX -n NAME
object country set INDEX -a COUNTRY_INDEX
object country activate
object country setdefault
object country list
```

Syntax Description

Parameter	Description
<i>INDEX</i>	It means the index number of the specified country object profile (1 to 32).
<i>COUNTRY_INDEX</i>	It means the code number of a country. To get the detailed information of the code number, use "object country list" to get the one you need.
<i>activate</i>	It means to activate the country object profile.
<i>setdefault</i>	It means to return to default settings for all profiles.
<i>list</i>	Displays a list of country with code number. For example, "222" means "Taiwan"; "241" means "United States".

Example

```
> object country set 1 -n Best
Country object Profile 1
Name   :[Best]
Included country index:
Set ok!
> object country set 1 -a 222
Country object Profile 1
Name   :[Best]
Included country index:
[0:][222] Taiwan
```

```
Set ok!
>
```

Telnet Command: object service obj

This command is used to create service object profile.

Syntax

object service obj setdefault

object service obj *INDEX* -v

object service obj *INDEX* -n *NAME*

object service obj *INDEX* -p *PROTOCOL*

object service obj *INDEX* -s *CHK* <*START_P*><*END_P*>

object service obj *INDEX* -d *CHK* <*START_P*><*END_P*>

Syntax Description

Parameter	Description
<i>setdefault</i>	It means to return to default settings for all profiles.
<i>INDEX</i>	It means the index number of the specified service object profile.
-v	It means to view the information of the specified service object profile. Example: <i>object service obj 1 -v</i>
-n <i>NAME</i>	It means to define a name for the IP object. NAME: Type a name with less than 15 characters. Example: <i>object service obj 9 -n bruce</i>
-i <i>PROTOCOL</i>	It means to define a PROTOCOL for the service object profile. PROTOCOL =0, means any PROTOCOL =1, means ICMP PROTOCOL =2, means IGMP PROTOCOL =6, means TCP PROTOCOL =17, means UDP PROTOCOL =58, means ICMPv6 PROTOCOL =255, means TCP/UDP Other values mean other protocols. Example: <i>object service obj 8 -i 0</i>
<i>CHK</i>	It means the check action for the port setting. 0=equal(=), when the starting port and ending port values are the same, it indicates one port; when the starting port and ending port values are different, it indicates a range for the port and available for this service type. 1=not equal(!=), when the starting port and ending port values are the same, it indicates all the ports except the port defined here; when the starting port and ending port values are different, it indicates that all the ports except the range defined here are available for this service type. 2=larger(>), the port number greater than this value is available.. 3=less(<), the port number less than this value is available for this profile.
-s <i>CHK</i> < <i>START_P</i> >< <i>END_P</i> >	It means to set source port check and configure port range (1-65535) for TCP/UDP. START_P: Enter a port number to indicate the starting source port.

	END_P: Enter a port number to indicate the ending source port. Example: <i>object service obj 3 -s 0 100 200</i>
-d CHK <START_P><END_P>	It means to set destination port check and configure port range (1-65535) for TCP/UDP. START_P: Enter a port number to indicate the starting destination port. END_P: Enter a port number to indicate the ending destination port. Example: <i>object service obj 3 -d 1 100 200</i>

Example

```
> object service obj 1 -n limit
> object service obj 1 -p 255
> object service obj 1 -s 1 120 240
> object service obj 1 -d 1 200 220
> object service obj 1 -v
Service Object Profile 1
Name      :[limit]
Protocol  :[TCP/UDP]
Source port check action:[!=]
Source port range:[120~240]
Destination port check action:[!=]
Destination port range:[200~220]
>
```

Telnet Command: object service grp

This command is used to integrate several service objects under a service group profile.

Syntax

object service grp setdefault

object service grp INDEX -v

object service grp INDEX -n NAME

object service grp INDEX -a SER_OBJ_INDEX

Syntax Description

Parameter	Description
<i>setdefault</i>	It means to return to default settings for all profiles.
<i>INDEX</i>	It means the index number of the specified group profile.
<i>-v</i>	It means to view the information of the specified group profile. Example: <i>object service grp 1 -v</i>
<i>-n NAME</i>	It means to define a name for the service group. NAME: Type a name with less than 15 characters. Example: <i>object service grp 8 -n bruce</i>
<i>-a SER_OBJ_INDEX</i>	It means to specify service object profiles for the group profile. Example: <i>:object service grp 3 -a 1 2 3 4 5</i> The service object profiles with index number 1,2,3,4 and 5 will be group under such profile.

Example

```

>object service grp 1 -n Grope_1
Service Group Profile 1
Name   :[Grope_1]
Included service object index:
[0:][0]
[1:][0]
[2:][0]
...
[99:][0]

> object service grp 1 -a 1 2
Service Group Profile 1
Name   :[Grope_1]
Included service object index:
[0:][1]
[1:][2]
[2:][0]
...
[99:][0]
>

```

Telnet Command: object kw

This command is used to create keyword profile.

Syntax

```

object kw obj setdefault
object kw obj show PAGE
object kw obj INDEX -v
object kw obj INDEX -n NAME
object kw obj INDEX -a CONTENTS
object kw obj INDEX -c

```

Syntax Description

Parameter	Description
<i>setdefault</i>	It means to return to default settings for all profiles.
<i>show PAGE</i>	It means to show the contents of the specified profile. PAGE: type the page number.
<i>show</i>	It means to show the contents for all of the profiles.
<i>INDEX</i>	It means the index number of the specified keyword profile.
<i>-v</i>	It means to view the information of the specified keyword profile.
<i>-n NAME</i>	It means to define a name for the keyword profile. NAME: Type a name with less than 15 characters.
<i>-a CONTENTS</i>	It means to set the contents for the keyword profile. Example: <i>object kw obj 40 -a test</i>
<i>-c</i>	It means to clear the content of keyword object profile. Example: <i>object kw obj 40 -c</i>

Example

```
> object kw obj 1 -n children
Profile 1
Name   :[children]
Content:[]
> object kw obj 1 -a gambling
Profile 1
Name   :[children]
Content:[gambling]

> object kw obj 1 -v
Profile 1
Name   :[children]
Content:[gambling]
>
```

Telnet Command: object fe

This command is used to create File Extension Object profile.

Syntax

`object fe show`

`object fe setdefault`

`object fe obj INDEX -v`

`object fe obj INDEX -n NAME`

`object fe obj INDEX -e CATEGORY|FILE_EXTENSION`

`object fe obj INDEX -d CATEGORY|FILE_EXTENSION`

Syntax Description

Parameter	Description
<i>show</i>	It means to show the contents for all of the profiles.
<i>setdefault</i>	It means to return to default settings for all profiles.
<i>INDEX</i>	It means the index number (from 1 to 8) of the specified file extension object profile.
<i>-v</i>	It means to view the information of the specified file extension object profile.
<i>-n NAME</i>	It means to define a name for the file extension object profile. NAME: Type a name with less than 15 characters.
<i>-e</i>	It means to enable the specific CATEGORY or FILE_EXTENSION.
<i>-d</i>	It means to disable the specific CATEGORY or FILE_EXTENSION
<i>CATEGORY FILE_EXTENSION</i>	CATEGORY: Image, Video, Audio, Java, ActiveX, Compression, Execution Example: <code>object fe obj 1 -e Image</code> FILE_EXTENSION: ".bmp", ".dib", ".gif", ".jpeg", ".jpg", ".jpg2", ".jp2", ".pct", ".pcx", ".pic", ".pict", ".png", ".tif", ".tiff", ".ico", ".asf", ".avi", ".mov", ".mpe", ".mpeg", ".mpg", ".mp4", ".qt", ".rm", ".wmv", ".3gp", ".3gpp", ".3gpp2", ".3g2", ".flv", ".swf", ".aac", ".aiff", ".au", ".mp3", ".m4a", ".m4p", ".ogg", ".ra", ".ram", ".vox", ".wav", ".wma", ".class", ".jad", ".jar", ".jav", ".java", ".jcm", ".js", ".jse", ".jsp", ".jtk", ".alx",

```
".apb", ".axs", ".ocx", ".olb", ".ole", ".tlb", ".viv", ".vrm", ".ace",
".arj", ".bzip2", ".bz2", ".cab", ".gz", ".gzip", ".rar", ".sit", ".zip",
".bas", ".bat", ".com", ".exe", ".inf", ".pif", ".reg", ".scr", ".torrent",
".doc", ".docx", ".odp", ".ods", ".odt", ".pdf", ".ppt", ".pptx", ".xls",
".xlsx"
```

```
Example: object fe obj 1 -e .bmp
```

Example

```
> object fe obj 1 -n music
> object fe obj 1 -e Audio
> object fe obj 1 -v
Profile Index: 1
Profile Name:[music]

-----
Image category:
[ ].bmp [ ].dib [ ].gif [ ].jpeg [ ].jpg [ ].jpg2 [ ].jp2 [ ].pct
[ ].pcx [ ].pic [ ].pict [ ].png [ ].tif [ ].tiff [ ].ico
-----
Video category:
[ ].asf [ ].avi [ ].mov [ ].mpe [ ].mpeg [ ].mpg [ ].mp4 [ ].qt
[ ].rm [ ].wmv [ ].3gp [ ].3gpp [ ].3gpp2 [ ].3g2 [ ].flv [ ].swf
-----
Audio category:
[v].aac [v].aiff [v].au [v].mp3 [v].m4a [v].m4p [v].ogg [v].ra
[v].ram [v].vox [v].wav [v].wma
-----
Java category:
[ ].class [ ].jad [ ].jar [ ].jav [ ].java [ ].jcm [ ].js [ ].jse
[ ].jsp [ ].jtk
-----
ActiveX category:
[ ].alx [ ].apb [ ].axs [ ].ocx [ ].olb [ ].ole [ ].tlb [ ].viv
[ ].vrm
-----
Compression category:
[ ].ace [ ].arj [ ].bzip2 [ ].bz2 [ ].cab [ ].gz [ ].gzip [ ].rar
[ ].sit [ ].zip
-----
Execution category:
[ ].bas [ ].bat [ ].com [ ].exe [ ].inf [ ].pif [ ].reg [ ].scr
-----
P2P category:
[ ].torrent
-----
Document category:
[ ].doc [ ].docx [ ].odp [ ].ods [ ].odt [ ].pdf [ ].ppt [ ].pptx
[ ].xls [ ].xlsx
>
```

Telnet Command: **object sms**

This command is used to create short message object profile.

Syntax

```
object sms show
```

object sms setdefault
 object sms obj *INDEX* -v
 object sms obj *INDEX* -n *NAME*
 object sms obj *INDEX* -s *Service Provider*
 object sms obj *INDEX* -u *Username*
 object sms obj *INDEX* -p *Password*
 object sms obj *INDEX* -q *Quota*
 object sms obj *INDEX* -i *Interval*
 object sms obj *INDEX* -I *URL*

Syntax Description

Parameter	Description
<i>show</i>	It means to show the contents for all of the profiles.
<i>setdefault</i>	It means to return to default settings for all profiles.
<i>[INDEX]</i>	It means the index number (from 1 to 10) of the specified SMS object profile.
-v	It means to view the information of the specified SMS object profile.
-n <i>[NAME]</i>	It means to define a name for the SMS object profile. NAME: Type a name with less than 15 characters.
-s <i>[Service Provider]</i>	It means to specify the number of the service provider which offers the service of SMS. Different numbers represent different service provider. 0 : kotsms.com.tw (TW) 2 : textmarketer.co.uk (UK) 4 : messagemedia.co.uk (UK) 5 : bulksms.com (INT) 6 : bulksms.co.uk (UK) 7 : bulksms.2way.co.za (ZA) 8 : bulksms.com.es (ES) 9 : usa.bulksms.com (US) 10 : bulksms.de (DE) 11 : www.pswin.com (EU) 12 : www.messagebird.com (EU) 13 : www.lusosms.com (EU) 14 : www.vibeactivemedia.com (UK)
-u <i>[Username]</i>	It means to define a user name for the SMS object profile. Type a user name that the sender can use to register to selected SMS provider.
-p <i>[Password]</i>	It means to define a password for the SMS object profile. Type a password that the sender can use to register to selected SMS provider.
-q <i>[Quota]</i>	Enter the number of the credit that you purchase from the service provider. Note that one credit equals to one SMS text message on the standard route.
-I <i>[Interval]</i>	It means to set the sending interval for the SMS to be delivered. Enter the shortest time interval for the system to send SMS.
-I <i>[URL]</i>	It means to set the URL for Custom 1 and Custom 2 profiles. The profile name for Custom 1 and Custom 2 are defined in default and can not be changed.

Example

```

> object sms obj 1 -n CTC
> object sms obj 1 -s 0
> object sms obj 1 -u carrie
> object sms obj 1 -p 19971125cm
> object sms obj 1 -q 2
> object sms obj 1 -i 50
> object sms obj 1 -v
Profile Index: 1
Profile Name:[CTC]
SMS Provider:[kotsms.com.tw (TW)]
Username:[carrie]
Password:[*****]
Quota:[2]
Sending Interval:[50(seconds)]

```

Telnet Command: object mail

This command is used to create mail object profile.

Syntax

```

object mail show
object mail setdefault
object mail obj INDEX -v
object mail obj INDEX -n <Profile Name>
object mail obj INDEX -s <SMTP Server>
object mail obj INDEX -l <Connection security>
object mail obj INDEX -m <SMTP Port>
object mail obj INDEX -a <Sender Address>
object mail obj INDEX -t <Authentication>
object mail obj INDEX -u <Username>
object mail obj INDEX -p <Password>
object mail obj INDEX -i <Sending Interval>
object mail obj INDEX -w <Interface>
object mail obj INDEX -x <Alias IP Index>

```

Syntax Description

Parameter	Description
<i>show</i>	It means to show the contents for all of the profiles.
<i>setdefault</i>	It means to return to default settings for all profiles.
<i>[INDEX]</i>	It means the index number (from 1 to 10) of the specified mail object profile.
<i>-v</i>	It means to view the information of the specified mail object profile.
<i>-n <Profile Name></i>	It means to define a name for the mail object profile. <i>Profile Name:</i> Type a name with less than 15 characters.
<i>-s <SMTP Server></i>	It means to set the IP address of the mail server.
<i>-l <Connection security></i>	It means to use port 465 for SMTP server for some e-mail server uses https as the transmission method. 0 - disable 1 - enable to use the port number.
<i>-m <SMTP Port></i>	It means to set the port number for SMTP server.
<i>-a <Sender Address></i>	It means to set the e-mail address (e.g., johnwash@abc.com.tw) of the sender.
<i>-t <Authentication></i>	The mail server must be authenticated with the correct username

	and password to have the right of sending message out. 0 - disable 1 - enable to use the port number.
<i>-u <Username></i>	Type a name for authentication. The maximum length of the name you can set is 31 characters.
<i>-p <Password></i>	Type a password for authentication. The maximum length of the password you can set is 31 characters.
<i>-i <Sending Interval></i>	Define the interval for the system to send the SMS out. The unit is second.
<i>-w <Interface></i>	Set the interface of the mail server profile.
<i>-x <Alias IP Index></i>	Set the alias IP of mail server profile (1 to 10).

Example

```

> object mail obj 1 -n buyer
> object mail obj 1 -s 192.168.1.98
> object mail obj 1 -m 25
> object mail obj 1 -t 1
> object mail obj 1 -u john
> object mail obj 1 -p happy123456
> object mail obj 1 -i 25
> object mail obj 1 -v
Profile Index: 1
Interface:[Any]
Alias IP Index:[0]
Profile Name:[]
SMTP Server:[192.168.1.98]
SMTP Port:[25]
Sender Address:[] Connection Security:[Plaintext]

Authentication:[enable]
Username:[john]
Password:[*****]
Sending Interval:[25(seconds)]

```

Telnet Command: object noti

This command is used to create notification object profile.

Syntax

```

object noti show
object noti setdefault
object noti obj INDEX -v
object noti obj INDEX -n Profile Name
object mail obj INDEX -e Category Status
object mail obj INDEX -d Category Status

```

Syntax Description

Parameter	Description
<i>show</i>	It means to show the contents for all of the profiles.
<i>setdefault</i>	It means to return to default settings for all profiles.
<i>[INDEX]</i>	It means the index number (from 1 to 8) of the specified notification object profile.
<i>-v</i>	It means to view the information of the specified notification

	object profile.
<i>-n <Profile Name></i>	It means to define a name for the notification object profile. <i>Profile Name:</i> Type a name with less than 15 characters.
<i>-e</i>	It means to enable the status of specified category.
<i>-d</i>	It means to disable the status of specified category.
<i><Category></i>	Available categories are: 1: WAN; 2: VPN Tunnel; 3: Temperature Alert; 4: WAN Budget; 5: CVM; 6: High Availability; 9 : Security
<i><status></i>	For WAN - 1 : Disconnected; 2 : Reconnected. For VPN Tunnel - 1 : Disconnected; 2 : Reconnected. For Temperature Alert - 1 : Out of Range. For WAN Budget - 1 : Limit Reached. For CVM - 1 : CPE Offline; 2 : Backup Fail; 3 : Restore Fail; 4: FW Update Fail. ; 5 : VPN Profile Setup Fail. For High Availability - 1 : Failover Occurred, Config Sync Fail, Router Unstable For Security - 1 : Web Log-in event occurs. 2 : Telnet Log-in event occurs. 3 : SSH Log-in event occurs. 4 : TR069 Log-in event occurs. 5 : FTP User Log-in event occurs. 6 : Config-Changed event occurs.

Example

```

> object noti obj 1 -n market
> object noti obj 1 -e 1 1
> object noti obj 1 -e 2 1
> object noti obj 1 -e 5 3
> object noti obj 1 -v
Profile Index: 1
Profile Name:[market]
      Category                Status
WAN                [v]Disconnected    [ ]Reconnected
VPN Tunnel         [v]Disconnected    [ ]Reconnected
Temperature Alert  [ ]USB Temperature Out of Range
WAN Budget Alert  [ ]Limit Reached
CVM Alert          [ ]CPE Offline
                  [ ]CPE Config Backup Fail
                  [v]CPE Config Restore Fail
                  [ ]CPE Firmware Fpgrade Fail
                  [ ]CPE VPN Profile Setup Fail
High Availability[ ]Failover Occurred
                  Config Sync Fail
                  Router Unstable
Security           [ ]Web Log-in event occurs
                  [ ]Telnet Log-in event occurs

```

```

[ ]SSH Log-in event occurs
[ ]TR069 Log-in event occurs
[ ]FTP User Log-in event occurs
[ ]Config-Changed event occurs
>

```

Telnet Command: object schedule

This command is used to create schedule object profile.

Syntax

```

object schedule set INDEX option
object schedule view
object schedule setdefault

```

Syntax Description

Parameter	Description
<i>set</i>	It means to set the schedule profile.
< <i>INDEX</i> >	It means the index number (from 1 to 15) of the specified object profile.
<i>option</i>	Available options for schedule includes: -e
-e < <i>value</i> >	It means to enable the schedule setup. 0 - disable 1 - enable
-c < <i>comment</i> >	It means to set brief description for the specified profile. The length range of the comment: 1 ~ 32 characters.
-D < <i>year</i> >< <i>month</i> >< <i>day</i> >	It means to set the starting date of the profile. [year] - Must be between 2000-2049. [month] - Must be between 1-12. [day] - Must be between 1-31. For example: To set Start Date 2015/10/6, type > <i>object schedule set 1 -D "2015 10 6"</i>
-T < <i>hour</i> >< <i>minute</i> >	It means to set the starting time of the profile. [hour] - Must be between 0-23. [minute] - Must be between 0-59. For example: To set Start Time 10:20, type > <i>object schedule set 1 -T "10 20"</i>
-d < <i>hour</i> >< <i>minute</i> >	It means to set the duration time of the profile. [hour] - Must be between 0-23. [minute] - Must be between 0-59. For example: To set Duration Time 3:30, type > <i>object schedule set 1 -d "3 30"</i>
-a < <i>value</i> >	It means to set the action used for the profile. [value] - 0:Force On, 1:Force Down, 2:Enable Dial-On-Demand, 3:Disable Dial-On-Demand
-I < <i>value</i> >	It means to set idle time. [value] - Must be between 0-255(minute). The default is 0.
-h < <i>option</i> >< <i>day</i> >	Set how often the schedule will be applied. [option] -

	0: Once, 1: Weekdays [day] - Sun, Mon, Tue, Wed, Thu, Fri, Sat If the [option] set Weekdays, then must select which days of Week. example: To select Sunday, Monday, Thursday, type > <i>object schedule set 1 -h "1 Sun Mon Thu"</i>
<i>view <INDEX></i>	It means to show the content of the profile.
<i>setdefault</i>	It means to return to default settings for all profiles.

Example

```

> object schedule set 1 -e 1
> object schedule set 1 -c Working
> object schedule set 1 -D "2016 11 8"
> object schedule set 1 -T "8 1"
> object schedule set 1 -d "2 30"
> object schedule set 1 -a 0
> object schedule set 1 -h "1 Mon Wed"
> object schedule view 1
Index No.1

-----
[v] Enable Schedule Setup
    Comment [ Working ]
    Start Date (yyyy-mm-dd) [ 2023 ]-[ 11 ]-[ 23 ]
    Start Time (hh:mm)      [ 8 ]:[ 1 ]
    Duration Time (hh:mm)   [ 2 ]:[ 30 ]
    Action                   [ Force On ]
    Idle Timeout            [ 0 ] minute(s).(max. 255, 0 for default)

-----

    How Often
    [v] Weekdays
        [ ]Sun [v]Mon [ ]Tue [v]Wed [ ]Thu [ ]Fri [ ]Sat
>

```

Telnet Command: port

This command allows users to set the speed for specific port of the router.

Syntax

port <1, 2, 3, 4, 5, 6, 7, 8, 9, 10, 11, 12, all> <AN, 100F, 100H, 10F, 10H, status >

port <wan1, wan2, wan3, wan4> <AN, 1000F, 100F, 100H, 10F, 10H, status >

port status

port sniff <on, off, port, txrx, restart, status>

port 802.1x <enable, disable, status, addport, delport>

Syntax Description

Parameter	Description
<1, 2, 3, 4, 5, 6, 7, 8, 9, 10, 11, 12, all><AN, 100F, 100H,	It means the to set the physical type for a LAN port. <1, 2, 3, 4, 5, 6, 7, 8, 9, 10, 11, 12, all> - It means the number of

<i>10F, 10H, status></i>	LAN port. <AN, 100F, 100H, 10F, 10H> - It means the physical type for the specific port. AN: auto-negotiate. 100F: 100M Full Duplex. 100H: 100M Half Duplex. 10F: 10M Full Duplex. 10H: 10M Half Duplex. status: View the Ethernet port status.
<i><wan1, wan2, wan3, wan4> <AN, 1000F, 100F, 100H, 10F, 10H, status></i>	It means the to set the physical type for a LAN port. <wan1, wan2, wan3, wan4> - It means the number of WAN port. <AN, 1000F, 100F, 100H, 10F, 10H, status> - It means the physical type for the specific port. AN: auto-negotiate. 1000F: 1000M Full Duplex. 100F: 100M Full Duplex. 100H: 100M Half Duplex. 10F: 10M Full Duplex. 10H: 10M Half Duplex. status: View the Ethernet port status.
<i>status</i>	It means to view the Ethernet port status.
<i>sniff <on, off, port, txrx, restart, status></i>	It means to set settings for sniffer. <on, off, port, txrx, restart, status>: See the following, on - Turn on the sniffer. off - Turn off the sniffer. port - Specify a LAN port (p1, p2, p3 or p4). restart - Restart the system to activate the settings. status - Display current settings. rxrx - Set the transmission and receiving rates for a LAN/WAN port. e.g., > port sniff txrx 30000 p2
<i>802.1x <enable, disable, status, addport, delport></i>	It means to set settings for 802.1x. <enable, disable, status, addport, delport>: See the following, enable - Enable the function. disable - Disable the function. status - Display current settings. addport - Add a port number (1 to 5). delport - Delete a port number (1 to 5).

Example

```
> port 1 100F
%Set Port 1 Force speed 100 Full duplex OK !!!
```

Telnet Command: portmaptime

This command allows you to set a time of keeping the session connection for specified protocol.

Syntax

```
portmaptime [-<command> <parameter> | ... ]
```

Syntax Description

Parameter	Description
[<command> <parameter> ...]	The available commands with parameters are listed below. [...] means that you can type in several commands in one line.
-t <sec>	It means "TCP" protocol. <sec>: Type a number to set the TCP session timeout.
-u <sec>	It means "UDP" protocol. <sec>: Type a number to set the UDP session timeout.
-i <sec>	It means "IGMP" protocol. <sec>: Type a number to set the IGMP session timeout.
-w <sec>	It means "TCP WWW" protocol. <sec>: Type a number to set the TCP WWW session timeout.
-s <sec>	It means "TCP SYN" protocol. <sec>: Type a number to set the TCP SYN session timeout.
-f	It means to flush all portmaps (useful for diagnostics).
-l <List>	List all settings.

Example

```
> portmuptime -t 86400 -u 300 -i 10
> portmuptime -l
----- Current setting -----
TCP Timeout      : 86400 sec.
UDP Timeout      : 300 sec.
IGMP Timeout     : 10 sec.
TCP WWW Timeout  : 120 sec.
TCP SYN Timeout  : 60 sec.
```

Telnet Command: qos setup

This command allows user to set general settings for QoS.

Syntax

qos setup [-<command> <parameter> | ...]

Syntax Description

Parameter	Description
[<command> <parameter> ...]	The available commands with parameters are listed below. [...] means that you can type in several commands in one line.
-h	Type it to display the usage of this command.
-W <1-12>	It means to specify WAN interface. The default is WAN1. 1: WAN1; 2:WAN2;....
-m <mode>	It means to define which traffic the QoS control settings will apply to and enable QoS control. 0: disable. 1: in, apply to incoming traffic only. 2: out, apply to outgoing traffic only. 3: both, apply to both incoming and outgoing traffic. Default is enable (for outgoing traffic).

<code>-i <bandwidth></code>	It means to set inbound bandwidth in kbps (Ethernet WAN only). The available setting is from 1 to 100000.
<code>-o <bandwidth></code>	It means to set outbound bandwidth in kbps (Ethernet WAN only). The available setting is from 1 to 100000.
<code>-r <index:ratio></code>	It means to set ratio for class index, in %.
<code>-u <mode></code>	It means to enable bandwidth control for UDP. 0: disable 1: enable Default is disable.
<code>-p <ratio></code>	It means to enable bandwidth limit ratio for UDP.
<code>-t <mode></code>	It means to enable/disable Outbound TCP ACK Prioritize. 0: disable 1: enable
<code>-V</code>	Show all the settings.
<code>-I <bandwidth></code>	It means the minimum available non-VoIP Inbound Bandwidth when VoIP is detected (Kbps). <bandwidth>: Enter a value. Default value: half of WAN inbound bandwidth.
<code>-O <bandwidth></code>	It means the minimum available non-VoIP Outbound Bandwidth when VoIP is detected (Kbps). <bandwidth>: Enter a value. Default value: half of WAN outbound bandwidth.
<code>-v <0/1></code>	It means to adjust to minimum In/Out bandwidth setting (or half QoS bandwidth). 0: Auto bandwidth adjustment. 1: When VoIP detected, QoS In/Out bandwidth will be adjusted to minimum values.
<code>-D</code>	Set all to factory default (for all WANs).

Example

```
> qos setup -m 3 -i 9500 -o 8500 -r 3:20 -u 1 -p 50 -t 1

WAN1 QOS mode is both
inbound bandwidth set to 9500
outbound bandwidth set to 8500
WAN1 class 3 ratio set to 20
WAN1 udp bandwidth control set to enable
WAN1 udp bandwidth limit ratio set to 50
WAN1 Outbound TCP ACK Prioritizel set to enable
QoS WAN1 set complete; restart QoS
>
```

Telnet Command: qos class

This command allows user to set QoS class.

Syntax

```
qos class -c <no> -<a/e/d <no>>[-<command> <parameter> | ... ]
```

Syntax Description

Parameter	Description
-----------	-------------

<i>[<command> <parameter>[...]]</i>	The available commands with parameters are listed below. [...] means that you can type in several commands in one line.
<i>-h</i>	Type it to display the usage of this command.
<i>-c <no></i>	Specify the index number for the class. Available value for <no> contains 1, 2 and 3. The default setting is class 1.
<i>-n <name></i>	It means to type a name for the class.
<i>-a</i>	It means to add rule for specified class.
<i>-e <no></i>	It means to edit specified rule. <no>: type the index number for the rule.
<i>-d <no></i>	It means to delete specified rule. <no>: type the index number for the rule.
<i>-m <mode></i>	It means to enable or disable the specified rule. 0: disable, 1: enable
<i>-v <1/0></i>	It means to set the type of IP address version. 1 - IPv6 0 - IPv4
<i>-L < obj_idx1,obj_idx2,grp_idx1, grp_idx2></i>	It means to set the local address type as "IP Group and Objects" (format: obj_idx1,obj_idx2,grp_idx1,grp_idx2). Two IP groups and two IP objects can be set at one time, at most. obj_idx1 - Enter the index number (0 to 192) of IP object. obj_idx2 - Enter the index number (0 to 192) of IP object. grp_idx1 - Enter the index number of IP group. grp_idx2 - Enter the index number of IP group.
<i>-M < obj_idx1,obj_idx2,grp_idx1, grp_idx2></i>	It means to set the remote address type as "IP Group and Objects" (format: obj_idx1,obj_idx2,grp_idx1,grp_idx2). Two IP groups and two IP objects can be set at one time, at most. obj_idx1 - Enter the index number (0 to 192) of IP object. obj_idx2 - Enter the index number (0 to 192) of IP object. grp_idx1 - Enter the index number of IP group. grp_idx2 - Enter the index number of IP group.
<i>-l <addr></i>	Set the local address. <i>addr1</i> - It means Single address. Please specify the IP address directly, for example, " <i>-l 172.16.3.9</i> ". <i>addr1:addr2</i> - It means Range address. Please specify the IP addresses, for example, " <i>-l 172.16.3.9: 172.16.3.50</i> ". <i>addr1:subnet</i> - It means the subnet address with start IP address. Please type the subnet and the IP address, for example, " <i>-l 172.16.3.9:255.255.0.0".0</i> ". <i>any</i> - It means Any address. Simple type " <i>-l</i> " to specify any address for this command.
<i>-r <addr></i>	Set the remote address. <i>addr1</i> - It means Single address. Please specify the IP address directly, for example, " <i>-r 172.16.3.9</i> ". <i>addr1:addr2</i> - It means Range address. Please specify the IP addresses, for example, " <i>-r 172.16.3.9: 172.16.3.50</i> ". <i>addr1:subnet</i> - It means the subnet address with start IP address. Please type the subnet and the IP address, for example, " <i>-r 172.16.3.9:255.255.0.0".0</i> ". <i>any</i> - It means Any address. Simple type " <i>-r</i> " to specify any address for this command.

<code>-l/-r</code>	Set the Address Type to "any". No need to input any IP address.
<code>-p <DSCP id></code>	Specify the ID for a rule. DSCP id - Range from 1 to 20, and ALL_AF (means to choose ALL AF Classes (case insensitive)).
<code>-s <Service type></code>	Specify the predefined service type by typing the number. The available types are listed as below: 1:ANY 2:DNS 3:FTP 4:GRE 5:H.323 6:HTTP 7:HTTPS 8:IKE 9:IPSEC-AH 10:IPSEC-ESP 11:IRC 12:L2TP 13:NEWS 14:NFS 15:NNTP 16:PING 17:POP3 18:PPTP 19:REAL-AUDIO 20:RTSP 21:SFTP 22:SIP 23:SMTP 24:SNMP 25:SNMP-TRAPS 26:SQL-NET 27:SSH 28:SYSLOG 29:TELNET 30:TFTP
<code>-u <Service type></code>	Specify the user defined service type by typing the number (1 to 40).
<code>-o <Service type></code>	Specify the service type object. Up to two sets can be set. Service type - Enter the index number (0 to 96; 0 means not set) of the service type object.
<code>-g <Service type></code>	Specify the service type group. Up to two sets can be set. Service type - Enter the index number (0 to 32; 0 means not set) of the service type group. For example > <code>qos class -c 2 -e 1 -g 1</code>
<code>-S <d/s></code>	Show the content for specified DSCP ID (0 to 20) /Service type. In which, the DSCP ID means; 0: default, 1: IP precedence 1, 2: IP precedence 2, 3: IP precedence 3, 4: IP precedence 4, 5: IP precedence 5, 6: IP precedence 6, 7: IP precedence 7, 8: AF Class1 (Low Drop), 9: AF Class1 (Medium Drop), 10: AF Class1 (High Drop), 11: AF Class2 (Low Drop), 12: AF Class2 (Medium Drop) 13: AF Class2 (High Drop), 14: AF Class3 (Low Drop), 15: AF Class3 (Medium Drop), 16: AF Class3 (High Drop) 17: AF Class4 (Low Drop), 18: AF Class4 (Medium Drop), 19: AF Class4 (High Drop), 20: EF Class
<code>-V <1/2/3></code>	Show the rule in the specified class.

Example

```
> qos class -c 2 -n draytek -a -m 1 -l 192.168.1.50:192.168.1.80
```

```
Following setting will set in the class2
class 2 name set to draytek
Add a rule in class2
Class2 the 1 rule enabled
Set local address type to Range, 192.168.1.50:192.168.1.80
```

Telnet Command: qos type

This command allows user to configure protocol type and port number for QoS.

Syntax

```
qos type [-a <service name> | -e <no> | -d <no>].
```

Syntax Description

Parameter	Description
-----------	-------------

<i>-a <name></i>	It means to add rule.
<i>-e <no></i>	It means to edit user defined service type. "no" means the index number. Available numbers are 1-40.
<i>-d <no></i>	It means to delete user defined service type. "no" means the index number. Available numbers are 1-40.
<i>-n <name></i>	It means the name of the service.
<i>-t <type></i>	It means protocol type. 6: tcp(default) 17: udp 0: tcp/udp <1-254>: other
<i>-p <port></i>	It means service port. The typing format must be [start:end] (ex., 510:330).
<i>-l</i>	List user defined types. "no" means the index number. Available numbers are 1-40.

Example

```
> qos type -a draytek -t 6 -p 510:1330

service name set to draytek
service type set to 6:TCP
Port type set to Range
Service Port set to 510 ~ 1330
>
```

Telnet Command: qos voip

This command allows user to enable or disable the QoS for VoIP and RTP.

Syntax

`qos voip <on/off>`

Syntax Description

Parameter	Description
<i>on/off</i>	On - Enable the QoS for VoIP. Off - Disable th QoS for VoIP.

Example

```
> qos voip off
QoS for VoIP: Disable; SIP Port: 5060
>
```

Telnet Command: quit

This command can exit the telnet command screen.

Telnet Command: show lan

This command displays current status of LAN IP address settings.

Example

```
> show lan
The LAN settings:
Status   IP                Mask                DHCP Start IP      Pool Gateway
-----
[V]LAN1  192.168.1.1      255.255.255.0     V   192.168.1.10     200
192.168.1.1
[X]LAN2  192.168.2.1      255.255.255.0     V   192.168.2.10     100
192.168.2.1
[X]LAN3  192.168.3.1      255.255.255.0     V   192.168.3.10     100
192.168.3.1
[X]LAN4  192.168.4.1      255.255.255.0     V   192.168.4.10     100
192.168.4.1
[X]LAN5  192.168.5.1      255.255.255.0     V   192.168.5.10     100
192.168.5.1
[X]LAN6  192.168.6.1      255.255.255.0     V   192.168.6.10     100
192.168.6.1
[X]LAN7  192.168.7.1      255.255.255.0     V   192.168.7.10     100
192.168.7.1
[X]LAN8  192.168.8.1      255.255.255.0     V   192.168.8.10     100
192.168.8.1
[X]LAN9  192.168.9.1      255.255.255.0     V   192.168.9.10     100
192.168.9.1
[X]LAN10 192.168.10.1     255.255.255.0     V   192.168.10.10    100
192.168.10.1
[X]LAN11 192.168.11.1     255.255.255.0     V   192.168.11.10    100
192.168.11.1
[X]LAN12 192.168.12.1     255.255.255.0     V   192.168.12.10    100
192.168.12.1
[X]LAN13 192.168.13.1     255.255.255.0     V   192.168.13.10    100
192.168.13.1
[X]LAN14 192.168.14.1     255.255.255.0     V   192.168.14.10    100
192.168.14.1
[X]LAN15 192.168.15.1     255.255.255.0     V   192.168.15.10    100
192.168.15.1
[X]LAN16 192.168.16.1     255.255.255.0     V   192.168.16.10    100
192.168.16.1
[X]LAN17 192.168.17.1     255.255.255.0     V   192.168.17.10    100
192.168.17.1
[X]LAN18 192.168.18.1     255.255.255.0     V   192.168.18.10    100
192.168.18.1
[X]LAN19 192.168.19.1     255.255.255.0     V   192.168.19.10    100
192.168.19.1

[X]LAN20 192.168.20.1     255.255.255.0     V   192.168.20.10    100
192.168.20.1

--- MORE ---  ['q': Quit, 'Enter': New Lines, 'Space Bar': Next Page] ---
```

Telnet Command: show dmz

This command displays current status of DMZ host.

Example

```
> show dmz
%      WAN1 DMZ mapping status:
Index  Status  WAN1 aux IP    Private IP
-----
      1   Disable 0.0.0.0

%      WAN2 DMZ mapping status:
Index  Status  WAN2 aux IP    Private IP
-----
      1   Disable 0.0.0.0

%      WAN3 DMZ mapping status:
Index  Status  WAN3 aux IP    Private IP
-----
      1   Disable 111.251.202.195

%      WAN4 DMZ mapping status:
Index  Status  WAN4 aux IP    Private IP
-----
      1   Disable 0.0.0.0

%      WAN5 DMZ mapping status:
Index  Status  WAN5 aux IP    Private IP
-----
      1   Disable 172.16.2.191
...
...
%      WAN12 DMZ mapping status:

Index  Status  WAN12 aux IP   Private IP
-----

      1   Disable 0.0.0.0

>
```

Telnet Command: show dns

This command displays current status of DNS setting.

Example

```
> show dns
%%      Domain name server settings:
% LAN1 Primary DNS: [Not set]
% LAN1 Secondary DNS: [Not set]
```

```

...
...
% LAN100 Primary DNS: [Not set]
% LAN100 Secondary DNS: [Not set]
>

```

Telnet Command: show openport

This command displays current status of open port setting.

Example

```

> show openport ?
%%      Openport settings:
Index  Status  Comment          Local IP Address
*****
  1.   Enable  CARR_1           192.168.1.9
Total 1 items listed.

```

Telnet Command: show nat

This command displays current status of NAT.

Example

```

> show nat
Port Redirection Running Table:
Index  Protocol  Public Port  Private IP      Private Port
-----
  1      6         20011      192.168.100.10  8080
  2      6         20022      192.168.100.10  8443
  3      0          0          0.0.0.0         0
  4      0          0          0.0.0.0         0
  5      0          0          0.0.0.0         0
  6      0          0          0.0.0.0         0
  7      0          0          0.0.0.0         0
  8      0          0          0.0.0.0         0
  9      0          0          0.0.0.0         0
--- MORE ---  ['q': Quit, 'Enter': New Lines, 'Space Bar': Next Page]
....

```

Telnet Command: show portmap

This command displays the table of NAT Active Sessions.

Example

```

> show portmap
-----
P      Private_IP: Port      Pseudo_IP: Port      Peer_IP:Port ST LastTime DPK

```

```

-----
 6 192.168.100.10:57410 111.251.202.195:57730 52.159.49.199: 443 6 1165 1
 6 192.168.100.10:56901 172.16.2.191:57221 172.16.2.8: 3000 6 3823 1
17 192.168.100.10:55373 111.251.202.195:55693 224.0.0.252: 5355 0 293 0
17 192.168.100.10:55374 111.251.202.195:55694 172.217.160.67: 443 0 294 1
17 192.168.100.10:56529 111.251.202.195:56849 239.255.255.250: 1900 0
...

```

Telnet Command: show pmtime

This command displays the reuse time of NAT session.

Level0: It is the default setting.

Level1: It will be applied when the NAT sessions are smaller than 25% of the default setting.

Level2: It will be applied when the NAT sessions are smaller than the eighth of the default setting.

Example

```

> show pmtime
Level0 TCP=86400001 UDP=300001 ICMP=10001
Level1 TCP=600000 UDP=90000 ICMP=7000
Level2 TCP=60000 UDP=30000 ICMP=5000

```

Telnet Command: show session

This command displays current status of current session.

Example

```

> show session
% Maximum Session Number: 300000
% Maximum Session Usage: 2
% Current Session Usage: 2
% Current Session Used(include waiting for free): 15
% WAN1 Current Session Usage: 0
% WAN2 Current Session Usage: 0
% WAN3 Current Session Usage: 1
% WAN4 Current Session Usage: 0
% WAN5 Current Session Usage: 1
% WAN6 Current Session Usage: 0
% WAN7 Current Session Usage: 0
% WAN8 Current Session Usage: 0
% WAN9 Current Session Usage: 0
% WAN10 Current Session Usage: 0
% WAN11 Current Session Usage: 0
% WAN12 Current Session Usage: 0
## Session Create this Sec: 0
## Session Create Peak Sec: 17

```

Telnet Command: show status

This command displays current status of LAN and WAN connections.

Example

```
> show status
System Uptime:2:8:29
LAN Status
Primary DNS:168.95.192.1      Secondary DNS:168.95.1.1
IP Address:192.168.100.1      Tx Rate:103850      Rx Rate:68112

WAN 1 Status: Disconnected
Enable:Yes      Line:Fiber      Name:
Mode:DHCP Client Up Time:0:00:00      IP:---      GW IP:---
TX Packets:0      TX Rate(bps):0      RX Packets:0      RX
Rate(bps):0

WAN 2 Status: Disconnected
Enable:No      Line:Ethernet      Name:
Mode:---      Up Time:0:00:00      IP:---      GW IP:---
TX Packets:0      TX Rate(bps):0      RX Packets:0      RX
Rate(bps):0

WAN 3 Status: Connected
Enable:Yes      Line:Ethernet      Name:
Mode:PPPoE      Up Time:2:08:09      IP:111.251.202.195GW
IP:168.95.98.254
TX Packets:47380      TX Rate(bps):2600      RX Packets:59135      RX
Rate(bps):5704

WAN 4 Status: Disconnected
Enable:No      Line:Ethernet      Name:
Mode:---      Up Time:0:00:00      IP:---      GW IP:---
TX Packets:0      TX Rate(bps):0      RX Packets:0      RX
Rate(bps):0
...
...
```

Telnet Command: show traffic

This command can display traffic graph for WAN#, transmitted bytes, received bytes and sessions.

Syntax

```
show traffic <wan1/wan2~wan7><tx/rx> <weekly>
show traffic <ipaddr> <tx/rx>
show traffic session <weekly>
show traffic ip [1/0]
```

Example

```

WAN2 total TX: 0 Bytes ,RX: 0 Bytes
WAN3 total TX: 2 MB ,RX: 25 MB
WAN4 total TX: 0 Bytes ,RX: 0 Bytes
WAN5 total TX: 11 MB ,RX: 65 MB
WAN6 total TX: 0 Bytes ,RX: 0 Bytes
WAN7 total TX: 0 Bytes ,RX: 0 Bytes
WAN8 total TX: 0 Bytes ,RX: 0 Bytes
WAN9 total TX: 0 Bytes ,RX: 0 Bytes
WAN10 total TX: 0 Bytes ,RX: 0 Bytes
WAN11 total TX: 0 Bytes ,RX: 0 Bytes
WAN12 total TX: 0 Bytes ,RX: 0 Bytes
WAN13 total TX: 0 Bytes ,RX: 0 Bytes
WAN14 total TX: 0 Bytes ,RX: 0 Bytes
WAN15 total TX: 0 Bytes ,RX: 0 Bytes
WAN16 total TX: 0 Bytes ,RX: 0 Bytes
WAN17 total TX: 0 Bytes ,RX: 0 Bytes
WAN18 total TX: 0 Bytes ,RX: 0 Bytes
WAN19 total TX: 0 Bytes ,RX: 0 Bytes
WAN20 total TX: 0 Bytes ,RX: 0 Bytes
WAN21 total TX: 0 Bytes ,RX: 0 Bytes
WAN22 total TX: 0 Bytes ,RX: 0 Bytes
WAN23 total TX: 0 Bytes ,RX: 0 Bytes

WAN24 total TX: 0 Bytes ,RX: 0 Bytes
--- MORE ---  ['q': Quit, 'Enter': New Lines, 'Space Bar': Next Page] ---

```

Telnet Command: `srv dhcp dhcp2`

This command is used for configuring which method (LAN interface or MAC address) that the DHCP server on IP routed LAN shall use for assigning an IP address to the IP routed LAN clients.

Syntax

```
srv dhcp dhcp2 [-<command> <parameter> | ... ]
```

Syntax Description

Parameter	Description
<i>[<command></i> <i><parameter>/...]</i>	The available commands with parameters are listed below. <i>[...]</i> means that you can type in several commands in one line.
<i>-l <enable></i>	The DHCP server assigns the IP addresses to the clients via LAN port. <i><enable></i> : Enter 0 (disable) or 1 (enable).
<i>-m <enable></i>	The DHCP server assigns the IP addresses to the clients via MAC address configuration. <i><enable></i> : Enter 0 (disable) or 1 (enable).
<i>-e <id></i>	Turn on the flag of LAN 1 or LAN 2 if LAN port is enabled. <i><id></i> : Enter 3 or 4.
<i>-d <id></i>	Turn off the flag of LAN port 1 or LAN port 2. <i><id></i> : Enter 3 or 4.
<i>-v</i>	View current status.

Example

```

> srv dhcp dhcp2 -l 1 -e 1,2
> srv dhcp dhcp2 -v
  2nd DHCP server flag status --
    Server works on specified MAC address: ON
    Server works on specified LAN port: ON
    Port 3 flag: ON
    Port 4 flag: ON
>

```

Telnet Command: `srv dhcp public`

This command allows users to configure DHCP server for second subnet.

Syntax

`srv dhcp public start <IP address>`

`srv dhcp public cnt <IP counts>`

`srv dhcp public status`

`srv dhcp public add <MAC Addr XX-XX-XX-XX-XX-XX>`

`srv dhcp public del <MAC Addr XX-XX-XX-XX-XX-XX/all/ALL>`

Syntax Description

Parameter	Description
<code>start<IP address></code>	It means the starting point of the IP address pool for the DHCP server. <IP address> - Specify an IP address as the starting point in the IP address pool.
<code>cnt<IP counts></code>	It means the IP count number. <IP counts>- Specify the number of IP addresses in the pool. The maximum is 10.
<code>status</code>	It means the execution result of this command.
<code>add <MAC Addr XX-XX-XX-XX-XX-XX></code>	It means creating a list of hosts to be assigned. <MAC Addr XX-XX-XX-XX-XX-XX>: Specify MAC Address of the host.
<code>del <MAC Addr XX-XX-XX-XX-XX-XX/all/ALL></code>	It means removing the selected MAC address. <MAC Addr XX-XX-XX-XX-XX-XX>: Specify MAC Address of the host. all/ALL: It means all of the MAC addresses.

Example

```

> srv dhcp public cnt 3
> srv dhcp public add 14-49-BC-0D-1F-48
> srv dhcp public status
Index  MAC Address
0.     14-49-BC-0D-1F-48 !!!

```

Telnet Command: `srv dhcp dns1`

This command allows users to set Primary IP Address for DNS Server in LAN.

Syntax

`srv dhcp dns1 <lan1/lan2/..lan100> <DNS IP address>`

Syntax Description

Parameter	Description
<i><lan1/lan2/.../lan100></i>	It means to sepcify the LAN interface for setting the DNS server.
<i><DNS IP address></i>	It means the IP address that you want to use as DNS1. Note: The IP Routed Subnet DNS must be the same as NAT Subnet DNS).

Example

```
> srv dhcp dns1 lan8 168.95.1.1
% srv dhcp dns1 lan8 <DNS IP address>
% Now: 168.95.1.1
>
```

Telnet Command: `srv dhcp dns2`

This command allows users to set Secondary IP Address for DNS Server in LAN.

Syntax

`srv dhcp dns2 <lan1/lan2/.../lan100> <DNS IP address>`

Syntax Description

Parameter	Description
<i><lan1/lan2/.../lan100></i>	It means to sepcify the LAN interface for setting the DNS server.
<i><DNS IP address></i>	It means the IP address that you want to use as DNS2. Note: The IP Routed Subnet DNS must be the same as NAT Subnet DNS).

Example

```
> srv dhcp dns2 lan12 10.1.1.1
% srv dhcp dns2 lan12 <DNS IP address>
% Now: 10.1.1.1
>
```

Telnet Command: `srv dhcp frcdnsmanl`

This command can force the router to invoke DNS Server IP address.

Syntax

`srv dhcp frcdnsmanl on`

`srv dhcp frcdnsmanl off`

Syntax Description

Parameter	Description
<i>on</i>	It means to use manual setting for DNS setting.
<i>Off</i>	It means to use auto settings acquired from ISP.

Example

```
> srv dhcp frcdnsmanl on
% Domain name server now is using manual settings!
> srv dhcp frcdnsmanl off
% Domain name server now is using auto settings!
```

Telnet Command: `srv dhcp gateway`

This command allows users to specify gateway address for DHCP server.

Syntax

`srv dhcp gateway <Gateway IP>`

Syntax Description

Parameter	Description
<i><Gateway IP></i>	It means to specify a gateway address used for DHCP server.

Example

```
> srv dhcp gateway 192.168.2.1
This setting will take effect after rebooting.
Please use "sys reboot" command to reboot the router.
```

Telnet Command: `srv dhcp ipcnt`

This command allows users to specify IP counts for DHCP server.

Syntax

```
srv dhcp ipcnt <IP counts>
```

Syntax Description

Parameter	Description
<IP counts>	It means the number (0 to 256) that you have to specify for the DHCP server.

Example

```
> srv dhcp ipcnt ?  
% srv dhcp ipcnt <IP counts>  
% Now: 150
```

Telnet Command: `srv dhcp off`

This function allows users to turn off DHCP server. It needs rebooting router, please type "sys reboot" command to reboot router.

Telnet Command: `srv dhcp on`

This function allows users to turn on DHCP server. It needs rebooting router, please type "sys reboot" command to reboot router.

Telnet Command: `srv dhcp relay`

This command allows users to set DHCP relay setting.

Syntax

```
srv dhcp relay servip <server ip>  
srv dhcp relay 2nd_servip <server ip>  
srv dhcp relay subnet <index>
```

Syntax Description

Parameter	Description
<server ip>	It means the IP address that you want to used as DHCP server.
<index>	It means subnet 1 or 2. Please type 1 or 2. The router will invoke this function according to the subnet 1 or 2 specified here.

Example

```
> srv dhcp relay servip 192.168.1.46  
> srv dhcp relay subnet 2  
> srv dhcp relay servip ?  
% srv dhcp relay servip <server ip>  
% Now: 192.168.1.46
```

Telnet Command: `srv dhcp startip`

Syntax

`srv dhcp startip <IP address>`

Syntax Description

Parameter	Description
<code><IP address></code>	It means the IP address that you can specify for the DHCP server as the starting point.

Example

```
> srv dhcp startip 192.168.1.53
This setting will take effect after rebooting.
Please use "sys reboot" command to reboot the router.
```

Telnet Command: `srv dhcp status`

This command can display general information for the DHCP server, such as IP address, MAC address, leased time, host ID and so on.

Syntax

`srv dhcp status <LAN1/2/3/.../100/ip_routed_subnet>`

Syntax Description

Parameter	Description
<code><LAN1/2/3/.../100/ip_routed_subnet></code>	It means to display current status for the selected interface.

Example

```
> srv dhcp status
LAN1      : DHCP Server On   IP Pool: 192.168.1.10 ~ 192.168.1.209
           Default Gateway: 192.168.1.1
-----
Index  IP Address      MAC Address          Leased Time      HOST ID
-----
LAN1
1      192.168.1.10   08-BF-B8-D5-DD-A9   69:01:37         A1000460>
```

Telnet Command: `srv dhcp leasetime`

This command can set the lease time for the DHCP server.

Syntax

`srv dhcp leasetime <Lease Time (sec)>`

Syntax Description

Parameter	Description
<code><Lease Time (sec)></code>	It means the lease time that DHCP server can use. The unit is second.

Example

```
> srv dhcp leasetime ?
% srv dhcp leasetime <Lease Time (sec.)>
% Now: 259200
>
```

Telnet Command: `srv dhcp nodetype`

This command can set the node type for the DHCP server.

Syntax

`srv dhcp nodetype <count>`

Syntax Description

Parameter	Description
<code><count></code>	It means to specify a type for node. 1. B-node 2. P-node 4. M-node 8. H-node

Example

```
> srv dhcp nodetype 1
> srv dhcp nodetype ?
%% srv dhcp nodetype <count>
%% 1. B-node 2. P-node 4. M-node 8. H-node
% Now: 1
```

Telnet Command: `srv dhcp primWINS`

This command can set the primary IP address for the DHCP server.

Syntax

```
srv dhcp primWINS <WINS IP address>
```

```
srv dhcp primWINS clear
```

Syntax Description

Parameter	Description
<WINS IP address>	It means the IP address of primary WINS server.
<i>clear</i>	It means to remove the IP address settings of primary WINS server.

Example

```
> srv dhcp primWINS 192.168.1.88
> srv dhcp primWINS ?
%% srv dhcp primWINS <WINS IP address>
%% srv dhcp primWINS clear
% Now: 192.168.1.88
```

Telnet Command: `srv dhcp secWINS`

This command can set the secondary IP address for the DHCP server.

Syntax

```
srv dhcp secWINS <WINS IP address>
```

```
srv dhcp secWINS clear
```

Syntax Description

Parameter	Description
<WINS IP address>	It means the IP address of secondary WINS server.
<i>clear</i>	It means to remove the IP address settings of second WINS server.

Example

```
> srv dhcp secWINS 192.168.1.180
> srv dhcp secWINS ?
%% srv dhcp secWINS <WINS IP address>
%% srv dhcp secWINS clear
% Now: 192.168.1.180
```

Telnet Command: `srv dhcp expired_RecycleIP`

This command can set the time to check if the IP address can be assigned again by DHCP server or not.

Syntax

```
srv dhcp expRecycleIP <sec time>
```

Syntax Description

Parameter	Description
<sec time>	It means to set the time (5-300 seconds) for checking if the IP can be assigned again or not.

Example

```
> srv dhcp expRecycleIP 250
% DHCP expired_RecycleIP = 250
```

Telnet Command: `srv dhcp tftp`

This command can set the TFTP server as the DHCP server.

Syntax

```
srv dhcp tftp <TFTP server name>
```

Syntax Description

Parameter	Description
<TFTP server name>	It means to type the name of TFTP server.

Example

```
> srv dhcp tftp TF123
> srv dhcp tftp ?
%% srv dhcp tftp <TFTP server name>
% Now: TF123
```

Telnet Command: `srv dhcp tftpdcl`

This command can remove the name defined for the TFTP server.

Syntax

```
srv dhcp tftpdcl
```

Example

```
> srv dhcp tftp TF123
> srv dhcp tftp ?
%% srv dhcp tftp <TFTP server name>
% Now: TF123
> srv dhcp tftpdcl
% The TFTP Server Name had been deleted !!!
```

Telnet Command: `srv dhcp option`

This command can set the custom option for the DHCP server.

Syntax

`srv dhcp option -h`

`srv dhcp option -l`

`srv dhcp option -d <idx>`

`srv dhcp option -e <1 or 0> -i <lan number> -s <Next Server IP Address>`

`srv dhcp option -e <1 or 0> -i <lan number> -c <option number> -v <option value>`

`srv dhcp option -e <1 or 0> -i <lan number> -c <option number> -x <option value>`

`srv dhcp option -e <1 or 0> -i <lan number> -c <option number> -a <option value>`

`srv dhcp option -u <idx unumber>`

Syntax Description

Parameter	Description
<code>-h</code>	It means to display usage of this command.
<code>-l</code>	It means to display all the user defined DHCP options.
<code>-d <idx></code>	It means to delete the option number by specifying its index number.
<code>-e <1 or 0></code>	It means to enable/disable custom option feature. 1:enable 0:disable
<code>-i <lan number></code>	<code><lan number></code> : It means to specify the LAN interface. 1: lan1 a: all LAN r: routed subnet
<code>-s <Next Server IP Address></code>	It means to set the next server IP address. Next Server IP Address: Enter an IP address.
<code>-c <option number></code>	It means to set option number. Available number ranges from 0 to 255. option number: Enter a number.
<code>-v <option value></code>	It means to set option number by typing string. option value: Enter a string.
<code>-x <option value></code>	It means to set option number with the format of Hexadecimal characters. option value: Enter a number (hex).
<code>-a <option value></code>	It means to set the option value by specifying the IP address. option value: Enter an IP address.
<code>-u <idx number></code>	It means to update the option value of the sepecified index. idx number: Enter the index number of the option value.

Example

```
> srv dhcp option -e 1 -c 18 -v /path
> srv dhcp option -l
% state  idx interface      opt type  data
% enable 1  ALL LAN      18 ASCII  /path
```

Telnet Command: `srv nat dmz`

This command allows users to set DMZ host. Before using this command, please set WAN IP Alias first.

Syntax

`srv nat dmz n m [-<command> <parameter> | ...]`

Syntax Description

Parameter	Description
<i>n</i>	It means to map selected WAN IP to certain host. 1: wan1 2: wan2
<i>m</i>	It means the index number (1 ~300) of the DMZ host. Default setting is "1" (WAN 1). It is only available for Static IP mode. If you use other mode, you can set 1 ~ 8 in this field. If WAN IP alias has been configured, then the number of DMZ host can be added more.
<i>[<command> <parameter> ...]</i>	The available commands with parameters are listed below. <i>[...]</i> means that you can type in several commands in one line.
<i>-e</i>	It means to enable/disable such feature. 1:enable 0:disable
<i>-i</i>	It means to specify the private IP address of the DMZ host.
<i>-r</i>	It means to remove DMZ host setting.
<i>-v</i>	It means to display current status.

Example

```
> srv nat dmz 1 1 -i 192.168.1.96
> srv nat dmz -v
%      WAN1 DMZ mapping status:
Index Status WAN1 aux IP   Private IP
-----
  1   Disable 0.0.0.0 192.168.1.96

%      WAN2 DMZ mapping status:
Index Status WAN2 aux IP   Private IP
-----
  1   Disable 0.0.0.0

%      WAN3 DMZ mapping status:
Index Status WAN3 aux IP   Private IP
-----
  1   Disable 118.166.171.215
...
```

Telnet Command: `srv nat ipsecpass`

This command allows users to enable or disable IPSec ESP tunnel passthrough and IKE source port (500) preservation.

Syntax

srv nat ipsecpass <options>

Syntax Description

Parameter	Description
<options>	The available commands with parameters are listed below.
on	It means to enable IPsec ESP tunnel passthrough and IKE source port (500) preservation.
off	It means to disable IPsec ESP tunnel passthrough and IKE source port (500) preservation.
status	It means to display current status for checking.

Example

```
> srv nat ipsecpass status
%% Status: IPsec ESP pass-thru and IKE src_port:500 preservation is
OFF.
```

Telnet Command: srv nat openport

This command allows users to set open port settings for NAT server.

Syntax

srv nat openport n m [-<command> <parameter> | ...]

Syntax Description

Parameter	Description
n	It means the index number for the profiles. The range is from 1 to 260.
m	It means to specify the sub-item number for this profile. The range is from 1 to 10.
[<command> <parameter> ...]	The available commands with parameters are listed below. [...] means that you can type in several commands in one line.
-a <enable>	It means to enable or disable the open port rule profile. 0: disable 1:enable
-c <comment>	It means to type the description (less than 23 characters) for the defined network service.
-l <source ip idx>	It means to set source IP object. 1 to 192: for IP object 1 to 32: for IP group 0: Any For example: srv nat openport 1 1 -l 1 -g 0
-g <source ip type>	It means to set IP type. 0: IP object 1: IP group For example: srv nat openport 1 1 -l 1 -g 0
-i <local ip>	It means to set the IP address for local computer. Local ip: Type an IP address in this field.
-w <widx><ipidx>	widx: Specify the public IP.

	1: WAN1 Default, 2: WAN2, ...and so on. ipidx: Specify the index number of an alias IP (1 to 32).
<i>-p <protocol></i>	Specify the transport layer protocol. Available values are TCP, UDP and ALL.
<i>-s <start port></i>	It means to specify the starting port number of the service offered by the local host. The range is from 0 to 65535.
<i>-e <end port></i>	It means to specify the ending port number of the service offered by the local host. The range is from 0 to 65535.
<i>-v</i>	It means to display current settings.
<i>-r <idx></i>	It means to delete the specified open port setting. idx: Enter the index number of the profile.
<i>-f <idx></i>	It means to return to factory settings for all the open ports profiles.

Example

```

> srv nat openport 1 1 -a 1 -c games -i 192.168.1.55 -w 1 1 -p TCP -s 56 -e
83
Set WAN Port ok!!

> srv nat openport 1 1 -v
%% Status: Enable
%% Comment: games
%% WAN Interface: WAN1
%% Private IP address: 192.168.1.55
Index  Protocol      Start Port      End Port
*****
  1.    TCP          56              83
>
>

```

Telnet Command: *srv nat portmap*

This command allows users to set port redirection table for NAT server.

Syntax

srv nat portmap add <idx> <serv name> <proto> <pub port> <src ip type> <src ip idx> <pri ip> <pri port> <wan idx> <alias IP>

srv nat portmap del <idx>

srv nat portmap disable <idx>

srv nat portmap enable <idx> <proto>

srv nat portmap flush

srv nat portmap table

srv nat portmap view

Syntax Description

Parameter	Description
<i>add <idx></i>	It means to add a new port redirection table with an index number.

	Available index number is from 1 to 260.
<i>serv name</i>	It means to type one name as service name.
<i>proto</i>	It means to specify TCP or UDP as the protocol.
<i>pub port</i>	It means to specify which port (0-65535) can be redirected to the specified Private IP and Port of the internal host.
<i>src ip type</i>	It means to specify the IP type (object or group). ip type: 0 means IP object; 1 means IP group.
<i>src ip idx</i>	It means to specify the index number of the object profile. ip idx: 1 to 192 for IP object profile; 1 to 32 for IP group profile. 0 means any object or group.
<i>pri ip</i>	It means to specify the private IP address of the internal host providing the service.
<i>pri port</i>	It means to specify the private port number (1-65535) of the service offered by the internal host.
<i>wan idx</i>	It means to specify WAN interface for the port redirection. Idx: wan1 to wan12, all
<i>alias ip</i>	It means to specify an alias IP by entering the index number (1 to 32). ip: 1 to 32.
<i>del <idx></i>	It means to remove the selected port redirection setting.
<i>disable <idx></i>	It means to inactivate the selected port redirection setting.
<i>enable <idx> <proto></i>	It means to activate the selected port redirection setting.
<i>flush</i>	It means to clear all the port mapping settings.
<i>table</i>	It means to display Port Redirection Configuration Table.

Example

```
> srv nat portmap add 1 name tcp 100 0 0 192.168.1.10 200 wan1 1
> srv nat portmap table

NAT Port Redirection Configuration Table:

Index  Service Name  Protocol  Public Port  Private IP      Private Port ifno
1      name          TCP       100         192.168.1.10   20
0      -1
2      ACS https     TCP       20022      192.168.100.10 844
3      -2
...
...

ifno: 0 = all, 3 = wan1, 4 = wan2
>
```

Telnet Command: `srv nat trigger`

This command allows users to configure port triggering settings for NAT.

Syntax

```
srv nat trigger setdefault
```

```
srv nat trigger view
```

```
srv nat trigger n [-<command> <parameter> | ... ]
```

Syntax Description

Parameter	Description
<i>setdefault</i>	Set to factory default settings.
<i>view</i>	Display all of the port triggering settings.
<i>n</i> <i><command><parameter> ...]</i>	"n" means the rule number. The available commands with parameters are listed below. [...] means that you can type in several commands in one line.
<i>-c <XXX></i>	Type a comment for such rule if required.
<i>-e <0/1></i>	Enable (1) or disable (0) a rule (specified with rule number).
<i>-g<0/1></i>	Set the source IP type. 0 - IP object 1 - IP group
<i>-p <1/2/3></i>	Specify the protocol for such trigger rule. 1 - TCP 2 - UDP 3 - All
<i>-t</i>	Specify the port number (0-65535) for trigger.
<i>-P</i>	Specify the incoming protocol for such trigger rule. 1 - TCP 2 - UDP 3 - All
<i>-i</i>	Specify the port number (0-65535) for incoming protocol.
<i>-d</i>	Delete the selected trigger rule.
<i>-v</i>	Display the port trigger settings for specified rule.

Example

```
> srv nat trigger 1 -c after_dinner
> srv nat trigger 1 -e 1
> srv nat trigger 1 -p 1
> srv nat trigger 1 -t 2000
> srv nat trigger 1 -P 2
> srv nat trigger 1 -i 3000
> srv nat trigger 1 -v
```

```
Port Trigger Rule Index:1
```

```
Status:Enable
```

```
Comment:after_dinner2000
```

```

Triggering Protocol:TCP
Triggering Port:2000
Incoming Protocol:UDP
Incoming Port:3000

```

Telnet Command: `srv nat status`

This command allows users to view NAT Port Redirection Running Table.

Example

```

> srv nat status
NAT Port Redirection Running Table:

Index Protocol Public Port Private IP Private Port
1      6      80    192.168.1.11    100
2      0      0     0.0.0.0         0
3      0      0     0.0.0.0         0
4      0      0     0.0.0.0         0
5      0      0     0.0.0.0         0
6      0      0     0.0.0.0         0
7      0      0     0.0.0.0         0
8      0      0     0.0.0.0         0
9      0      0     0.0.0.0         0
10     0      0     0.0.0.0         0
11     0      0     0.0.0.0         0
12     0      0     0.0.0.0         0
13     0      0     0.0.0.0         0
14     0      0     0.0.0.0         0
15     0      0     0.0.0.0         0
16     0      0     0.0.0.0         0
17     0      0     0.0.0.0         0
18     0      0     0.0.0.0         0
19     0      0     0.0.0.0         0

20     0      0     0.0.0.0         0

--- MORE ---  ['q': Quit, 'Enter': New Lines, 'Space Bar': Next Page]
---

```

Telnet Command: `srv nat showall`

This command allows users to view a summary of NAT port redirection setting, open port and DMZ settings.

Example

```

> srv nat showall ?
Index Proto WAN IP:Port Private IP:Port Act
*****
R01 TCP 0.0.0.0:25600 192.168.1.10:51200 Y
R02 TCP -- ALL --:13902 192.168.100.10:64288 Y

O01 --- 0.0.0.0:800~900 192.168.1.100:800~900 Y
O01 --- 0.0.0.0:0~0 192.168.1.100:0~0 Y

```

O01	---	0.0.0.0:0~0	192.168.1.100:0~0	Y
O01	---	0.0.0.0:0~0	192.168.1.100:0~0	Y
O01	---	0.0.0.0:0~0	192.168.1.100:0~0	Y
O01	---	0.0.0.0:0~0	192.168.1.100:0~0	Y
O01	---	0.0.0.0:0~0	192.168.1.100:0~0	Y
O01	---	0.0.0.0:0~0	192.168.1.100:0~0	Y
O01	---	0.0.0.0:0~0	192.168.1.100:0~0	Y
O01	---	0.0.0.0:0~0	192.168.1.100:0~0	Y
D01	All	0.0.0.0	192.168.1.96	Y

R:Port Redirection, O:Open Ports, D:DMZ

Telnet Command: `srv nat pseudoctl`

This command allows users to check the pseudo port number to prevent from port conflict.

Syntax

`srv nat pseudoctl session <value>`

`srv nat pseudoctl function <0-3>`

Syntax Description

Parameter	Description
<code>session <value></code>	Set the threshold of the session. <value>: 0 to 2147483647.
<code>function <0-3></code>	0: It means "Auto". Check the created pseudo port number automatically when the session number is over the threshold. 1: It means "Not". Create a pseudo port number based on subnet setting. No verification. 2: It means "Must". Check the created pseudo port number if it is used by other client. 3: Create a pseudo port number. No verification.

Example

```
> srv nat pseudoctl function 2
  pseudo port: get hash pseudo port + subnet.
  pseudo port search: check pseudo port(Must).
>
```

Telnet Command: `srv nat RSTTimeout`

This command is used for forwarding RST out via TCP after a period of time.

Syntax

`srv nat RSTTimeout <value>`

Syntax Description

Parameter	Description
<code><value></code>	Set the timeout value. <value>: 0 to 10 (one unit is 10msec).

Example

```
> srv nat RSTTimeout 2
Set timeout 2 unit
> srv nat RSTTimeout ?
%% srv RSTtimeout <value> (unit is 10msec). (0<=value<=10)
-----
now timeout set 2 unit
```

Telnet Command: switch -i

This command is used to obtain the TX (transmitted) or RX (received) data for each connected switch.

Syntax

```
switch -i <switch idx_no><option>
```

Syntax Description

Parameter	Description
<switch idx_no>	It means the index number of the switch profile.
<i>option</i>	The available commands with parameters are listed below. <i>cmd</i> <i>acc</i> <i>traffic [on/off/status/tx/rx]</i>
<i>cmd</i>	It means to send command to the client.
<i>acc</i>	It means to set the client authentication account and password.
<i>traffic</i> <on/off/status/tx/rx>	It means to turn on/off or display the data transmission from the client.

Example

```
> switch -i 1 traffic on
External Device NO. 1 traffic statistic function is enable
```

Telnet Command: switch status

This command is used to display current switch status.

Example

```
> switch status ?
External Device auto discovery status : Enable
No Respond to External Device : Enable
Display External Device syslog : Enable
>
```

Telnet Command: switch not_respond

This command is used to detect the external device automatically and display on this page.

Syntax

switch not_respond 0

switch not_respond 1

Syntax Description

Parameter	Description
0	Disable the option of "No Respond to External Device packets".
1	Enable the option of "No Respond to External Device packets".

Example

```
> switch not_respond 1
slave not respond!
>
```

Telnet Command: switch on

This command is used to turn on the auto discovery for external devices.

Example

```
> switch on
Enable Extrnal Device auto discovery!
```

Telnet Command: switch off

This command is used to turn off the auto discovery for external devices.

Example

```
> switch off
Disable External Device auto discovery!
```

Telnet Command: switch list

This command is used to display the connection status of the switch.

Example

```
> switch list?
No.      Mac          IP          status      Dur Time   CWMP   ACS_CTL  Model_Name  firmware_version
-----
[1] 00-1d-aa-0c-cd-08 192.168.1.11 On-Line    01:07:45   -1     -1     G2282x
```

Telnet Command: switch clear

This command is used to reset the switch table and reboot the router.

Syntax

switch clear <idx>

Syntax Description

Parameter	Description
<idx>	It means the index number of each item shown on the table.

	The range is from 1 to 8.
<i>-f</i>	It means to clear all of the data.

Example

```
> switch clear 1
Switch Data clear successful

> switch clear -f
Switch Data clear successful
```

Telnet Command: switch query

This command is used to enable or disable the switch query.

Example

```
> switch query on
Extern Device status query is Enable

> switch query off
Extern Device status query is Disable
```

Telnet Command: switch syslog

This command is used to save the switch log onto Syslog.

Example

```
> switch syslog on
External Device syslog is Enable
```

Telnet Command: sys admin

This command is used for RD engineer to access into test mode of Vigor router.

Telnet Command: sys adminuser

This command is used to create user account and specify LDAP server. The server will authenticate the local user who wants to access into the web user interface of Vigor router.

Syntax

sys adminuser <option>

Syntax Description

Parameter	Description
<i>option</i>	Available options includes: Local <0-1> LDAP <0-1> TACACS+ <0-1> fallback <0-1 > edit <INDEX> delete <INDEX> view <INDEX>
<i>Local<0-1></i>	0 - Disable the local user. 1 - Enable the local user.
<i>LDAP <0-1></i>	0 - Disable the LDAP.

	1 - Enable the LDAP.
<i>TACACS+ <0-1></i>	0 - Disable the TACACS+ service. 1 - Enable the TACACS+ service.
<i>Fallback <0-1></i>	0 - Disable the function of fallback to local. 1 - Enable the function of fallback to local.
<i>edit <INDEX> username password</i>	Edit an existed user account or create a new local user account. <INDEX>: 1 ~8. There are eight profiles to be added / edited. Username: Enter a new name for local user. Password: Enter a password for local user.
<i>delete <INDEX></i>	Delete a local user account.
<i>view <INDEX></i>	Show the user account/password detail information.

Example

```
> sys adminuser Local 1
Local User has enabled!
> sys adminuser LDAP 1
LDAP has enabled!
> sys adminuser edit 1 carrie test123
Updated!
> sys adminuser view 1

Index:1
User Name:carrie
User Password:test123
```

Telnet Command: sys board

This command is used to disable/enable and configure the panel control.

Syntax

```
sys board button def <on/off>
sys board button wlan <on/off>
sys board led control <on/off>
sys board led sleepMode <on/off>
sys board led sleepMode time <minute>
sys board usb <p1/p2> <on/off>
```

Syntax Description

Parameter	Description
<i>button def <on/off></i>	The default reset button will be invalid if turn it off. On - The button is valid. Off - The button is invalid.
<i>button wlan <on/off></i>	The wireless button will be invalid if turn it off. On - The button is valid. Off - The button is invalid.
<i>led control <on/off></i>	All LEDs on the front panel will be invalid if turn it off. On - The LEDs are valid.

	Off - The LEDs are invalid.
<i>led sleepMode <on/off></i>	All LEDs on the front panel will be set in sleep mode. On - The sleep mode is on. Off - The sleep mode is off. If the sleep mode is on, push the "wireless button" and the "factory reset button" to turn the LED on (even the buttons are disabled).
<i>led sleepMode time [minutes]</i>	After enabling the sleep mode for all LEDs, they will sleep after the minutes configured here. Minutes: Enter the number of the time.
<i>usb p1/p2 <on/off></i>	The USB port will be invalid if turn it off. On - The port is valid. Off - The port is invalid.

Example

```
> sys board led sleepMode on
LEDs Sleep Mode is on now.
> sys board led sleepMode time 10
Sleep Countdown Time set as 10 minute(s).
Reset the led sleep timer success..
```

Telnet Command: sys bonjour

This command is used to disable/enable and configure the Bonjour service.

Syntax

sys bonjour [-<command> <parameter> | ...]

Syntax Description

Parameter	Description
<i>[<command> <parameter> ...]</i>	The available commands with parameters are listed below. [...] means that you can type in several commands in one line.
<i>-e <enable></i>	It is used to disable/enable bonjour service (0: disable, 1: enable).
<i>-h <enable></i>	It is used to disable/enable http (web) service (0: disable, 1: enable).
<i>-t <enable></i>	It is used to disable/enable telnet service (0: disable, 1: enable).
<i>-f <enable></i>	It is used to disable/enable FTP service (0: disable, 1: enable).
<i>-s <enable></i>	It is used to disable/enable SSH service (0: disable, 1: enable).
<i>-p <enable></i>	It is used to disable/enable printer service (0: disable, 1: enable).
<i>-6 <enable></i>	It is used to disable/enable IPv6 (0: disable, 1: enable).

Example

```
> sys bonjour -s 1
>
```

Telnet Command: sys cfg

This command reset the router with factory default settings. When a user types this command, all the configuration will be reset to default setting.

Syntax

sys cfg default

sys cfg status

Syntax Description

Parameter	Description
<i>default</i>	It means to reset current settings with default values.
<i>status</i>	It means to display current profile version and status.

Example

```
> sys cfg status
Profile version: 4.0.7   Status: 1 (0x491e5e6c)
> sys cfg default
>
```

Telnet Command: sys cmdlog

This command displays the history of the commands that you have typed.

Example

```
> sys cmdlog
% Commands Log: (The lowest index is the newest !!!)
 [1] sys cmdlog
 [2] sys cmdlog ?
 [3] sys ?
 [4] sys cfg status
 [5] sys cfg ?
```

Telnet Command: sys ftpd

This command displays current status of FTP server.

Syntax

sys ftpd *on*

sys ftpd *off*

Syntax Description

Parameter	Description
<i>on</i>	It means to turn on the FTP server of the system.
<i>off</i>	It means to turn off the FTP server of the system.

Example

```
> sys ftpd on
% sys ftpd turn on !!!
```

Telnet Command: sys domainname

This command can set and remove the domain name of the system when DHCP mode is selected for WAN.

Syntax

`sys domainname <wan1/wan2> <Domain Name Suffix>`

`sys domainname <wan1/wan2> clear`

Syntax Description

Parameter	Description
<i>wan1/wan2</i>	It means to specify WAN interface for assigning a name for it.
<i>Domain Name Suffix</i>	It means the name for the domain of the system. The maximum number of characters that you can set is 39.
<i>clear</i>	It means to remove the domain name of the system.

Example

```
> sys domainname wan1 clever
> sys domainname wan2 intellegent
> sys domainname ?
% sys domainname <wan1/wan2> <Domain Name Suffix (max. 39 characters)>
% sys domainname <wan1/wan2> clear
% Now: wan1 == clever, wan2 ==intelligent
>
```

Telnet Command: sys iface

This command displays the current interface connection status (UP or Down) with IP address, MAC address and Netmask for the router.

Example

```
> sys iface
Interface 0 Ethernet:
Status: UP
IP Address: 192.168.1.1      Netmask: 0xFFFFFFFF00 (Private)
IP Address: 0.0.0.0        Netmask: 0xFFFFFFFF
MAC: 00-50-7F-00-00-00
Interface 4 Ethernet:
Status: DOWN
IP Address: 0.0.0.0        Netmask: 0x00000000
MAC: 00-50-7F-00-00-02
Interface 5 Ethernet:
Status: DOWN
IP Address: 0.0.0.0        Netmask: 0x00000000
MAC: 00-50-7F-00-00-03
Interface 6 Ethernet:
Status: DOWN
IP Address: 0.0.0.0        Netmask: 0x00000000
MAC: 00-50-7F-00-00-04
```

```

Interface 7 Ethernet:
Status: DOWN
IP Address: 0.0.0.0          Netmask: 0x00000000
MAC: 00-50-7F-00-00-05
Interface 8 Ethernet:
Status: DOWN
IP Address: 0.0.0.0          Netmask: 0x00000000
MAC: 00-50-7F-00-00-06

Interface 9 Ethernet:
Status: DOWN
IP Address: 0.0.0.0          Netmask: 0x00000000
MAC: 00-50-7F-00-00-07
--- MORE ---  ['q': Quit, 'Enter': New Lines, 'Space Bar': Next Page]
---
>

```

Telnet Command: sys name

This command can set and remove the name for the router when DHCP mode is selected for WAN.

Syntax

`sys name <wan1/wan2> <ASCII string>`

`sys name <wan1/wan2> clear`

Syntax Description

Parameter	Description
<i>wan1/wan2</i>	It means to specify WAN interface for assigning a name for it.
<i>ASCII string</i>	It means the name for router. The maximum character that you can set is 39.

Example

```

> sys name wan1 drayrouter
> sys name ?
% sys name <wan1/wan2> <ASCII string (max. 20 characters)>
% sys name <wan1/wan2> clear
% Now: wan1 == drayrouter, wan2 ==

```

Note: Such name can be used to recognize router's identification in SysLog dialog.

Telnet Command: sys passwd

This command allows users to set password for the administrator.

Syntax

`sys passwd <old password> <new password>`

Syntax Description

Parameter	Description
<i><old password> <new</i>	It means the password for administrator. The maximum character

<code>password></code>	that you can set is 83.
---------------------------	-------------------------

Example

```
> sys passwd admin123
>
```

Telnet Command: sys reboot

This command allows users to restart the router immediately.

Example

```
> sys reboot
>
```

Telnet Command: sys autoreboot

This command allows users to restart the router automatically within a certain time.

Syntax

`sys autoreboot <on/off/hour(s)>`

Syntax Description

Parameter	Description
<i>on/off</i>	On - It means to enable the function of auto-reboot. Off - It means to disable the function of auto-reboot.
<i>hours</i>	It means to set the time schedule for router reboot. For example, if you type "2" in this field, the router will reboot with an interval of two hours.

Example

```
> sys autoreboot on
autoreboot is ON
> sys autoreboot 2
autoreboot is ON
autoreboot time is 2 hour(s)
```

Telnet Command: sys commit

This command allows users to save current settings to FLASH. Usually, current settings will be saved in SRAM. Yet, this command will save the file to FLASH.

Example

```
> sys commit
>
```

Telnet Command: sys tftpd

This command can turn on TFTP server for upgrading the firmware.

Example

```
> sys tftpd
% TFTP server enabled !!!
```

Telnet Command: sys cc

This command can display current country code and wireless region of this device.

Example

```
> sys cc
Country Code      : 0x 0 [International]
Wireless Region Code: 0x30
>
```

Telnet Command: sys version

This command can display current version for the system.

Example

```
> sys version
Router Model: Vigor3912S   Version: 4.3.5 zh_TW zh_CN
Profile version: 4.0.7    Status: 1 (0x14bc0da9)
Router IP: 192.168.1.1    Netmask: 255.255.255.0
Firmware Build Date/Time: Nov 13 2023 16:38:20
Router Name: DrayTek
Revision: 3682_4564_a39c288 V400_RD3
>
```

Telnet Command: sys qrybuf

This command can display the system memory status and leakage list.

Example

```
> sys qrybuf
System Memory Status and Leakage List

Buf sk_buff ( 200B), used#: 1647, cached#: 30
Buf KMC4088 (4088B), used#: 0, cached#: 8
Buf KMC2552 (2552B), used#: 1641, cached#: 42
Buf KMC1016 (1016B), used#: 7, cached#: 1
Buf KMC504 ( 504B), used#: 8, cached#: 8
Buf KMC248 ( 248B), used#: 26, cached#: 22
Buf KMC120 ( 120B), used#: 67, cached#: 61
Buf KMC56 ( 56B), used#: 20, cached#: 44
Buf KMC24 ( 24B), used#: 58, cached#: 70
Dynamic memory: 13107200B; 4573168B used; 190480B/0B in level 1/2
cache.

FLOWTRACK Memory Status
# of free = 300000
# of maximum = 0
# of flowstate = 300000
```

```
# of lost by siganture = 0
# of lost by list = 0
```

Telnet Command: sys pollbuf

This command can turn on or turn off polling buffer for the router.

Syntax

```
sys pollbuf on
```

```
sys pollbuf off
```

Syntax Description

Parameter	Description
<i>on</i>	It means to turn on pulling buffer.
<i>off</i>	It means to turn off pulling buffer.

Example

```
> sys pollbuf on
% Buffer polling is on!

> sys pollbuf off
% Buffer polling is off!
```

Telnet Command: sys tr069

This command can set CPE settings for applying in VigorACS.

Syntax

```
sys tr069 get <parm> <option>
```

```
sys tr069 set <parm> <value>
```

```
sys tr069 getnoti <parm>
```

```
sys tr069 setnoti <parm> <value>
```

```
sys tr069 log
```

```
sys tr069 debug <on/off>
```

```
sys tr069 save
```

```
sys tr069 clear
```

```
sys tr069 inform <event code>
```

```
sys tr069 port <port num>
```

```
sys tr069 cert_auth <on/off>
```

```
sys tr069 only_standard_parm <on/off>
```

```
sys tr069 notify -S
```

```
sys tr069 notify -n <on/off>
```

```
sys tr069 notify -l <on/off>
```

```
sys tr069 notify -c <on/off>
```

```
sys tr069 notify -h <on/off>
```

```
sys tr069 notify -b <on/off>
```

sys tr069 notify -B "<WAN number> <Medium threthold> <High threthold> <TX Speed>Mb <RX Speed>Mb"

Syntax Description

Parameter	Description
<i>get [parm] [option]</i>	It means to get parameters for tr-069. option=<nextlevel>: only gets nextlevel for GetParameterNames.
<i>set [parm] [value]</i>	It means to set parameters for tr-069.
<i>getnoti [parm]</i>	It means to get parameter notification value.
<i>setnoti [parm] [value]</i>	It means to set parameter notification value.
<i>log</i>	It means to display the TR-069 log.
<i>debug [on/off]</i>	on: turn on the function of sending debug message to syslog. off: turn off the function of sending debug message to syslog.
<i>save</i>	It means to save the parameters to the flash memory of the router.
<i>clear</i>	It means to clear all tr069 parameters in the flash memory of the router.
<i>Inform [event code]</i>	It means to inform parameters for tr069 with different event codes. [event code] includes: 0-"0 BOOTSTRAP", 1-"1 BOOT", 2-"2 PERIODIC", 3-"3 SCHEDULED", 4-"4 VALUE CHANGE", 5-"5 KICKED", 6-"6 CONNECTION REQUEST", 7-"7 TRANSFER COMPLETE", 8-"8 DIAGNOSTICS COMPLETE", 9-"M Reboot"
<i>port [port num]</i>	It means to change tr069 listen port number.
<i>cert_auth [on/off]</i>	on: turn on certificate-based authentication. off: turn off certificate-based authentication.
<i>only_standard_parm <on/off></i>	It means to turn on or off to exclude all the Vendor-Specific ("X_") parameters, and only send out standard parameters.
<i>notify -n <on/off></i>	It means to set CPE notification settings. It means to / not to record the CPE notify log on the Syslog. on: Record on the Syslog. off: Not record on the Syslog.
<i>notify -l <on/off></i>	It means to / not to record the web login log on the Syslog. on: Record on the Syslog. off: Not record on the Syslog.
<i>notify -c <on/off></i>	It means to / not to record the web changed log on the Syslog. on: Record on the Syslog. off: Not record on the Syslog.
<i>notify -h <on/off></i>	It means to / not to record the high availability log on the Syslog. on: Record on the Syslog. off: Not record on the Syslog.
<i>notify -b [on/off]</i>	It means to / not to record the bandwidth utilization log on the Syslog.

	on: Record on the Syslog. off: Not record on the Syslog.
<i>notify -B "<WAN number> <Medium threthold> <High threthold> <TX Speed>Mb <RX Speed>Mb"</i>	It means to set bandwidth utilization setting. <WAN number>: Enter the index number of WAN interface(s). <Medium threthold>: Enter a value. <High threthold>: Enter a value. <TX Speed>Mb: Enter a value. <RX Speed>Mb: Enter a value.
<i>-S</i>	Show the CPE notification settings.

Example

```
> sys tr069 get InternetGatewayDevice.ManagementServer.
Total number of parameter is 98
Total content length of parameter is 6473

InternetGatewayDevice.ManagementServer.URL= http://192.168.100.10:8080/ACSServlet
InternetGatewayDevice.ManagementServer.Username= fae
InternetGatewayDevice.ManagementServer.Password=
InternetGatewayDevice.ManagementServer.PeriodicInformEnable= 0
InternetGatewayDevice.ManagementServer.PeriodicInformInterval= 900
InternetGatewayDevice.ManagementServer.PeriodicInformTime= 1970-01-01T00:00:00
InternetGatewayDevice.ManagementServer.ParameterKey=
InternetGatewayDevice.ManagementServer.ConnectionRequestURL= http://192.168.100.
1:8069/cwm/CRN.html
InternetGatewayDevice.ManagementServer.ConnectionRequestUsername= vigor
InternetGatewayDevice.ManagementServer.ConnectionRequestPassword=
InternetGatewayDevice.ManagementServer.UpgradesManaged= 0
InternetGatewayDevice.ManagementServer.UDPConnectionRequestAddress= 111.251.214.
196:38518
InternetGatewayDevice.ManagementServer.UDPConnectionRequestAddressNotification-L
imit= 0
InternetGatewayDevice.ManagementServer.STUNEnable= 0
InternetGatewayDevice.ManagementServer.STUNServerAddress=
InternetGatewayDevice.ManagementServer.STUNServerPort= 3478
InternetGatewayDevice.ManagementServer.STUNUsername=
InternetGatewayDevice.ManagementServer.STUNPassword=
InternetGatewayDevice.ManagementServer.STUNMaximumKeepAlivePeriod= -1
InternetGatewayDevice.ManagementServer.STUNMinimumKeepAlivePeriod= 60
InternetGatewayDevice.ManagementServer.NATDetected= 0
InternetGatewayDevice.ManagementServer.ManageableDeviceNumberOfEntries= 0
InternetGatewayDevice.ManagementServer.CPEEnable= 1
InternetGatewayDevice.ManagementServer.ApplyApEnable= 0
InternetGatewayDevice.ManagementServer.ApplyApPassword=
InternetGatewayDevice.ManagementServer.BWUNEnable= 1
InternetGatewayDevice.ManagementServer.BWUNPeriodic= 3
InternetGatewayDevice.ManagementServer.BWUNWANNNumberOfEntries= 12
InternetGatewayDevice.ManagementServer.BWUNWAN.1.Enable= 0
InternetGatewayDevice.ManagementServer.BWUNWAN.1.Medium= 0
InternetGatewayDevice.ManagementServer.BWUNWAN.1.High= 0
InternetGatewayDevice.ManagementServer.BWUNWAN.1.TX= 0
InternetGatewayDevice.ManagementServer.BWUNWAN.1.RX= 0
InternetGatewayDevice.ManagementServer.BWUNWAN.2.Enable= 0
InternetGatewayDevice.ManagementServer.BWUNWAN.2.Medium= 0
InternetGatewayDevice.ManagementServer.BWUNWAN.2.High= 0
InternetGatewayDevice.ManagementServer.BWUNWAN.2.TX= 0
InternetGatewayDevice.ManagementServer.BWUNWAN.2.RX= 0
InternetGatewayDevice.ManagementServer.BWUNWAN.3.Enable= 0
```



```
InternetGatewayDevice.ManagementServer.BWUNWAN.3.Medium= 0
InternetGatewayDevice.ManagementServer.BWUNWAN.3.High= 0
InternetGatewayDevice.ManagementServer.BWUNWAN.3.TX= 0
InternetGatewayDevice.ManagementServer.BWUNWAN.3.RX= 0
InternetGatewayDevice.ManagementServer.BWUNWAN.4.Enable= 0
InternetGatewayDevice.ManagementServer.BWUNWAN.4.Medium= 0
InternetGatewayDevice.ManagementServer.BWUNWAN.4.High= 0
InternetGatewayDevice.ManagementServer.BWUNWAN.4.TX= 0
InternetGatewayDevice.ManagementServer.BWUNWAN.4.RX= 0
InternetGatewayDevice.ManagementServer.BWUNWAN.5.Enable= 0
InternetGatewayDevice.ManagementServer.BWUNWAN.5.Medium= 0
InternetGatewayDevice.ManagementServer.BWUNWAN.5.High= 0
InternetGatewayDevice.ManagementServer.BWUNWAN.5.TX= 0
InternetGatewayDevice.ManagementServer.BWUNWAN.5.RX= 0
InternetGatewayDevice.ManagementServer.BWUNWAN.6.Enable= 0
InternetGatewayDevice.ManagementServer.BWUNWAN.6.Medium= 0
InternetGatewayDevice.ManagementServer.BWUNWAN.6.High= 0
InternetGatewayDevice.ManagementServer.BWUNWAN.6.TX= 0
InternetGatewayDevice.ManagementServer.BWUNWAN.6.RX= 0
InternetGatewayDevice.ManagementServer.BWUNWAN.7.Enable= 0
InternetGatewayDevice.ManagementServer.BWUNWAN.7.Medium= 0
InternetGatewayDevice.ManagementServer.BWUNWAN.7.High= 0
InternetGatewayDevice.ManagementServer.BWUNWAN.7.TX= 0
InternetGatewayDevice.ManagementServer.BWUNWAN.7.RX= 0
InternetGatewayDevice.ManagementServer.BWUNWAN.8.Enable= 0
InternetGatewayDevice.ManagementServer.BWUNWAN.8.Medium= 0
InternetGatewayDevice.ManagementServer.BWUNWAN.8.High= 0
InternetGatewayDevice.ManagementServer.BWUNWAN.8.TX= 0
InternetGatewayDevice.ManagementServer.BWUNWAN.8.RX= 0
InternetGatewayDevice.ManagementServer.BWUNWAN.9.Enable= 0
InternetGatewayDevice.ManagementServer.BWUNWAN.9.Medium= 0
InternetGatewayDevice.ManagementServer.BWUNWAN.9.High= 0
InternetGatewayDevice.ManagementServer.BWUNWAN.9.TX= 0
InternetGatewayDevice.ManagementServer.BWUNWAN.9.RX= 0
InternetGatewayDevice.ManagementServer.BWUNWAN.10.Enable= 0
InternetGatewayDevice.ManagementServer.BWUNWAN.10.Medium= 0
InternetGatewayDevice.ManagementServer.BWUNWAN.10.High= 0
InternetGatewayDevice.ManagementServer.BWUNWAN.10.TX= 0
InternetGatewayDevice.ManagementServer.BWUNWAN.10.RX= 0
InternetGatewayDevice.ManagementServer.BWUNWAN.11.Enable= 0
InternetGatewayDevice.ManagementServer.BWUNWAN.11.Medium= 0
InternetGatewayDevice.ManagementServer.BWUNWAN.11.High= 0
InternetGatewayDevice.ManagementServer.BWUNWAN.11.TX= 0
InternetGatewayDevice.ManagementServer.BWUNWAN.11.RX= 0
InternetGatewayDevice.ManagementServer.BWUNWAN.12.Enable= 0
InternetGatewayDevice.ManagementServer.BWUNWAN.12.Medium= 0
InternetGatewayDevice.ManagementServer.BWUNWAN.12.High= 0
InternetGatewayDevice.ManagementServer.BWUNWAN.12.TX= 0
InternetGatewayDevice.ManagementServer.BWUNWAN.12.RX= 0
InternetGatewayDevice.ManagementServer.HttpsTriggerEnable= 0
InternetGatewayDevice.ManagementServer.ApplyApSTUNEnable= 0
InternetGatewayDevice.ManagementServer.ApSTUNEnable= 0
InternetGatewayDevice.ManagementServer.ApSTUNServerAddress=
InternetGatewayDevice.ManagementServer.ApSTUNServerPort= 3478
InternetGatewayDevice.ManagementServer.ApSTUNMaximumKeepAlivePeriod= -1
InternetGatewayDevice.ManagementServer.ApSTUNMinimumKeepAlivePeriod= 60
InternetGatewayDevice.ManagementServer.AcquireURLEnable= 0
InternetGatewayDevice.ManagementServer.CPEPort= 8069
InternetGatewayDevice.ManagementServer.CPEClear=
```

Telnet Command: sys health

This command can turn on/off SIP ALG (Application Layer Gateway) for traversal.

Syntax

```
sys health cpu_usage
sys health mem_usage
sys health arp_status
sys health dos_status
sys health sess_usage
sys health view
sys health vpn_status
sys health voip_status
```

Syntax Description

Parameter	Description
<i><command><parameter></i>	The available commands with parameters are listed below.
<i>cpu_usage</i> <i><command><parameter></i>	-E <1/0> : Enable/disable this health parameter settings-CPU usage. -w <threshold> : Sets the warning threshold, 0-100 percent. -e <threshold> : Sets the emergency threshold, 0-100 percent. -r <interval> : Sets the warning report interval, 1-1440 min. -m <interval> : Sets the emergency report interval, 1-1440 min.
<i>mem_usage</i> <i><command><parameter></i>	- E <1/0> : Enable/disable this health parameter settings-memory usage. -w <threshold> : Sets the warning threshold, 0-100 percent. -e <threshold> : Sets the emergency threshold, 0-100 percent. -r <interval> : Sets the warning report interval, 1-1440 min. -m <interval> : Sets the emergency report interval, 1-1440 min.
<i>arp_status</i> <i><command><parameter></i>	-E <1/0> : Enable/disable this health parameter settings-ARP status. -w <threshold> : Warning threshold, 0-100 percent. -e <threshold> : Emergency threshold, 0-100 percent. -r <interval>: Warning report interval, 1-1440 min. -m <interval>: Emergency report interval, 1-1440 min.
<i>dos_status</i> <i><command><parameter></i>	-E <1/0>: Enable / disable this health parameter settings-DoS status. -r <interval>: Warning report interval, 1-1440 min. -m <interval>: Emergency report interval, 1-1440 min.
<i>sess_usage</i> <i><command><parameter></i>	-E <1/0>: Enable/disable this health parameter setting-session usage. -w <threshold> : Warning threshold, 0-100 percent. -e <threshold> : Emergency threshold, 0-100 percent. -r <interval>: Warning report interval, 1-1440 min. -m <interval>: Emergency report interval, 1-1440 min.
<i>View</i>	Displays current settings for health parameters.
<i>vpn_status</i> <i><command><parameter></i>	-E <1/0>: Enable/disable this health parameter setting-VPN status. -w <threshold> : Warning threshold, 0-100 percent. -e <threshold> : Emergency threshold, 0-100 percent.

	-r <interval>: Warning report interval, 1-1440 min. -m <interval>: Emergency report interval, 1-1440 min
<i>voip_status</i> <command><parameter>	-E <1/0> : Enable/disable this health parameter setting-VoIP status. -w <threshold> : Warning threshold, 0-100 percent. -e <threshold> : Emergency threshold, 0-100 percent. -r <interval> : Warning report interval, 1-1440 min. -m <interval> : Emergency report interval, 1-1440 min.

Example

```

> sys health vpn_status -m 30
% Set emergency interval to 30 min.
> sys health view
%
%
% -----
% [ ] CPU Status                Threshold:   90      95
%                               Report Interval: 5        2
% -----
% [ ] Memory Status             Threshold:   88      95
%                               Report Interval: 5        2
% -----
% [ ] ARP Status                Threshold:   60      80
%                               Report Interval: 15       5
% -----
% [ ] Session Usage             Threshold:   60      80
%                               Report Interval: 15       5
% -----
% [ ] DDoS Status               Report Interval: 5        1
% -----
% [ ] VPN Status                Report Interval: 0        30
% -----
% [ ] VoIP R-Factor            Threshold:   60      40
%                               Report Interval: 1        1
%

```

Telnet Command: sys alg

This command can enable /disable the ALG (Application Layer Gateway) function.

Syntax

sys alg -e <0/1>

Example

```

> sys alg -e 1
Enable ALG
>

```

Telnet Command: sys sip_alg

This command can turn on/off SIP ALG (Application Layer Gateway) for traversal.

Syntax

sys sip_alg <command> <parameter>

Syntax Description

Parameter	Description
<i>[<command> <parameter>/...]</i>	The available commands with parameters are listed below. <i>[...]</i> means that you can type in several commands in one line.
<i>-e <0/1></i>	0: Disable the function of SIP ALG. 1: Enable the function of SIP ALG.
<i>-p <parameter></i>	It means to set the listening port for SIP ALG. <parameter> : Ranges from 1 to 65535.
<i>-u <0/1></i>	It means to enable or disable the listen along UDP path setting. 0: Disable 1: Enable
<i>-t <0/1></i>	It means to enable or disable the listen along TCP path setting. 0: Disable 1: Enable

Example

```

> sys sip_alg -e 1
  Auto enable ALG Master Switch
  Enable SIP ALG
> sys sip_alg -p 65535
  Current listening port: 65535
> sys sip_alg ?
Usage: sys sip_alg <command> <parameter>
  -e: enable SIP ALG (0:disable, 1:enable)
  -p: set your listening port for SIP ALG
  -u: enable listen along UDP path (0:disable, 1:enable)
  -t: enable listen along TCP path (0:disable, 1:enable)

Current SIP ALG status
  -ALG Master Switch: Enabled
  -SIP ALG: Enabled
  -Listen along UDP path: Yes
  -Listen along TCP path: Yes
  -Listening Port: 65535
  -Max sipalg session num: 512
  -Remain sipalg session num: 512
>

```

Telnet Command: sys rtsp_alg

This command can turn on/off RTSP (Real Time Streaming Protocol) ALG (Application Layer Gateway) for traversal.

Syntax

sys rtsp_alg <command> <parameter>

Syntax Description

Parameter	Description
<command> <parameter>	-e <1/0>: Enable or disable (0:disable, 1:enable) the function of RTSP ALG. -p <1 to 65535>: set your listening port for RTSP ALG. -u <1/0>: Enable or disable (0:disable, 1:enable) the listen along UDP path. -t <1/0>: Enable or disable (0:disable, 1:enable) the listen along TCP path . -v: show RTP and RTCP portmap information of RTSP ALG.
-e <0/1>	0: Disable the function of RTSP ALG. 1: Enable the function of RTSP ALG.
-p <parameter>	It means to set the listening port for RTSP ALG. <parameter> : Ranges from 1 to 65535.
-u <0/1>	It means to enable or disable the listen along UDP path setting. 0: Disable 1: Enable
-t <0/1>	It means to enable or disable the listen along TCP path setting. 0: Disable 1: Enable
-v	It displays RTP and RTCP portmap information of RTSP ALG.

Example

```
> sys rtsp_alg -p 333
Current listening RTSP Port: 333
> sys rtsp_alg -v
Current Open PortMap Number of RTSP ALG: 0
```

Telnet Command: sys license

This command can process the system license.

Syntax

sys license *reset_regser*

sys license *licera*

```

sys license licifno <AUTO/WAN#>
sys license licalias <index>
sys license lic_trigger
sys license liclog

```

Syntax Description

Parameter	Description
<i>reset_regser</i>	It means the license register server setting.
<i>licera</i>	It means to erase license setting.
<i>Licifno</i> <AUTO/WAN#>	It means to license and signature download (authenticated with MyVigor) interface setting.
<i>licalias</i> <index>	It means to license and signature download WAN Alias IP setting(also affect WCF).
<i>lic_trigger</i>	It means to automatically trigger the license to update on boot time.
<i>liclog</i>	Displays authentication log.

Example

```

> sys license licifno

License and Signature download interface setting:
licifno [AUTO/WAN#]

Ex: licifno wan1

Download interface is "auto-selected" now.

```

Telnet Command: sys fr_log

This command is used for displaying log information related to web syslog.

Syntax

```
sys fr_log
```

Example

```

> sys fr_log ?

-----

Note: This command shows the same log information with
Diagnostics>>Syslog Explorer. If you don't see any log information,
go to the Web Interface and make sure Diagnostics>>Syslog Explorer is
enabled.

```

Telnet Command: sys arp_AutoReq

This command is used to enable / disable the function that Vigor router sends ARP request to the connected device(s) periodically.

Syntax

sys arp_AutoReq -d <value>

Syntax Description

Parameter	Description
-d <value>	Disable the function of ARP auto request. 0 - Enable 1 - Disable

Example

```
> sys arp_AutoReq -d 0
Arp auto-request enable.
```

Telnet Command: sys daylightsave

This command is used to configure daylight save setting.

Syntax

sys daylightsave [-<command> <parameter> | ...]

Syntax Description

Parameter	Description
[<command><parameter> ...]	The available commands with parameters are listed below. [...] means that you can type in several commands in one line.
-v	Display the daylight saving settings.
-r	Set to factory default setting.
-e <1/0>	Enable (1) / disable (0) daylight saving.
-t <0/1/2>	Specify the saving type for daylight setting. 0 - Default 1 - Time range 2 - Yearly
-s <year> <month> <day> <hour>	Set the detailed settings of the starting day for time range type. year - must be the year after 2013. month - 1 ~ 12 day - 1 ~ 31 hour - 0 ~ 23 e.g., sys daylightsave -s 2014 3 10 12
-d <year> <month> <day> <hour>	Set the detailed settings of the ending day for time range type. year - After 2013. month - 1 ~ 12 day - 1 ~ 31 hour - 0 ~ 23 e.g., sys daylightsave -d 2014 9 10 12
-y <month> <th weekday> <day in week> <hour>	Set the detailed settings of the starting day for yearly type. month - 1 ~ 12 th weekday - 1 ~ 5, 9: last week day in week - 0:Sun, 1:Mon, 2:Tue, 3:Wed, 4:Thu, 5: Fri, 6:Sat hour - 0 ~ 23 e.g., sys daylightsave -y 9 1 0 14

<pre>-z <month> <th weekday> <day in week> <hour></pre>	<p>Set the detailed settings of the ending day for yearly type.</p> <p>month - 1 ~ 12</p> <p>th weekday - 1 ~ 5, 9: last week</p> <p>day in week - 0:Sun, 1:Mon, 2:Tue, 3:Wed, 4:Thu, 5: Fri, 6:Sat</p> <p>hour - 0 ~ 23</p> <p>e.g, sys daylightsave -z 3 1 6 14</p>
---	---

Example

```
> sys daylightsave -y 9 1 0 14
% Start: Yearly on Sep 1th Sun 14:00
```

Telnet Command: sys dnsCacheTbl

This command is used to configure TTL settings which will be displayed in DNS Cache table.

Syntax

```
sys dnsCacheTbl [<command><parameter>|...]
```

Syntax Description

Parameter	Description
<i>[<command><parameter> ...]</i>	The available commands with parameters are listed below. <i>[...]</i> means that you can type in several commands in one line.
-l	Display DNS IPv4 entry in the DNS cache table.
-s	Display DNS IPv6 entry in the DNS cache table.
-v	Display the TTL limit value in the DNS cache table.
-t <0/n >	Set the TTL limit value in the DNS cache table. 0 - No limit N - Greater than or equal to 5.
-c	Clear the DNS cache table.

Example

```
> sys dnsCacheTbl -l
%DNS Cache Table List
swm.draytek.com 192.168.18.18      601454 Black List
relay-20c8ac21.net.anydesk.com 84.17.34.77      11530 Black List
auth.draytek.com 35.189.201.134      602322 Black List
www.draytek.com 104.25.10.249      601712 Black List
ms.draytek.com 172.16.2.8      601448 Black List
>
```

Telnet Command: sys syslog

This command is used to configure

Syntax

```
sys syslog -a <enable> [-<command> <parameter> | ... ]
```

Syntax Description

Parameter	Description
<i>[<command><parameter>/...]</i>	The available commands with parameters are listed below. [...] means that you can type in several commands in one line.
<i>-a <1/0></i>	Enable (1) or disable (0) Syslog Access Setup.
<i>-s <1/0></i>	Enable (1) or disable (0) Syslog Save to Syslog Server.
<i>-i <IP address></i>	Define the IP address of the Syslog server.
<i>-d <port number></i>	Define the port number (1 ~ 65535) as the destination port.
<i>-I <IP address></i>	Define the IP address for the Secondary Server.
<i>-D <port number></i>	Define the Destination Port (1 ~ 65535) for the Secondary Server.
<i>-u <1/0></i>	Enable (1) or disable (0) Syslog Save to USB Disk.
<i>-m <1/0></i>	Enable (1) or disable (0) Mail Syslog.
<i>-f <1/0></i>	Enable (1) or disable (0) Firewall Log.
<i>-v <1/0></i>	Enable (1) or disable (0) VPN Log.
<i>-e <1/0></i>	Enable (1) or disable (0) User Access Log.
<i>-c <1/0></i>	Enable (1) or disable (0) Call Log.
<i>-w <1/0></i>	Enable (1) or disable (0) WAN Log.
<i>-l <1/0></i>	Enable (1) or disable (0) WLAN Log
<i>-r <1/0></i>	Enable (1) or disable (0) Router/DSL Information.
<i>-P</i>	Update the server IP address.
<i>-W <1/0></i>	Set the write syslog mode. 1 - Stop logging. 0 - Overwrite the oldest logs.
<i>-U <1/0></i>	Set the unit for saving the Syslog to the USB disk. 1 - MB. 0 - GB.
<i>-S <capacity></i>	Set the folder capacity for the Syslog in the USB disk. 1-16GB or 1-1024MB

Example

```
> sys syslog -a 1 -s 1 -i 192.168.1.25 -d 514
>
```

Telnet Command: sys mailalert

This command is used to configure settings for syslog mail alert.

Syntax

`sys mailalert [-<command> <parameter>]`

Syntax Description

Parameter	Description
<i>[<command><parameter>]</i>	The available commands with parameters are listed below.
<i>-e <0/1></i>	Enable/disable Mail Alert.

	0 - Disable. 1 - Enable.
-w <0/1/2/...>	Set an interface (physically). <0/1/2/...> - 0 means Any; 1 means WAN1; 2 means WAN2; and so no.
-x <WAN IP Alias index>	Set the WAN IP Alias. In which, index #1 is reserved and must be set with an interface first.
-i <SMTP Server IP>	Set IP Address for SMTP server.
-o <SMTP Server Port>	Set port number for SMTP server..
-a <Mail Address>	Set E-mail address for alert mail reciver.
-r <Mail Address>	Set E-mail Address for mail return.
-s <0/1/2/3>	Set the connection security for SSL. 0 : Plaintext. 1: SSL. 2: StartTLS. 3: Force StartTLS.
-h<0/1>	Enable/disable SMTP Authentication. 0 - Disable. 1 - Enable.
-u <Username>	Set username for SMTP Authentication.
-p <Password>	Set password for SMTP Authentication.
-l <type><0/1>	Enable / disable mail alert for different types. Number 0 ~ 6 represent different types. "0 <0/1>" : Enable/Disable Mail Alert of the DoS Attack. "1 <0/1>" : Enable/Disable Mail Alert of the APPE. "2 <0/1>" : nable/Disable Mail Alert of the VPN Log. "6 <0/1>" : Enable/Disable Mail Alert of the Reboot Debug Log. In which, 0 - Disable. 1 - Enable.
-f	Reset Mail Alert setting to factory default.
-v	Show current Mail Alert setting.
-R <0/1>	Set Mail Alert Reboot debug log mode. 0: Limited Mode 1: Unlimited Mode.

Example

```

> sys mailalert -e 1
Set Enable Mail Alert.
> sys mailalert -v
----- Current setting for Mail Alert -----
Mail Alert: Enable
SMTP Server IP Address: 255.255.255.255
SMTP Server Port: 25
Alert Mail Reciver E-mail Address:
Mail Return E-mail Address:
Use SSL: Disable
SMTP Authentication: Disable
Username for SMTP Authentication:
Password for SMTP Authentication:
Mail Alert for DoS Attack: Enable.
Mail Alert for APPE: Enable.
Mail Alert for VPN Log: Enable.
Mail Alert for Reboot Debug Log: Disable, Mode: Limited.
-----

```

Telnet Command: sys time

This command is used to configure system time and date.

Syntax

`sys time server <domain>`

`sys time inquire`

`sys time show`

`sys time wan <option>`

`sys time zone <index>`

`sys time pseudo`

Syntax Description

Parameter	Description
<code>server <domain></code>	Enter the domain name of the time server. <domain> - The maximum length is 39 characters.
<code>inquire</code>	Get the time based on the timer server setting.
<code>show</code>	Displays current server setting.
<code>wan <option></code>	0 - Auto 1 - WAN1 2 - WAN2 3 - WAN3 4 - WAN4 5 - WAN5 6 - WAN6 ... 12 - WAN12 If you want to select WAN Alias IP, the value of Send NTP Request Through shouldn't be Auto.
<code>zone <index></code>	Different number means different time zone. 1 - GMT-12:00 Eniwetok, Kwajalein 2 - GMT-11:00 Midway Island, Samoa 3 - GMT-10:00 Hawaii 4 - GMT-09:00 Alaska 5 - GMT-08:00 Pacific Time (US & Canada) 6 - GMT-08:00 Tijuana 7 - GMT-07:00 Mountain Time (US & Canada) 8 - GMT-07:00 Arizona 9 - GMT-06:00 Central Time (US & Canada) 10 - GMT-06:00 Saskatchewan 11 - GMT-06:00 Mexico City, Tegucigalpa 12 - GMT-05:00 Eastern Time (US & Canada) 13 - GMT-05:00 Indiana (East) 14 - GMT-05:00 Bogota, Lima, Quito 15 - GMT-04:00 Atlantic Time (Canada) 16 - GMT-04:00 Caracas, La Paz 17 - GMT-04:00 Santiago 18 - GMT-03:30 Newfoundland 19 - GMT-03:00 Brasilia 20 - GMT-03:00 Buenos Aires, Georgetown 21 - GMT-02:00 Mid-Atlantic 22 - GMT-01:00 Azores, Cape Verde Is. 23 - GMT Greenwich Mean Time : Dublin 24 - GMT Edinburgh, Lisbon, London 25 - GMT Casablanca, Monrovia

	26 - GMT+01:00 Belgrade, Bratislava 27 - GMT+01:00 Budapest, Ljubljana, Prague 28 - GMT+01:00 Sarajevo, Skopje, Sofija 29 - GMT+01:00 Warsaw, Zagreb 30 - GMT+01:00 Brussels, Copenhagen 31 - GMT+01:00 Madrid, Paris, Vilnius 32 - GMT+01:00 Amsterdam, Berlin, Bern 33 - GMT+01:00 Rome, Stockholm, Vienna 34 - GMT+02:00 Bucharest 35 - GMT+02:00 Cairo 36 - GMT+02:00 Helsinki, Riga, Tallinn 37 - GMT+02:00 Athens, Istanbul, Minsk 38 - GMT+02:00 Jerusalem 39 - GMT+02:00 Harare, Pretoria 40 - GMT+03:00 Volgograd 41 - GMT+03:00 Baghdad, Kuwait, Riyadh 42 - GMT+03:00 Nairobi 43 - GMT+03:00 Moscow, St. Petersburg 44 - GMT+03:30 Tehran 45 - GMT+04:00 Abu Dhabi, Muscat 46 - GMT+04:00 Baku, Tbilisi 47 - GMT+04:30 Kabul 48 - GMT+05:00 Ekaterinburg 49 - GMT+05:00 Islamabad, Karachi, Tashkent 50 - GMT+05:30 Bombay, Calcutta 51 - GMT+05:30 Madras, New Delhi 52 - GMT+06:00 Astana, Almaty, Dhaka 53 - GMT+06:00 Colombo 54 - GMT+07:00 Bangkok, Hanoi, Jakarta 55 - GMT+08:00 Beijing, Chongqing 56 - GMT+08:00 Hong Kong, Urumqi 57 - GMT+08:00 Singapore 58 - GMT+08:00 Taipei 59 - GMT+08:00 Perth 60 - GMT+09:00 Seoul 61 - GMT+09:00 Osaka, Sapporo, Tokyo 62 - GMT+09:00 Yakutsk 63 - GMT+09:30 Darwin 64 - GMT+09:30 Adelaide 65 - GMT+10:00 Canberra, Melbourne, Sydney 66 - GMT+10:00 Brisbane 67 - GMT+10:00 Hobart 68 - GMT+10:00 Vladivostok 69 - GMT+10:00 Guam, Port Moresby 70 - GMT+11:00 Magadan, Solomon Is. 71 - GMT+11:00 New Caledonia 72 - GMT+12:00 Fiji, Kamchatka, Marshall Is. 73 - GMT+12:00 Auckland, Wellington
<i>pseudo -E <1/0></i>	Enable (1) or disable (0) the pseudo system time.
<i>pseudo -T <year> <month> <day> <hour> <minute></i>	Set the pseudo time value. <year> - Enter four digits. <month> - Enter 1 to 12. <day> - Enter the day in a month. <hour> - Enter the number of the hour (1 to 23). <minute> - Enter the number of the minute (1 to 59).
<i>pseudo -S</i>	Displays pseudo system time.

Example

```

> sys time zone 8
Set Time Zone OK

> sys time show
***** System Time *****

```

```

Current System Time: [2000 Jan 01 Sat 02:09:29]
Time Server: [pool.ntp.org]
Time Zone Index: [8]. GMT-07:00
*****

```

Telnet Command: `sys eap_tls`

This command is used to disable or enable EAP-TLS.

You might have to enable EAP-TLS compatibility to avoid compatibility issues with some operating systems. But, please note that enabling EAP-TLS compatibility will lower down the connection security level.

Syntax

```
sys eap_tls set <0/1>
```

Syntax Description

Parameter	Description
0	Disable EAP-TLS compatibility!
1	Enable EAP-TLS compatibility!

Example

```

> sys eap_tls set 1
Enable EAP_TLS compatibility!

```

Telnet Command: `sys dashboard`

This command is used to display / hide items (such as System Information, Interface...) on dashboard.

Syntax

```
sys dashboard [-<command> <value> | ... ]
```

```
sys dashboard show
```

Syntax Description

Parameter	Description
<code>[<command> <value> ...]</code>	<p>The available commands with parameters are listed below. <code>[...]</code> means that you can type in several parameters in one line. <code><command></code> "0 ~ 9" and "a" represent different sections to be displayed on the dashboard.</p> <ul style="list-style-type: none"> 0 : Front Panel 1 : System Information 2 : IPv4 LAN Information 3 : IPv4 Internet Access 4 : IPv6 Internet Access 5 : Interface 6 : Security 7 : System Resource 8 : LTE Status 9 : Quick Access a : VoIP <p><code><value></code> 1 : Enable</p>

	0 : Disable
<i>show</i>	Display current status (enabled /disabled) for each item.

Example

```
> sys dashboard -0 1
Front Panel enabled
> sys dashboard show
Front Panel enabled
System Information enabled
IPv4 LAN Information enabled
IPv4 Internet Access enabled
IPv6 Internet Access enabled
Interface enabled
Security enabled
System Resource enabled
LTE Status enabled
Quick Access enabled
VoIP enabled
```

Telnet Command: sys max_session

This command is used to set the maximum sessions.

Syntax

sys max_session <300K/500K/1000K>

Syntax Description

Parameter	Description
<300K/500K/1000K>	At present, there are four values available for selection.

Example

```
> sys max_session 300K
Please reboot to apply settings of MAX sessions : 300K
```

Telnet Command: sys webhook

This command is used to send a report (webhook message) including WAN up, down, CPU usage, memory usage and etc. to a monitoring server periodically.

Syntax

```
sys webhook enable <val>
sys webhook send
sys webhook status
sys webhook url <server_url>
sys webhook period <val>
```

Syntax Description

Parameter	Description
<i>send</i>	Triggers the webhook report immediately.
<i>status</i>	Displays the webhook current setting.

<i>enable</i> <val>	Enable or disable the function of webhook. <val> 1 : Enable 0 : Disable
<i>url</i> <server_url>	Set the URL of the webhook server.
<i>period</i> <val>	Set the report period (1 to 1440 minutes).

Example

```
> sys webhook status
webhook is off
Monitoring Server URL:
Report Period: 3
```

Telnet Command: testmail

This command is used to display current settings for sending test mail.

Example

```
> testmail
Send out test mail
Mail Alert:[Enable]
Interface :Any
WAN_Alias index:[0]
SMTP_Server:[255.255.255.255]
SMTP_Port:[25]
Mail to:[]
Return-Path:[]
Connection Security:[Plaintext]
```

Telnet Command: upnp off

This command can close UPnP function.

Example

```
>upnp off
UPNP say bye-bye
```

Telnet Command: upnp on

This command can enable UPnP function.

Example

```
>upnp on
UPNP start.
```

Telnet Command: upnp nat

This command can display IGD NAT status.

Example

```
> upnp nat ?
***** IGD NAT Status *****

((0))
InternalClient >>192.168.1.10<<, RemoteHost >>0.0.0.0<<
InternalPort >>21<<, ExternalPort >>21<<
PortMapProtocol >>TCP<<
The tmpvirtual server index >>0<<
PortMapLeaseDuration >>0<<, PortMapEnabled >>0<<
Ftp Example [MICROSOFT]
((1))
InternalClient >>0.0.0.0<<, RemoteHost >>0.0.0.0<<
InternalPort >>0<<, ExternalPort >>0<<
PortMapProtocol >><NULL><<
The tmpvirtual server index >>0<<
PortMapLeaseDuration >>0<<, PortMapEnabled >>0<<
PortMapProtocol >><NULL><<
The tmpvirtual server index >>0<<
PortMapLeaseDuration >>0<<, PortMapEnabled >>0<<
0<<

--- MORE ---  ['q': Quit, 'Enter': New Lines, 'Space Bar': Next Page] ---
```

Telnet Command: upnp service

This command can display the information of the UPnP service. UPnP service must be enabled first.

Example

```
> upnp on
UPNP start.

> upnp service
>>>> SERVICE TABLE1 <<<<<
  serviceType urn:schemas-microsoft-com:service:OSInfo:1
  serviceId   urn:microsoft-com:serviceId:OSInfo1
  SCPDURL     /upnp/OSInfo.xml
  controlURL  /OSInfo1
  eventURL    /OSInfoEvent1
  UDN         uuid:774e9bbe-7386-4128-b627-001daa843464

>>>> SERVICE TABLE2 <<<<<
  serviceType
urn:schemas-upnp-org:service:WANCommonInterfaceConfig:1
  serviceId   urn:upnp-org:serviceId:WANCommonIFC1
  SCPDURL     /upnp/WComIFCX.xml
  controlURL  /upnp?control=WANCommonIFC1
  eventURL    /upnp?event=WANCommonIFC1
  UDN         uuid:2608d902-03e2-46a5-9968-4a54ca499148
```



```
.  
. .  
. .
```

Telnet Command: upnp subscribe

This command can show all UPnP services subscribed.

Example

```
> upnp on  
UPNP start.  
> upnp subscribe  
>>>> (1) serviceType urn:schemas-microsoft-com:service:OSInfo:1  
  
----- Subscribtion1 -----  
  
sid = 7a2bbdd0-0047-4fc8-b870-4597b34da7fb  
  
eventKey =1, ToSendEventKey = 1  
  
expireTime =6926  
  
active =1  
  
DeliveryURLs  
=<http://192.168.1.113:2869/upnp/eventing/twtnpnsiun>  
  
>>>> (2) serviceType  
urn:schemas-upnp-org:service:WANCommonInterfaceConfig:1  
  
----- Subscribtion1 -----  
  
sid = d9cd47a5-d9c9-4d3d-8043-d03a82f27983  
  
eventKey =1, ToSendEventKey = 1  
  
. .  
. .
```

Telnet Command: upnp tmpvs

This command can display current status of temp Virtual Server of your router.

Example

```
> upnp tmpvs  
***** Temp virtual server status *****  
  
((0))  
real_addr >>192.168.1.10<<, pseudo_addr >>172.16.3.229<<  
real_port >>0<<, pseudo_port >>0<<  
hit_portmap_index >>0<<  
The protocol >>TCP<<  
time >>0<<
```

```

((1))
real_addr >>0.0.0.0<<, pseudo_addr >>0.0.0.0<<
real_port >>0<<, pseudo_port >>0<<
hit_portmap_index >>0<<
The protocol >>0<<
time >>0<<
--- MORE ---  ['q': Quit, 'Enter': New Lines, 'Space Bar': Next Page]
---
```

Telnet Command: upnp wan

This command is used to specify WAN interface to apply UPnP.

Syntax

```
upnp wan <n>
```

Syntax Description

Parameter	Description
<i>n</i>	It means to specify WAN interface (0 to 12) to apply UPnP. n=0, it means to auto-select WAN interface. n=1, WAN1 n=2, WAN2

Example

```
> upnp wan 1
use wan1 now.
```

Telnet Command: usb devstat

This command is use to display if there is nay USB devices connecting to Vigor router.

Example

```
> usb devstat ?
USB Port1: No device
USB Port2: No device
>
```

Telnet Command: usb user

This command is used to set profiles for FTP/SMB users.

Syntax Description

```
usb user add <Index> <Username> <Password> <Permission> <Home path>
```

```
usb user rm <Index>
```

```
usb user enable <Index>
```

```
usb user disable <Index>
```

```
usb user list
```

Syntax Description

Parameter	Description
<i>add</i> <Index> <Username> <Password> <Permission> <Home path>	Add a new user profile. <Index> - It means the index number of the user profile. There are 16 profiles allowed to be configured. So the range of such option is 1 ~ 16. <Username> - Type a text (maximum 131 characters) as the username for the user profile. <Password> - Type a text (maximum 131 characters) as the password for the user profile. <Permission> - Specify the action (RWDLCR) permitted. If one of the actions is not allowed, simple type "-" instead. R - Read File. W - Write File. D - Delete File. L - List directory. C - Create directory. R - Remove selected directory. <Home path> - Set the path (maximum 159 characters) for the USB user profile.
<i>rm</i> <Index>	Delete an existed user profile. <Index> - It means the index number of the user profile. There are 16 profiles allowed to be configured. So the range of such option is 1 ~ 16.
<i>enable</i> <Index>	Enable a user profile. <Index> - It means the index number of the user profile. There are 16 profiles allowed to be configured. So the range of such option is 1 ~ 16.
<i>disable</i> <Index>	Disable a user profile. <Index> - It means the index number of the user profile. There are 16 profiles allowed to be configured. So the range of such option is 1 ~ 16.
<i>list</i>	Display all of the user profile.

Example

```
> usb user add 1 root 1234 R-DLCR /usr
>
```

Telnet Command: usb temp

This command is to configure USB temperature.

Syntax Description

```
usb temp set <c/-f/-a/-b/-m/-u/-l/-r>
```

```
usb temp show
```

```
usb temp all_data
```

Syntax Description

Parameter	Description
<i>set -c</i>	Set the temperature unit (Celsius).

<i>set -f</i>	Set the temperature unit (Fahrenheit).
<i>set -a</i>	Set the temperature sensor by using a probe or the built-in sensor automatically. The probe will be detected and used first, and fall back to the built-in sensor if the probe is not detected.
<i>set -b</i>	Set to use the built-in sensor.
<i>set -m <0/1></i>	Enable or disable the Alarm Setting. 1: Enable 0: Disable
<i>set -u <value></i>	Set the upper temperature limit. <value>: Enter a value, e.g., 30.35.
<i>set -l <value></i>	Set the lower temperature limit. <value>: Enter a value, e.g., 10.35.
<i>set -r</i>	Shows the setting of temperature unit and sensor type.
<i>show</i>	Displays current temperature.
<i>all_data</i>	Displays all temperature data.

Example

```
> usb temp set -r
Show setting:temp set -r

Alarm Settings: 1 (0:Disable, 1: Enable.)
upper temperature limit: 30.0 C
lower temperature limit: 18.0 C
unit: 0 (0:Celsius, 1: Fahrenheit.)
sensor: 1 (0:Auto select, 1: built-in.)
```

Telnet Command: **vigbrg set**

This command is to configure specified WAN as bridge mode.

Syntax Description

vigbrg set -v <IP version> -w <WAN_idx> -l <LAN_idx> -e <0/1> -f <0/1>

Syntax Description

Parameter	Description
<i>-v <IP version></i>	Indicate the IP version for the IP address. 4 - IPv4. 6 - IPv6.
<i>-w <WAN_idx></i>	WAN_idx - Indicate the WAN interface. 1 - WAN1 2 - WAN2 3 - WAN3 4 - WAN4 5 - WAN5 ... 10 - WAN10
<i>-l <LAN_idx></i>	LAN_idx - Indicate the LAN interface.

	1 - LAN1 2 - LAN2 3 - LAN3 4 - LAN4 5 - LAN5 6 - LAN6 100 - LAN100
<i>e</i> <0/1>	Enable (1) or disable (0) the Vigor Bridge for WAN or/and LAN.
<i>f</i> <0/1>	Enable (1) or disable (0) the firewall functions.

Example

```
> vigbrg set -v 4 -w 10 -l 100 -e 1
[WAN10] IPv4 bridge is enable. Set subnet[LAN100]
```

Telnet Command: vigbrg closeall

This command can disable vigor bridge function.

Example

```
> vigbrg closeall
Close all bridge and bridge firewall
[WAN10] IPv4 firewall is disable.
```

Telnet Command: vigbrg status

This command can show whether the Vigor Bridge Function is enabled or disabled.

Example

```
> vigbrg status
%Vigor Bridge Function is enable!

%Wan1 management is disable!
```

Telnet Command: vigbrg cfgip

This command allows users to transfer a bridge modem into ADSL router by accessing into and adjusting specified IP address. Users can access into Web UI of the router to manage the router through the IP address configured here.

Syntax

vigbrg cfgip <IP Address>

Syntax Description

Parameter	Description
<IP Address>	It means to type an IP address for users to manage the router.

Example

```
> vigbrg cfgip 192.168.1.15
> vigbrg cfgip ?
% Vigor Bridge Config IP,
% Now: 192.168.1.15
```

Telnet Command: vigbrg wanstatus

This command can display the existed WAN connection status for the modem (change from ADSL router into bridge modem), including index number, MAC address, Stamp Time, PVC, VLAN port for Vigor Bridge Function.

Example

```
> vigbrg wanstatus
Vigor Bridge: Stop
WAN mac table:
Index   MAC Address           Stamp Time           PVC           VLan Port
>
```

Telnet Command: vigbrg wlanstatus

This command can display the existed WLAN connection status for the modem (change from router into bridge modem), including index number, MAC address, Stamp Time, PVC, VLAN port for Vigor Bridge Function.

Example

```
> vigbrg wlanstatus
Vigor Bridge: Running
WAN mac table:
Index   MAC Address           Stamp Time           PVC           VLan   Port
>
```

Telnet Command: vlan group

This command allows you to set VLAN group. You can set four VLAN groups. Please run *vlan restart* command after you change any settings.

Syntax

`vlan group id <add/add_ex/set/set_ex/show> <p2/p4/p9/p10/p11/p12>`

Syntax Description

Parameter	Description
<i>id</i>	It means the group 0 to 99 for VLAN.
<i>add/set</i>	It means to join the LAN port(s) to a VLAN group. Each port can join more than one VLAN group.
<i>add_ex/ set_ex</i>	It indicates each port can join one VLAN group at one time.
<i>p2/p4/p9/p10/p11/p12</i>	It indicates LAN port 2 to LAN port 12. To group LAN2, LAN4, LAN9, LAN10, LAN11 and/or LAN12 under one VLAN group, please type the port number(s) you want.

Example

```
> vlan group 3 set p1 p4
OK.
Use cmd 'vlan status' if you want to check result.
> vlan status
VLAN is Disable :
-----
VLAN Enable VID Pri  p1 p2 p3 p4 p5 p6 p7 p8 p9 p10 p11 p12  subnet
-----
0      OFF   0  0                1:LAN1
1      OFF   0  0                1:LAN1
2      OFF   0  0                1:LAN1
3      OFF   0  0          V   V          1:LAN1
4      OFF   0  0                1:LAN1
5      OFF   0  0                1:LAN1
6      OFF   0  0                1:LAN1
7      OFF   0  0                1:LAN1
8      OFF   0  0                1:LAN1
9      OFF   0  0                1:LAN1
10     OFF   0  0                1:LAN1
11     OFF   0  0                1:LAN1
12     OFF   0  0                1:LAN1
13     OFF   0  0                1:LAN1
14     OFF   0  0                1:LAN1
15     OFF   0  0                1:LAN1
16     OFF   0  0                1:LAN1
17     OFF   0  0                1:LAN1
18     OFF   0  0                1:LAN1

19     OFF   0  0                1:LAN1
--- MORE ---  ['q': Quit, 'Enter': New Lines, 'Space Bar': Next Page]
```

Telnet Command: vlan off

This command allows you to disable VLAN function.

Syntax

vlan off

Example

```
> vlan off
VLAN is Disable!
>
```

Telnet Command: vlan on

This command allows you to enable VLAN function.

Syntax

vlan on

Example

```
> vlan on
VLAN is Enable!
>
```

Telnet Command: vlan pri

This command is used to define the priority for each VLAN profile setting.

Syntax

vlan pri *n pri_no*

Syntax Description

Parameter	Description
<i>n</i>	It means VLAN ID number. n=VLAN ID number (from 0 to 7).
<i>pri_no</i>	It means the priority of VLAN profile. pri_no=0 ~7 (from none to highest priority).

Example

```
> vlan pri 1 2
VLAN1: Priority=2
>
```

Telnet Command: vlan restart

This command can make VLAN settings restarted with newest configuration.

Syntax

vlan restart

Example

```
> vlan restart ?
VLAN restarts!!!
>
```

Telnet Command: vlan status

This command display current status for VLAN.

Syntax

vlan status

Example

```

> vlan status
VLAN is Enable :
-----
VLAN Enable VID Pri p1 p2 p3 p4 p5 p6 p7 p8 p9 p10 p11 p12 subnet
-----
0 OFF 0 0 1:LAN1
1 OFF 0 0 1:LAN1
2 OFF 0 0 1:LAN1
3 OFF 0 0 V V 1:LAN1
4 OFF 0 0 1:LAN1
5 OFF 0 0 1:LAN1
6 OFF 0 0 1:LAN1
7 OFF 0 0 1:LAN1
8 OFF 0 0 1:LAN1
9 OFF 0 0 1:LAN1
10 OFF 0 0 1:LAN1
11 OFF 0 0 1:LAN1
12 OFF 0 0 1:LAN1
13 OFF 0 0 1:LAN1
14 OFF 0 0 1:LAN1
15 OFF 0 0 1:LAN1
16 OFF 0 0 1:LAN1
17 OFF 0 0 1:LAN1
18 OFF 0 0 1:LAN1

19 OFF 0 0 1:LAN1
--- MORE --- ['q': Quit, 'Enter': New Lines, 'Space Bar': Next Page]
>

```

Telnet Command: vlan subnet

This command is used to configure the LAN interface used by the VLAN group.

Syntax

vlan subnet group_id

<1/2/3/4/5/6/7/8/9/10/11/12/13/14/15/16/17/18/19/20/21/22/23/24/25/26/27/28/29/
30/31/32/33/34/35/36/37/38/39/40/41/42/43/44/45/46/47/48/49/50/51/52/53/54/55/5
6/57/58/59/60/61/62/63/64/65/66/67/68/69/70/71/72/73/74/75/76/77/78/79/80/81/82
/83/84/85/86/87/88/89/90/91/92/93/94/95/96/97/98/99/100>

Syntax Description

Parameter	Description
<1/2/3/4/5/6/7/8/9/10/ 11/12/13/14/15/16/17/1 8/19/20/21/22/23/24/25 /26/27/28/29/30/31/32/ 33/34/35/36/37/38/39/4 0/41/42/43/44/45/46/47 /48/49/50/51/52/53/54/ 55/56/57/58/59/60/61/6 2/63/64/65/66/67/68/69 /70/71/72/73/74/75/76/ 77/78/79/80/81/82/83/8 4/85/86/87/88/89/90/91 /92/93/94/95/96/97/98/	It means interfaces, LAN1 ~ LAN100.

```
99/100>
```

Example

```
> vlan subnet group_id 2
% Vlan Group-0 using LAN2      !
```

This setting will take effect after rebooting.
Please use "sys reboot" command to reboot the router.

Telnet Command: vlan submode

This command changes the VLAN encapsulation mechanisms in the LAN driver.

Syntax

```
vlan submode <on/off/status>
```

Syntax Description

Parameter	Description
<i>on</i>	It means to enable the promiscuous mode.
<i>off</i>	It means to enable the normal mode.
<i>status</i>	It means to display if submode is normal mode or promiscuous mode.

Example

```
> vlan submode status
% vlan subnet mode : normal mode
>
```

Telnet Command: vlan tagged

This command is used to enable or disable the incoming of untagged packets.

Syntax

```
vlan tagged <n> <on/off>
vlan tagged <unlimited> <on/off>
vlan tagged <p1_untag> <on/off>
```

Syntax Description

Parameter	Description
<i>n</i>	It means VLAN channel. The range is from 0 to 99.
<i>on/off</i>	It means to enable/disable the tagged VLAN.
<unlimited> <on/off>	unlimited on: It allows the incoming of untagged packets even all VLAN are tagged. unlimited off: It does not allows the incoming of untagged packets.
<p1_untag> <on/off>	P1_untag on: It allows the incoming of untagged packets form LAN port 1.

	P1_untag off: It does not allow the incoming of untagged packets from LAN port 1.
--	---

Example

```
> vlan tagged unlimited on
Unlimited mode is ON
>
```

Telnet Command: vlan vid

This command is used to configure VID number for each VLAN channel.

Syntax

vlan vid *n* *vid_no*

Syntax Description

Parameter	Description
<i>n</i>	It means VLAN channel. The range is from 0 to 7.
<i>vid_no</i>	It means the value of VLAN ID. Enter the value as the VLAN ID number. The range is form 0 to 4095.

Example

```
> vlan vid 1 4095
VLAN1, vid=4095
>
```

Telnet Command: vlan sysvid

This command is used to modify and show the scope (reserved 268) of the VLAN IDs used internally by the system.

Syntax

vlan sysvid *<show / n>*

Syntax Description

Parameter	Description
<i>show</i>	It means to show the scope of VLAN ID used internally.
<i>n</i>	It means the value to be set as VLAN ID. The range is from 0 to 3828.

Example

```
> vlan sysvid 100
You have set system VLAN ID to range: 100 ~ 367,
We recommend that you reboot the system now.
>
```

Telnet Command: vpn l2lset

This command allows users to set advanced parameters for LAN to LAN function.

Syntax

vpn l2lset <list index> peerid <peerid>

vpn l2lset <list index> localid <localid>

vpn l2lset <list index> main <auto/proposal index>

vpn l2lset <list index> aggressive <desg1/desg2/aesg1/aesg2/aesg5/aesg14>

vpn l2lset <list index> pfs <on/off>

vpn l2lset <list index> phase1 <lifetime>

vpn l2lset <list index> phase2 <lifetime>

vpn l2lset <list index> x509localid <0/1>

vpn l2lset <list index> compress <0/1/2/3>

Syntax Description

Parameter	Description
<list index> peerid <peerid>	It means to set the L2L (LAN to LAN) profile with peer identity for aggressive mode. <list index> - Enter the index number of L2L (LAN to LAN) profile. <peerid> - Enter the peer identity string for aggressive mode.
<list index> localid <localid>	It means to set L2L (LAN to LAN) profile with local identity for aggressive mode. <list index> - Enter the index number of L2L (LAN to LAN) profile. <localid> - Enter the local identity for aggressive mode.
<list index> main <auto/proposal index>	It means to choose proposal for main mode. <list index> - Enter the index number of L2L (LAN to LAN) profile. <auto/proposal index> - Select auto (choose default proposal), proposal (choose specified proposal.), or index number.
<list index> aggressive <desg1/desg2/aesg1/aesg2/ aesg5/aesg14>	It means the chosen DH group for aggressive mode. <list index> - Enter the index number of L2L (LAN to LAN) profile. <desg1/desg2/aesg1/aesg2/aesg5/aesg14> - Select one of them.
<list index> pfs <on/off>	It means "perfect forward secrete". <list index> - Enter the index number of L2L (LAN to LAN) profile. <on/off>: Turn on or off the PFS function.
<list index> phase1 <lifetime> / phase2 <lifetime>	It means phase 1 or 2 of IKE. <list index> - Enter the index number of L2L (LAN to LAN) profile. <lifetime>: Set the lifetime value (in second) for phase 1 and phase 2.
<list index> x509localid <0/1>	It means to enable (1) or disable (0) the X509 local ID. <list index> - Enter the index number of L2L (LAN to LAN) profile.
compress <0/1/2/3>	Select a method to compress the packets to reduce the bandwidth usage while transferring the compressed packets. <0/1/2/3> - Available values are: 0 : Disable the function of compression. 1 : No . Use the Adaptive method for packet compression. 2 : LZ4. Use the algorithm of LZ4 for packet compression.

3 : LZO. For future use.

Example

```
> VPN l2lset 1 peerid 10226
```

Telnet Command: vpn l2IDrop

This command allows users to terminate current LAN to LAN VPN connection.

Syntax

```
vpn l2IDrop l2lname <name>
```

```
vpn l2IDrop l2lidx <idx>
```

```
vpn l2IDrop h2lname <name>
```

```
vpn l2IDrop h2lidx <idx>
```

```
vpn l2IDrop <ifno>
```

```
vpn l2IDrop
```

Syntax Description

Parameter	Description
<i>l2lname <name></i>	It means to drop VPN connection by specifying the name of the LAN to LAN profile.
<i>l2lidx <idx></i>	It means to drop VPN connection by specifying the index number of LAN to LAN profile (1 to 500).
<i>h2lname <name></i>	It means to drop VPN connection by specifying the name of the remote dial-in user profile.
<i>h2lidx <idx></i>	It means to drop VPN connection by specifying the index number of the remote dial-in user profile(1 to 500).
<i><ifno></i>	It means to drop VPN connection by using VPN ifno. This is for debug only.

Example

```
> vpn l2lDrop
% Drop all VPN
```

Telnet Command: vpn l2IDialout

This command allows users to terminate current LAN to LAN VPN connection (dial-out).

Syntax

```
vpn l2IDialout <idx>
```

Syntax Description

Parameter	Description
<i>l2IDialout <idx></i>	It means to build VPN connection by specifying the index number of dial-out LAN to LAN profile. <idx>: Enter an index number (1 to 500).

<i>list</i>	It means to display LAN to LAN profiles (enabled).
-------------	--

Example

```
> vpn l2lDialout list
List LAN to LAN profiles of the status as Enable
Index Profile Active Status
```

Telnet Command: vpn dinset

This command allows users to configure setting for remote dial-in VPN profile.

Syntax

```
vpn dinset <list index>
vpn dinset <list index> <on/off>
vpn dinset <list index> username <USERNAME>
vpn dinset <list index> password <PASSWORD>
vpn dinset <list index> motp <on/off>
vpn dinset <list index> pin_secret <pin> <secret>
vpn dinset <list index> timeout <0-9999>
vpn dinset <list index> dintype <Type> <on/off>
vpn dinset <list index> subnet <0-8>
vpn dinset <list index> assignip <on/off>
vpn dinset <list index> srnode <on/off>
vpn dinset <list index> remoteip <Remote_Client_IP_Address>
vpn dinset <list index> peer <Peer_ID>
vpn dinset <list index> naming <pass/block>
vpn dinset <list index> multicastvpn <pass/block>
vpn dinset <list index> prekey <on/off>
vpn dinset <list index> assignkey <Pre_Shared_Key>
vpn dinset <list index> digsig <on/off>
vpn dinset <list index> ipsec <Method> <on/off>
vpn dinset <list index> localid <Local_ID>
```

Syntax Description

Parameter	Description
<i><list index></i>	It means the index number of the profile.
<i><list index> <on/off></i>	It means to enable or disable the profile. <list index> - Enter the index number of the VPN profile. <on/off> - on: Enable; off: Disable.
<i><list index> motp <on/off></i>	It means to enable or disable the authentication with mOTP function. <list index> - Enter the index number of the VPN profile. <on/off> - on: Enable; off: Disable.

<i><list index> pin_secret<pin> <secret></i>	It means to set PIN code with secret. <list index> - Enter the index number of the VPN profile. <pin> - Type the code for authentication (e.g., 1234). <secret> - Use the 32 digit-secret number generated by mOTP in the mobile phone (e.g., e759bb6f0e94c7ab4fe6)
<i><list index> timeout <0-9999></i>	It means to set idle timeout. The default is 300 (seconds). <list index> - Enter the index number of the VPN profile. <0-9999> - Enter a value.
<i><list index> dintype <Type> <on/off></i>	It means to enable/disable the allowed dial-in type. <list index> - Enter the index number of the VPN profile. <Type> - 0 to 3. In which, 0 means PPTP; 1 means IPsec Tunnel; 2 means L2TP with IPsec Policy; 3 means SSL Tunnel. <on/off> - on: Enable; off: Disable.
<i>vpn dinset <list index> subnet <0-8></i>	It means to set the LAN subnet for the selected VPN profile. <list index> - Enter the index number of the VPN profile. <0-100> - Enter a number to specify the LAN subnet. In which, 0 means LAN1 1 means LAN2 2 means LAN3 3 means LAN4 ... 100 means LAN100
<i>vpn dinset <list index> assignip <on/off></i>	It means to enable or disable the function of assigning the static IP address. <list index> - Enter the index number of the VPN profile. <on/off> - on: Enable; off: Disable.
<i>vpn dinset <list index> srnode <on/off></i>	It means to enable or disable the function of specifying the remote node. <list index> - Enter the index number of the VPN profile. <on/off> - on: Enable; off: Disable.
<i>vpn dinset <list index> remoteip <Remote_Client_IP_Address></i>	It means to enable or disable the function of assigning remote client IP. <list index> - Enter the index number of the VPN profile. <Remote_Client_IP_Address> - Set the IP address of the remote client.
<i>vpn dinset <list index> peer <Peer_ID></i>	It means to assign the peer ID. <list index> - Enter the index number of the VPN profile. <Peer_ID> - Enter the string of the peer ID.
<i>vpn dinset <list index> naming <pass/block></i>	It means to set the Netbioid Naming Packet for the VPN profile. <list index> - Enter the index number of the VPN profile. <pass/block> - Let the packet pass or block the packet.
<i>vpn dinset <list index> multicastvpn</i>	It means to set the multicast via VPN for IGMP, IP-CAM, DHCP

<i><pass/block></i>	relay, and etc. <list index> - Enter the index number of the VPN profile. <pass/block> - Let the packet pass or block the packet.
<i>vpn dinset <list index> prekey <on/off></i>	It means to enable/disable the Pre-Shared Key setting for IKE Authentication Method. <list index> - Enter the index number of the VPN profile. <on/off> - on: Enable; off: Disable.
<i>vpn dinset <list index> assignkey <Pre_Shared_Key></i>	It means to set the Pre-Shared Key for IKE Authentication Method. <list index> - Enter the index number of the VPN profile. <Pre_Shared_Key> - Enter a string as PSK.
<i>vpn dinset <list index> digsig <on/off></i>	It means to enable/disable the digital signature (X.509) for IKE Authentication Method. <list index> - Enter the index number of the VPN profile. <on/off> - on: Enable; off: Disable.
<i>vpn dinset <list index> ipsec <Method> <on/off></i>	It means to enable / disable and set the protocol for IPsec security method. <list index> - Enter the index number of the VPN profile. <Method> - Enter a number (0 to 3) to specify the protocol. 0 means Medium(AH) High(ESP), 1 means DES 2 means 3DES 3 means AES <on/off> - on: Enable; off: Disable.
<i>vpn dinset <list index> localid <Local_ID></i>	It means to set local ID (optional) for IPsec Security Method. <list index> - Enter the index number of the VPN profile. <local_ID> - Enter the string of local ID.

Example

```

> vpn dinset 1
Dial-in profile index 1
Profile Name: ???
Status: Deactive
Mobile OTP: Disabled
Password:
Idle Timeout: 300 sec
> vpn dinset 1 on
% set profile active
> vpn dinset 1 motp on
% Enable Mobile OTP mode!>
> vpn dinset 1 pin_secret 1234 e759bb6f0e94c7ab4fe6
> vpn dinset 1
Dial-in profile index 1
Profile Name: ???
Status: Active
Mobile OTP: Enabled
PIN: 1234
Secret: e759bb6f0e94c7ab4fe6
Idle Timeout: 300 sec

```

Telnet Command: vpn subnet

This command allows users to specify a subnet selection for the specified remote dial-in VPN profile.

Syntax

vpn subnet <index> <1/2/3/.../100>

Syntax Description

Parameter	Description
<index>	It means the index number of the VPN profile.
<1/2/3/.../100>	1 - it means LAN1 2 - it means LAN2. 3 - it means LAN3 ... 100 - it means LAN100.

Example

```
> vpn subnet 1 2
>
```

Telnet Command: vpn setup

This command allows users to setup VPN for different types.

Syntax

Command of PPTP Dial-Out

vpn setup <index> <name> pptp_out <ip> <usr> <pwd> <nip> <nmask>

Command of IPsec Dial-Out

vpn setup <index> <name> ipsec_out <ip> <key> <nip> <nmask>

Command of L2Tp Dial-Out

vpn setup <index> <name> l2tp_out <ip> <usr> <pwd> <nip> <nmask>

Command of Dial-In

vpn setup <index> <name> dialin <ip> <usr> <pwd> <key> <nip> <nmask>

Syntax Description

Parameter	Description
For PPTP Dial-Out	
<index>	It means the index number of the profile.
<name>	It means the name of the profile.
<ip>	It means the IP address to dial to.
<usr> <pwd>	It means the user and the password required for the PPTP connection.
<nip> <nmask>	It means the remote network IP and the mask. e.g., vpn setup 1 name1 pptp_out 1.2.3.4 vigor 1234 192.168.1.0 255.255.255.0
For IPsec Dial-Out	

<index>	It means the index number of the profile.
<name>	It means the name of the profile.
<ip>	It means the IP address to dial to.
<key>	It means the value of IPsec Pre-Shared Key.
<nip> <nmask>	It means the remote network IP and the mask. e.g., vpn setup 1 name1 ipsec_out 1.2.3.4 1234 192.168.1.0 255.255.255.0
For L2TP Dial-Out	
<index>	It means the index number of the profile.
<name>	It means the name of the profile.
<ip>	It means the IP address to dial to.
<usr> <pwd>	It means the user and the password required for the L2TP connection.
<nip> <nmask>	It means the remote network IP and the mask. e.g.,, vpn setup 1 name1 l2tp_out 1.2.3.4 vigor 1234 192.168.1.0 255.255.255.0
For Dial-In	
<index>	It means the index number of the profile.
<name>	It means the name of the profile.
<ip>	It means the IP address allowed to dial in.
<usr> <pwd>	It means the user and the password required for the PPTP/L2TP connection.
<key>	It means the value of IPsec Pre-Shared Key.
<nip> <nmask>	It means the remote network IP and the mask. e.g., vpn setup 1 name1 dialin 1.2.3.4 vigor 1234 abc 192.168.1.0 255.255.255.0

Example

```
> vpn setup 1 name1 dialin 1.2.3.4 vigor 1234 abc 192.168.1.0
255.255.255.0
% Profile Change Log ...

% Profile Index : 1
% Profile Name : name1
% Username : vigor
% Password : 1234
% Pre-share Key : abc
% Call Direction : Dial-In
% Type of Server : ISDN PPTP IPsec L2TP
% Dial from : 1.2.3.4
% Remote Network IP : 192.168.1.0
% Remote Network Mask : 255.255.255.0
>
```

Telnet Command: vpn option

This command allows users to configure settings for LAN to LAN profile.

Syntax

vpn option <index> <cmd1>=<param1> [<cmd2>=<para2> | ...]

Syntax Description

Parameter	Description
<index>	It means the index number of the profile. Available index numbers: 1 ~ 500
For Common Settings	
<index>	It means the index number of the profile.
<i>pname</i>	It means the name of the profile.
<i>ena</i>	It means to enable or disable the profile. on - Enable off - Disable
<i>thr</i>	It means the way that VPN connection passes through. Available settings are w1f, w1o, w2f, w2o, w1oB and w2oB. w1f - WAN1 First. w1o - WAN1 Only. w2f - WAN2 First. w2o - WAN2 Only. w1oB - WAN1 Only (Only establish VPN if WAN2 down) w2oB - WAN2 Only (Only establish VPN if WAN1 down)
<i>thr_ai</i>	It means connection through WAN IP alias. 0 - do not use alias. 1/2/.../299 - Use the allias IP (index number 1 to 299).
<i>nnpkt</i>	It means the NetBios Naming Packet. on - Enable the function to pass the packet. off - Disable the function to block the packet.
<i>dir</i>	It means the call direction. Available settings are b, o and i. b - Both o - Dial-Out i - Dial-In.
<i>idle=[value]</i>	It means Always on and Idle Time out. Available values include: -1 - it means always on for dial-out. 0 - it means always on for dial-in. Other numbers (e.g. , idle=200, idle=300, idle=500) mean the router will be idle after the interval (seconds) configured here.
<i>palive</i>	It means to enable PING to keep alive. -1 - disable the function. 1,2,3,4 - Enable the function and PING IP 1.2.3.4 to keep alive.
<i>monitor</i>	It means to enable Quality Monitoring. On - Turn on Quality Monitoring. Off - Turn off Quality Monitoring.
For Dial-Out Settings	

<i>ctype</i>	It means "Type of Server I am calling". ctype=t means PPTP. ctype=s means IPSec. ctype= l means L2TP(IPSec Policy None). ctype= l1 means L2TP(IPSec Policy Nice to Have). ctype= l2 means L2TP(IPSec Policy Must). ctype= c means SSL Tunnel ctype=o [0/1/2/3/4/5] [0/1/2/3] means Openvpn TCP Tunnel[AES128/AES256/NONE/AES128_GCM/AES192_GCM/AES256_GCM] [SHA1/SHA256/NONE/SHA512] ctype= u[0/1/2/3/4/5][0/1/2/3] means Openvpn UDP Tunnel[AES128/AES256/NONE/AES128_GCM/AES192_GCM/AES256_GCM][SHA1/SHA256/NONE/SHA512]
<i>dialto</i>	It means Server IP/Host Name for VPN. (such as draytek.com or 123.45.67.89).
<i>ltype</i>	It means Link Type. "ltype=0" means "Disable". "ltype=1" means "64kbps". "ltype=2" means "128kbps". "ltype=3" means "BOD".
<i>oname</i>	It means Dial-Out Username. "oname=admin" means to set Username = admin.
<i>opwd</i>	It means Dial-Out Password "opwd=1234" means to set Password = 1234.
<i>pauth</i>	It means PPP Authentication. "pauth=pc" means to set PPP Authentication = PAP&CHAP. "pauth=p" means to set PPP Authentication = PAP Only
<i>ovj</i>	It means VJ Compression. "ovj=on/off" means to enable/disable VJ Compression.
<i>okey</i>	It means IKE Pre-Shared Key. "okey=abcd" means to set IKE Pre-Shared Key = abcd.
<i>ometh</i>	It means IPSec Security Method. "ometh=ah/" means AH. "ometh=espd/espda [a/m/s/S]" means ESP DES without/with Authentication (Auto, MD5, SHA1 or SHA2). "ometh=esp3/esp3a [a/m/s/S]" means ESP 3DES without/with Authentication (Auto, MD5, SHA1 or SHA2). "ometh=espa [1/9/2']/espaa [a/m/s/S] [1/9/2']" means ESP AES (128, 192, or 256) without/with Authentication (Auto, MD5, SHA1 or SHA2) (128, 192, or 256).
<i>tls_auth</i>	It means to Turn off/on tls-auth option.
<i>tls_auth_key</i>	It means to set OpenVPN tls-auth option key. tls-auth_key=<1/2/3> Enter the number to select the PSK.
<i>tls_key_show</i>	It means to show the selected PSK.
<i>sch</i>	It means Index(1-15) in Schedule Setup. sch=1,3,5,7 Set schedule 1->3->5->7
<i>ikemode</i>	It means to set IKE phase 1 mode. "ikemode=m/a" means the IKE phase 1 mode will be set as Main Mode / Aggressive Mode.
<i>ikeid</i>	It means IKE Local ID.

	"ikeid=vigor" means Set Local ID = vigor.
<i>oport</i>	It means OpenVPN Dial-Out Port. oport=1194. Set OpenVPN Dial-Out Port = 1194
For Dial-In Settings	
<i>itype</i>	It means Allowed Dial-In Type. Available settings include: "itype=t" means PPTP. "itype=s" means IPsec. "itype=L" means L2TP (None). "itype=l1" means L2TP(Nice to Have). "itype=l2" means L2TP(Must). "itype=c" means SSL Tunnel "itype=i" means Openvpn UDP/TCP "itype=i[0/1/2][0/1/2]" means Tunnel[AES128/AES256/NONE][SHA1/SHA256/NONE]/ "itype=o[0/1/2][0/1/2]" means Openvpn TCP Tunnel[AES128/AES256/NONE][SHA1/SHA256/NONE]/ "itype=u[0/1/2][0/1/2]" means Openvpn UDP Tunnel[AES128/AES256/NONE][SHA1/SHA256/NONE]
<i>peer</i>	It means specify Peer VPN Server IP for Remote VPN Gateway. Type "203.12.23.48" means to allow VPN dial-in with IP address of 203.12.23.48. Type "off" means any remote IP is allowed to dial in.
<i>peerid</i>	It means the peer ID for Remote VPN Gateway. Type "draytek" means the word is used as local ID.
<i>iname</i>	It means Dial-in Username. "iname=admin" means to set username as "admin" .
<i>ipwd</i>	It means Dial-in Password. "ipwd=1234" means to set password as "1234" .
<i>ivj</i>	It means VJ Compression. "ivj=on/off" means to enable /disable VJ Compression.
<i>ikekey</i>	It means IKE Pre-Shared Key. "ikekey=abcd" means to set IKE Pre-Shared Key = abcd.
<i>imeth</i>	It means IPsec Security Method "imeth=h" means "Allow AH". "imeth=d" means "Allow DES". "imeth=3" means "Allow 3DES". "imeth=a" means "Allow AES".
For TCP/IP Settings	
<i>mywip</i>	It means My WAN IP. "mywip=1.2.3.4" means to set My WAN IP as "1.2.3.4" .
<i>rgip</i>	It means Remote Gateway IP. "rgip=1.2.3.4" means to set Remote Gateway IP as "1.2.3.4" .
<i>rnip</i>	It means Remote Network IP. "rnip=1.2.3.0" means to set Remote Network IP as "1.2.3.0" .
<i>rnmask</i>	It means Remote Network Mask. "rnmask=255.255.255.0" means to set Remote Network Mask as "255.255.255.0" .
<i>lnip</i>	It means the local network IP. "lnip=1.2.3.0" means to set the local network IP as "1.2.3.0".

<i>Inmask</i>	It means the local Network Mask. "rnmask=255.255.255.0" means to set the local Network Mask as "255.255.255.0".
<i>rip</i>	It means RIP Direction. "rip=d" means to set RIP Direction as "Disable". "rip=t" means to set RIP Direction as "TX". "rip=r" means to set RIP Direction as "RX". "rip=b" means to set RIP Direction as "Both".
<i>mode</i>	It means the option of "From first subnet to remote network, you have to do". "mode=r" means to set Route mode. "mode=n" means to set NAT mode.
<i>droute</i>	It means to Change default route to this VPN tunnel (Only single WAN supports this). droute=on/off means to enable/disable the function.

Example

```
> vpn option 1 idle=250
% Change Log..

% Idle Timeout = 250
> vpn option 33 pname=carrietest
% Change Log..

% Profile Name = carrietest
```

Telnet Command: vpn mroute

This command allows users to list, add or delete static routes for a certain LAN to LAN VPN profile.

Syntax

vpn mroute <index> list

vpn mroute <index> add <network ip>/<mask>

vpn mroute <index> del <network ip>/<mask>

vpn mroute <index> addmsa <local network ip>/<mask> <remote network ip>/<mask>

vpn mroute <index> delmsa <local network ip>/<mask> <remote network ip>/<mask>

Syntax Description

Parameter	Description
<i>list</i>	It means to display all of the route settings.
<i>add</i>	It means to add a new route.
<i>del</i>	It means to delete specified route.
<i>addmsa</i>	It means to add an IPsec multiple SA in a route profile.
<i>delmsa</i>	It means to delete IPsec multiple SA in a route profile.
<index>	It means the index number of the profile. Available index numbers: 1 ~ 500

<i><network ip>/<mask></i>	Enter the IP address with the network mask address.
<i><local network ip>/<mask></i>	Enter the local IP address with the network mask address.
<i><remote network ip>/<mask></i>	Enter the remote IP address with the network mask address.

Example

```
> vpn mroute 1 add 192.168.5.0/24
% 192.168.5.0/24
% Add new route 192.168.5.0/24 to profile 1
```

Telnet Command: vpn list

This command allows users to view LAN to LAN VPN profiles.

Syntax

```
vpn list <index> all
vpn list <index> com
vpn list <index> out
vpn list <index> in
vpn list <index> net
```

Syntax Description

Parameter	Description
<i>all</i>	It means to list configuration of the specified profile.
<i>com</i>	It means to list common settings of the specified profile.
<i>out</i>	It means to list dial-out settings of the specified profile.
<i>in</i>	It means to list dial-in settings of the specified profile.
<i>net</i>	It means to list Network Settings of the specified profile.
<i><index></i>	It means the index number of the profile. Available index numbers: 1 ~ 500

Example

```
> vpn list 32 all
% Common Settings

% Profile Name           : ???
% Profile Status        : Disable
% Netbios Naming Packet : Pass
% Call Direction        : Both
% Idle Timeout          : 300
% PING to keep alive    : off

% Dial-out Settings

% Type of Server         : PPTP
% Link Type:             : 64k bps
% Username              : ???
% Password              :
```

```

% PPP Authentication      : PAP/CHAP
% VJ Compression        : on
% Pre-Shared Key        :
% IPSec Security Method : AH
% Schedule              : 0,0,0,0
% Remote Callback       : off
% Provide ISDN Number   : off
% IKE phase 1 mode      : Main mode
% IKE Local ID          :

% Dial-In Settings

--- MORE --- ['q': Quit, 'Enter': New Lines, 'Space Bar': Next Page] ---
> vpn list 1 com
% Common Settings

% Profile Name          : ???
% Profile Status        : Disable
% Netbios Naming Packet : Pass
% Call Direction        : Both
% Idle Timeout          : 300
% PING to keep alive    : off
>

```

Telnet Command: vpn remote

This command allows users to enable or disable *PPTP/IPSec/L2TP/SSL VPN/OpenVPN/WireGuard* VPN service.

Syntax

```
vpn remote <PPTP/IPsec/L2TP/SSLVPN/OpenVPN/WireGuard><on/off>
```

```
vpn remote <PPTP/IPsec/L2TP/SSLVPN/OpenVPN/WireGuard> <wan1/wan2/...> <on/off>
```

Syntax Description

Parameter	Description
<PPTP/IPsec/L2TP/SSLVPN/OpenVPN/WireGuard>	There are several types to be selected.
<on/off>	on - enable VPN remote setting. off - disable VPN remote setting.
<wan1/wan2/...>	Specify WAN interface for the service.

Example

```

> vpn remote PPTP on
Set PPTP VPN Service : On

Please restart the router!!

```

Telnet Command: vpn trunk

This command allows users to configure VPN Backup, VPN load balance, GRE over IPsec, and Binding tunnel policy.

```

vpn trunk show_usable
vpn trunk backup <add/del> <name> <Member#1> <Member#2>
vpn trunk backup more_syslog <ON/OFF>
vpn trunk backup ERD <name> <Normal/Recover/Resume><second>
vpn trunk lb <add/del> <name> <Member#1> <Member#2>
vpn trunk lb more_syslog <ON/OFF>
vpn trunk lb algorithm <name><RR/W-RR/ Fastest>
vpn trunk bind usage <BindIndex>
vpn trunk bind show <LoadBalanceName>
vpn trunk bind reset_default
vpn trunk bind more_syslog <ON/OFF>
vpn trunk bind set <BindIndex> <ACT> <TrunkName> <Member> <SrcIp:A-B> <DstIp:A-B>
<DstPort:A-B> <Proto> <Frag>
vpn trunk bind insert <After_BindIndex> <ACT> <TrunkName> <Member> <SrcIp:A-B>
<DstIp:A-B> <DstPort:A-B> <Proto> <Frag>
vpn trunk SetGre show <Dialout_Index>
vpn trunk SetGre
<Active/In-active><Dialout_Index><GRE_MyIP><GRE_PeerIP><Logical_Traffic>
vpn trunk An_Gre GreIPsecAnalyze <ON/OFF>

```

Syntax Description

Parameter	Description
<i>show_usable</i>	Display a list of LAN to LAN dial out profiles.
<i>backup <add/del> <name> <Member#1> <Member#2></i>	Set multiple VPN tunnels (LAN to LAN profiles) as backup tunnel. add/del - Add or delete a profile for used in VPN Trunk. name - Specify the name of the VPN trunk. Member#1 - Indicate the first LAN to LAN profile. Member#2 - Indicate the second LAN to LAN profile.
<i>backup more_syslog <ON/OFF></i> <i>lb more_syslog <ON/OFF></i> <i>bind more_syslog <ON/OFF></i>	These commands are used for RD debug.
<i>backup ERD <name> <Normal/Recover/Resume><second></i>	ERD means Environment Recovers Detection. name - Specify the name of the VPN trunk. Normal - Indicate the Normal mode. All dial-out VPN TRUNK backup profiles will be activated alternatively. Recover - Indicate the duration of VPN backup operation. Resume - When VPN connection breaks down or disconnects, Member 1 will be the top priority for the system to do VPN connection. Second - "0" means to dial each six seconds automatically. "60 - 2147483647" means to early handle for less than 30 seconds within designated time.
<i>lb <add/del> <name> <Member#1> <Member#2></i>	It means to create VPN trunk with load balance. add/del - Add or delete a profile for used in VPN Trunk. name - Specify the name of the VPN trunk. Member#1 - Indicate the first LAN to LAN profile. Member#2 - Indicate the second LAN to LAN profile.
<i>lb more_syslog <ON/OFF></i>	It means to enable (ON) or disable (OFF) the syslog records.
<i>lb algorithm <name> <RR/W-RR/Fastest></i>	Set multiple VPN tunnels for using as traffic load balance tunnel. Such command is to configure the algorithm (with round robin

	<p>mode) of Load Balance.</p> <p>name - Specify the name of the VPN trunk.</p> <p>RR - It means round robin mode. All of the dial-out profiles will be taken turns equally.</p> <p>Fastest - Configure the algorithm (with fastest mode) of Load Balance.</p>
<p><i>lb algorithm</i> <name><W-RR><Auto> <AccordingRatio> <Member1:Member2></p>	<p>Such command is to configure the algorithm (with round robin mode) of Load Balance.</p> <p>name - Specify the name of the VPN trunk.</p> <p>W-RR - It means weighted round robin mod based on speed ratio.</p> <ul style="list-style-type: none"> ● <i>Auto</i> - the speed must be based on Lay2. ● <i>AccordingRatio</i> - the speed must be based on given ratio. <p>Member#1 - Indicate the first LAN to LAN profile.</p> <p>Member#2 - Indicate the second LAN to LAN profile.</p>
<p><i>lb algorithm</i> <name><Fastest></p>	<p>Such command is to configure the algorithm (with fastest mode) of Load Balance. Most of traffics will be led to the channel with the fastest connection.</p> <p>name - Specify the name of the VPN trunk.</p>
<p><i>bind usage</i> <BindIndex></p>	<p>Display detailed information for VPN Load Balance Tunnel Bind.</p> <p>BindIndex - Indicate the index number of the tunngle bind.</p>
<p><i>bind show</i> <LoadBalanceName></p>	<p>Display the bind information for VPN Load Balance profile.</p> <p>LoadBalanceName - type the name of VPN Load Balance profile</p>
<p><i>bind reset_default</i></p>	<p>Reset the bind tunnel for VPN load balance to factory reset settings.</p>
<p><i>bind more_syslog</i> <ON/OFF></p>	<p>It means to enable (ON) or disable (OFF) the syslog records.</p>
<p><i>bind set</i> <BindIndex> <ACT> <TrunkName> <Member> <SrcIp:A-B> <DstIp:A-B> <DstPort:A-B> <Proto> <Frag></p>	<p>Set the binding tunnel policy.</p> <p>BindIndex - Indicate the index number (1 ~ 64) for the tunnel to be bound.</p> <pre> vpn trunk bind set 1 y vpnlb 1 192.168.10.1~192.168.10.2 192.168.99.1~192.168.99.254 1~65535 0 OFF </pre> <p>ACT - Specify the action. "y" means active; "n" means inactive or delete.</p> <p>TrunkName - TrunkName - Specify the name of the VPN trunk created by using "vpn trunk lb" command.</p> <p>Member - Specify the index number of the LAN to LAN (dial-out) profile to be bound.</p> <p>SrcIp:A-B - Specify the source IP range (e.g., 192.168.10.0-192.168.10.255).</p> <p>DstIp:A-B - Specify the destination IP range (e.g., 192.168.1.0-192.168.1.255).</p> <p>DstPort:A-B - Specify the destination port range (1-65535).</p> <p>Proto - Specify the protocol.</p> <ul style="list-style-type: none"> 0 - any 1 - ICMP 2 - IGMP 6 - TCP 17 - UDP 255 - TCP/UDP <p>Frag - "ON" means to bind the fragmented packet; "OFF" means not to care. It is the default setting.</p>
<p><i>bind insert</i> <After_BindIndex> <ACT> <TrunkName> <Member> <SrcIp:A-B> <DstIp:A-B> <DstPort:A-B> <Proto></p>	<p>It is used to insert additional load balance policy into an existing policy.</p> <p>After_BindIndex - Specify an index number that new additional policy should be inserted before. See the following example:</p>

<i><Frag></i>	<pre>vpn trunk bind insert 1 y vpnlb 2 192.168.10.3~192.168.10.200 192.168.99.200~192.168.99.200 80~80 TCP OFF</pre> <p>ACT - Specify the action. "y" means active; "n" means inactive or delete.</p> <p>TrunkName - Specify the name of the VPN trunk.</p> <p>Member - Specify the index number of the LAN to LAN (dial-out) profile to be bound.</p> <p>Srclp:A-B - Specify the source IP range (e.g., 192.168.10.0~192.168.10.255).</p> <p>Dstl p:A-B - Specify the destination IP range (e.g., 192.168.1.0~192.168.1.255).</p> <p>DstPort:A-B - Specify the destination port range (1~65535).</p> <p>Proto - Specify the protocol.</p> <ul style="list-style-type: none"> 0 - any 1 - ICMP 2 - IGMP 6 - TCP 17 - UDP 255 - TCP/UDP <p>Frag - "ON" means to bind the fragmented packet; "OFF" means not to care. It is the default setting.</p>
<i>SetGre show</i> <i><Dialout_Index></i>	<p>Display the GRE over IPsec settings in specified LAN to LAN profile.</p> <p>Dialout_Index - Index number of the LAN to LAN (dial-out) profile.</p>
<i>SetGre</i> <i><Active/In-active><Dialout_Index><GRE_MyIP><GRE_PeerIP><Logical_Traffic></i>	<p>Active/In-active - Specify the action. "y" means active; "n" means inactive.</p> <p>Dialout_Index - Index number of the LAN to LAN (dial-out) profile.</p> <p>GRE_MyIP -Enter the virtual IP for router itself for verified by peer.</p> <p>GRE_PeerIP -Enter the virtual IP of peer host for verified by router.</p> <p>Logical_Traffic - Specify the action for RFC2890. "y" means active; "n" means inactive.</p>
<i>An_Gre GreIPsecAnalyze</i> <i><ON/OFF></i>	<p>These commands are used for RD debug.</p>

Example

```
> vpn setup 1 name1 pptp_out 1.2.3.4 vigor 1234 192.168.1.0 255.255.255.0
% Profile Change Log ...

% Profile Index : 1
% Profile Name : name1j
% Username : vigor
% Password : 1234
% Call Direction : Dial-Out
% Type of Server : PPTP
% Dial to : 1.2.3.4
% Remote NETwork IP : 192.168.1.0
% Remote NETwork Mask : 255.255.255.0
> vpn setup 2 market pptp_out 5.6.7.8 vigor 5678 192.168.1.31 255.255.255.0
% Profile Change Log ...

% Profile Index : 2
% Profile Name : market
% Username : vigor
% Password : 5678
% Call Direction : Dial-Out
% Type of Server : PPTP
% Dial to : 5.6.7.8
% Remote NETwork IP : 192.168.1.31
% Remote NETwork Mask : 255.255.255.0
```

```

> vpn trunk lb add comp 1 2
%% Combination VPN Load Balance profile list :
  <Index> < Name > < Member1(Active)Type > <
Member2(Act
ive)Type >
  1 comp 1(YES)PPTP 2(YES)P
PTP

%% Note: <Active: NO> The LAN-to-LAN Profile is disable or under Dial-In(Call
Di
rection) at present.
=====

% Setting OK.
> vpn trunk bind set 1 y comp 2 192.168.10.1~192.168.10.2
192.168.99.1~192.168.99.254 1~65535 0 OFF
% VPN Load Balance Tunnel Bind Table Index[1] detail:
=====
Action = ACTIVE
Trunk Profile(000) Name= comp
Binding Dial Out Index = 2
Binding Src IP = 192.168.10.1 ~ 192.168.10.2
Binding Dest IP = 192.168.99.1 ~ 192.168.99.254
Binding Dest Port = 1 ~ 65535
Binding Fragmented = NO
Binding Protocol = ANY Protocol
>

```

Telnet Command: vpn NetBios

This command allows users to enable or disable NetBios for Remote Access User Accounts or LAN-to-LAN Profile.

Syntax

```
vpn NetBios set <H2I/L2I> <index> <Block/Pass>
```

Syntax Description

Parameter	Description
<H2I/L2I>	H2I means Remote Access User Accounts. L2I means LAN-to-LAN Profile. Specify which one will be applied by NetBios.
<index>	The index number (1 to 500) of the profile.
<Block/Pass>	Pass - Have an inquiry for data transmission between the hosts located on both sides of VPN Tunnel while connecting. Block - When there is conflict occurred between the hosts on both sides of VPN Tunnel in connecting, set it block data transmission of Netbios Naming Packet inside the tunnel.

Example

```

> vpn NetBios set H2I 1 Pass
% Remote Dial In Profile Index [1] :
% NetBios Block/Pass: [PASS]

```

Telnet Command: vpn mss

This command allows users to configure the maximum segment size (MSS) for different TCP types.

Syntax

`vpn mss show`

`vpn mss default`

`vpn mss set <connection type> <TCP maximum segment size range>`

Syntax Description

Parameter	Description
<i>show</i>	It means to display current setting status.
<i>default</i>	TCP maximum segment size for all the VPN connection will be set as 1360 bytes.
<i>set</i>	Use it to specify the connection type and value of MSS.
<i><connection type></i>	1-7 represent various type. 1 - PPTP 2 - L2TP 3 - IPsec 4 - L2TP over IPsec 5 - GRE over IPsec 6 - SSL Tunnel 7 - WireGuard
<i><TCP maximum segment size range></i>	Each type has different segment size range. PPTP - 512 ~ 1412 L2TP - 512 ~ 1408 IPsec - 512 ~ 1381 L2TP over IPsec - 512 ~ 1361 GRE over IPsec - 512 ~ 1365 SSL Tunnel - 512 ~ 1360 WireGuard VPN - 512 ~1380

Example

```
>vpn mss set 1 1400
% VPN TCP maximum segment size (MSS) :
  PPTP = 1400
  L2TP = 1360
  IPsec = 1360
  L2TP over IPsec = 1360
  GRE over IPsec = 1360
  SSL Tunnel = 1260
  WireGuard VPN = 1372
>vpn mss show
VPN TCP maximum segment size (MSS) :
  PPTP = 1400
  L2TP = 1360
  IPsec = 1360
  L2TP over IPsec = 1360
  GRE over IPsec = 1360
  SSL Tunnel = 1260
```

Telnet Command: vpn ike

This command is used to display IKE memory status and leakage list.

Syntax

vpn ike -q

vpn ike -s

Example

```

> vpn ike -q
IKE Memory Status and Leakage List

# of free L-Buffer=95, minimum=94, leak=1
# of free M-Buffer=529, minimum=529 leak=3
# of free S-Buffer=1199, minimum=1198, leak=1
# of free Msgid-Buffer=1024, minimum=1024

```

Telnet Command: vpn Multicast

This command allows users to pass or block the multi-cast packet via VPN.

Syntax

vpn Multicast set <H2I/L2I> <index> <Block/Pass>

Syntax Description

Parameter	Description
<H2I/L2I>	H2I means Host to LAN (Remote Access User Accounts). L2I means LAN-to-LAN Profile.
<index>	The index number (1 to 500) of the profile.
<Block/Pass>	Set Block/Pass the Multicast Packets. The default is Block.

Example

```

> vpn Multicast set L2I 1 Pass
% Lan to Lan Profile Index [1] :
% Status Block/Pass: [PASS]

```

Telnet Command: vpn pass2nd

This command allows users to determine if the packets coming from the second subnet passing through current used VPN tunnel.

Syntax

vpn pass2nd on

vpn pass2nd off

Syntax Description

Parameter	Description
<i>on/off</i>	on - the packets can pass through NAT. off - the packets cannot pass through NAT.

Example

```
> vpn pass2nd on
% 2nd subnet is allowed to pass VPN tunnel!
```

Telnet Command: vpn pass2nat

This command allows users to determine if the packets passing through by NAT or not when the VPN tunnel disconnects.

Syntax

vpn pass2nat *on*

vpn pass2nat *off*

Syntax Description

Parameter	Description
<i>on/off</i>	on - the packets can pass through NAT. off - the packets cannot pass through NAT.

Example

```
> vpn pass2nat on
% Packets would go through by NAT when VPN disconnect!!
```

Telnet Command: vpn sameSubnet

This command allows users to build VPN between clients via virtual subnet.

Syntax

vpn sameSubnet *-i <index> -e <subnet> -I <Virtual Subnet> -o <add/del>*

vpn sameSubnet *-i <value>*

vpn sameSubnet *-i <value> -E <0/1>*

vpn sameSubnet *-i <value> -e <value>*

vpn sameSubnet *-I <Virtual Subnet>*

vpn sameSubnet *-o <add/del>*

vpn sameSubnet *-v*

vpn sameSubnet *-m <value>*

Syntax Description

Parameter	Description
<i>-i <value></i>	Specify the index number of VPN profile.
<i>-i <value> -E <0/1></i>	Enable or disable the IPsec with the same subnet.

	1 - enable. 0 - disable.
<i>-i <value> -e <value></i>	Translate specified LAN to virtual subnet. 1 - LAN1 2 - LAN2 3 - LAN3 ...
<i>-i <value> -I <Virtual Subnet></i>	Set the virtual subnet (e.g., 172.16.3.250).
<i>-i <value> -o <add/del></i>	Set the operation (add or delete) for the VPN profile.
<i>-v</i>	Display current status of virtual subnet.
<i>-m <value></i>	Set the translated type. <value> - 1 means Whole Subnet; 2 means Specific IP.

Example

```

> vpn sameSubnet -i 1 -e 1 -I 10.10.10.0 -o add
Add entry Success!!
> vpn sameSubnet -v
IPsec with the same subnet:
VPN profile 201 enable,
  Whole Subnet:
IPsec with the same subnet:
VPN profile 203 enable,
  Whole Subnet:
>

```

Telnet Command: vpn ovpn

This command allows users to configure general settings for OpenVPN.

Syntax

```

vpn ovpn mode <0/1>
vpn ovpn show
vpn ovpn udp_mode <0/1>
vpn ovpn tcp_mode <0/1>
vpn ovpn udp_port <1-65535>
vpn ovpn tcp_port <1-65535>
vpn ovpn cert <0/1>
vpn ovpn replay <0/1>
vpn ovpn certmode <0/1/2>
vpn openvpn hmacmode <0/1/2>
vpn ovpn ca <0/1/2/3>
vpn ovpn tlsauth_del <1/2/3>

```

Syntax Description

Parameter	Description
-----------	-------------

<i>mode</i> <0/1>	Enable (1) or disable (0) the OpenVPN function.
<i>show</i>	Display the OpenVPN setting status.
<i>udp_mode</i> <0/1>	Enable (1) or disable (0) the UDP mode.
<i>tcp_mode</i> <0/1>	Enable (1) or disable (0) the TCP mode.
<i>udp_port</i> <1-65535>	Set the UDP port number.
<i>tcp_port</i> <1-65535>	Set the TCP port number.
<i>cert</i> <0/1>	Enable (1) or disable (0) the certificate authentication.
<i>replay</i> <0/1>	Enable (1) or disable (0) the replay option.
<i>certmode</i> <0/1/2>	Set the Cipher Algorithm Mode. 0 - AES128 1 - AES256 2 - None
<i>hmacmode</i> <0/1/2>	Set the Cipher HMAC mode. 0 - SHA1 1 - SHA256 2 - None
<i>ca</i> <0/1/2/3>	Set the Trust CA certificate.
<i>tlsauth_del</i> <1/2/3>	Delete the first, second or the third TLS-auth key.

Example

```

> vpn ovpn mode 1
Enable openvpn
> vpn ovpn show

Openvpn: Enable
support UDP: Enable
UDP port: 1194
support TCP: Enable
TCP port: 1194
Use certificate authentication: Enable
replay option: Enable
Cipher Algorithm: AES256
HMAC Algorithm: SHA256
Certificate uid: 65535
Trust CA uid: 13
>

```

Telnet Command: vpn dial_out

This command allows users to terminate the VPN connection.

Syntax

```
vpn dial_out dial <index>
```

Syntax Description

Parameter	Description
<index>	It means to terminate specified vpn profile. index - It means 1, 2, 3, 4....

Example

```
> vpn dial_out dial 1
Dialup L2L success
>
```

Telnet Command: vpn mirror

This command allows users to

Syntax

vpn mirror <l2l/h2l> <index>

Syntax Description

Parameter	Description
<l2l/h2l>	l2l - LAN to LAN h2l - Host to LAN
<index>	It means to mirror specified vpn profile. index - It means 1, 2, 3, 4.....

Example

```
> vpn mirror l2l 1
>
```

Telnet Command: vpn fromlan

This command allows a client access a private LAN for getting the required resources.

Syntax

vpn fromlan status

vpn fromlan enable/disable

vpn fromlan add/remove <lanx>

Syntax Description

Parameter	Description
status	It means to display current status of VPN from LAN.
enable/disable	It means to enable or disable the function of VPN from LAN.
add/remove lanx	It means to add or remove specified LAN interface. lanx - x means 2, 3, 4.....

Example

```
> vpn fromlan enable
vpn fromlan status : enable
from lan :
>
```

Telnet Command: vpn isolate

This command let the VPN not communicate with each other.

Syntax

vpn isolate <on/off>

Example

```
> vpn isolate on
>
```

Telnet Command: vpn mfa

This command allows VPN users to bypass 2FA for a certain period of time if they have previously passed the 2FA authentication from the same IP address.

Syntax

vpn mfa bypass 10H

Syntax Description

Parameter	Description
bypass 10H	10H stands for 10 Hours, while 2D stands for 2 Days. Time Range: 0H ~ 31D (0H for Disabled)

Example

```
> vpn mfa bypass 10H
VPN 2FA will valid in 10 Hour(s).
```

Telnet Command: wan ppp_mru

This command allows users to adjust the size of PPP LCP MRU. It is used for specific network.

Syntax

wan ppp_mru <WAN interface number> <MRU size>

Syntax Description

Parameter	Description
<WAN interface number>	Type a number to represent the physical interface. For Vigor130, the number is 1 (which means WAN1).
<MRU size>	It means the number of PPP LCP MRU. The available range is from 1400 to 1600.

Example

```
>wan ppp_mru 1 ?
% Now: 1492

> wan ppp_mru 1 1490
>
> wan ppp_mru 1 ?
% Now: 1490

> wan ppp_mru 1 1492
> wan ppp_mru 1 ?
% Now: 1492
```

Telnet Command: wan mtu / mtu2

This command allows users to adjust the size of MTU for WAN.

Syntax

`wan mtu <value>`

`wan mtu2 <value>`

Syntax Description

Parameter	Description
<i>value</i>	It means the number of MTU for PPP. The available range is from 1000 to 1500. For Static IP/DHCP, the maximum number will be 1500. For PPPoE, the maximum number will be 1492. For PPTP/L2TP, the maximum number will be 1460.

Example

```
> wan mtu 1100
> wan mtu ?
Static IP/DHCP (Max MSS: 1500)
PPPoE(Max MSS: 1492)
PPTP/L2TP(Max MSS: 1460)
% wan ppp_mss <MSS size: 1000 ~ 1500>
% Now: 1100
```

Telnet Command: wan dns

This command allows users to configure primary and / or secondary DNS server.

Syntax

`wan dns <wan_no><dns_select><ipv4_addr>`

Syntax Description

Parameter	Description
<i>wan_no</i>	Select WAN interface (1 to 10). 1:WAN1 2:WAN2 3:WAN3 4:WAN4 5:WAN5 6:WAN6 7:WAN7 8:WAN8 9:WAN9 10:WAN10
<i>dns_select</i>	Specify primary and / or secondary DNS server. pri - It means primary DNS server. sec - It means secondary DNS server.
<i>ipv4_addr</i>	Enter the IP address of DNS server.

Example

```
> wan dns 1 pri 168.95.1.1
% Set WAN1 primary DNS done.
% Now: 168.95.1.1
```

Telnet Command: wan DF_check

This command allows you to enable or disable the function of DF (Don't fragment)

Syntax

wan DF_check <on/off>

Syntax Description

Parameter	Description
<i>on/off</i>	It means to enable or disable DF.

Example

```
> wan DF_check on
%DF bit check enable!
```

Telnet Command: wan disable

This command allows you to disable WAN connection.

Example

```
> wan disable WAN
%WAN disabled.
```

Telnet Command: wan enable

This command allows you to disable wan connection.

Example

```
> wan enable WAN
%WAN1 enabled.
```

Telnet Command: wan forward

This command allows you to enable or disable the function of WAN forwarding. The packets are allowed to be transmitted between different WANs.

Syntax

wan forward <on/off>

Syntax Description

Parameter	Description
<i><on/off></i>	It means to enable or disable WAN forward.

Example

```

> wan forward ?
%WAN forwarding is Disable!

> wan forward on
%WAN forwarding is enable!

```

Telnet Command: wan status

This command allows you to display the status of WAN connection, including connection mode, TX/RX packets, DNS settings and IP address.

Example

```

> wan status
BWAN1: Offline, stall=N
Mode: DHCP Client, Up Time=00:00:00
IP=---, GW IP=---
TX Packets=0, TX Rate(bps)=0, RX Packets=0, RX Rate(bps)=0
Primary DNS=0.0.0.0, Secondary DNS=0.0.0.0

BWAN2: Offline, stall=N
Mode: ---, Up Time=00:00:00
IP=---, GW IP=---
TX Packets=0, TX Rate(bps)=0, RX Packets=0, RX Rate(bps)=0
Primary DNS=0.0.0.0, Secondary DNS=0.0.0.0

BWAN3: Offline, stall=Y
Mode: PPPoE, Up Time=00:00:00
IP=---, GW IP=---
TX Packets=72581, TX Rate(bps)=0, RX Packets=112651, RX Rate(bps)=0
Primary DNS=0.0.0.0, Secondary DNS=0.0.0.0

BWAN4: Offline, stall=N
Mode: ---, Up Time=00:00:00
IP=---, GW IP=---
TX Packets=0, TX Rate(bps)=0, RX Packets=0, RX Rate(bps)=0
Primary DNS=0.0.0.0, Secondary DNS=0.0.0.0

BWAN5: Online, stall=N
...

```

Telnet Command: wan detect

This command allows you to Ping a specified IP to detect the WAN connection (static IP or PPPoE mode).

Syntax

```

wan detect <wan1/wan2/...> <on/off/strict/always_on>
wan detect <wan1> <off> -t <time>
wan detect <wan1> <off> -i <Interval>
wan detect <wan1/wan2/...> target <ip addr>
wan detect <wan1/wan2/...> target2 <ip addr>
wan detect <wan1/wan2/...> target_gw <1/0>

```

wan detect <wan1/wan2/...> ttl <value>
 wan detect <wan1/wan2/...> interval <interval>
 wan detect <wan1/wan2/...> retry <retry>
 wan detect status

Syntax Description

Parameter	Description
<wan1/wan2/...> <on/off/strict/always_on>	On - It means to enable ping detection. The IP address of the target shall be set. Off - It means to enable ARP detection (default). strict - Enable Strict ARP detection. always_on - disable link detect, always connected(only support static IP)
<wan1> <off> -t <time>	Set the time (0 to 256).
<wan1> <off> -i <Interval>	Set the time interval (0 to time value).
<wan1/wan2/...> target <ip addr>	Set the ping target. <ip addr> : It means the IP address used for detection. Type an IP address in this field.
<wan1/wan2/...> target2 <ip addr>	Set the secondary ping target. <ip addr>: It means the IP address used for detection. Type an IP address in this field.
<wan1/wan2/...> target_gw <1/0>	Set whether to use gateway as ping target. (1: yes 0: no)
<wan1/wan2/...> ttl <value>	It means to set the ping TTL value (work as trace route) If you do not set any value for ttl here or just type 0 here, the system will use default setting (255) as the ttl value.
<wan1/wan2/...> interval <interval>	Set the interval between each ping operation. Available setting is between 1 and 3600. The unit is second. <interval>: Type a value.
<wan1/wan2/...>retry <retry>	Set how many ping operations are retried before the Router judges that the WAN connection is disconnected. Available setting is between 1 and 255. The unit is times. <retry> : Type a number.
status	It means to show the current status.

Example

```
> wan detect status
WAN1: arp detect, send time=30, Interval = 5
WAN2: arp detect, send time=30, Interval = 5
WAN3: arp detect, send time=30, Interval = 5
WAN4: arp detect, send time=30, Interval = 5
WAN5: arp detect, send time=30, Interval = 5
WAN6: arp detect, send time=30, Interval = 5
WAN7: arp detect, send time=30, Interval = 5
WAN8: arp detect, send time=30, Interval = 5
WAN9: always on
WAN23: arp detect, send time=30, Interval = 5
...
WAN52: arp detect, send time=30, Interval = 5
```

```

> wan detect wan1 target 192.168.1.78
Set OK

> wan detect wan1 on
Set OK

> wan detect status
WAN1: on, Target=192.168.1.78, TTL=255
WAN2: off
WAN3: off
WAN4: off
WAN5: off
...

```

Telnet Command: wan lb

This command allows you to Enable/Disable for each WAN to join auto load balance member.

Syntax

`wan lb <wan1/wan2/...> on`

`wan lb <wan1/wan2/...> off`

`wan lb <ip/session>`

`wan lb status`

Syntax Description

Parameter	Description
<code>wan1/wan2/...</code>	Specify which WAN will be applied with load balance.
<code>on</code>	Make WAN interface as the member of load balance.
<code>off</code>	Cancel WAN interface as the member of load balance.
<code><ip/session></code>	Set the load balance mode to IP(default) or session based.
<code>status</code>	Show the current status.

Example

```

> wan lb ip 192.168.2.25
Set OK

> wan lb status

WAN1: on
WAN2: on
WAN3: on
WAN4: on
WAN5: on
WAN6: on
WAN7: on
...

```

Telnet Command: wan lbel

This command allows you to define protocol, port and name for the traffic not to be applied with load balance.

Syntax

wan lbel <idx> <enable> <protocol> <ip type> <obj_grp idx> <port> <port_end> <comment>
wan lbel status <idx>

Syntax Description

Parameter	Description
<i>idx</i>	Enter the index number (1 to 32) for the exception list.
<i>enable</i>	Enter 1 (enable) or 0 (disable) the selected profile.
<i>protocol</i>	<protocol>: Enter TCP, UDP, all. "All" means "TCP+UDP".
<i>ip type</i>	Set the IP type (0, 1 or 2) for the selected profile. 0: Any 1: IP object 2: IP group
<i>obj_grp idx</i>	Enter the index number (1 to 32 for IP group; 1 to 500 for IP object). If it is set with "0", then the IP type will be set as "Any".
<i>port</i>	Enter a number (0 to 65535) as starting port. If it is set with "0", then the port range (1 to 65535) will not be applied with load balance.
<i>port_end</i>	Enter a number (0 to 65535) as ending port (must be greater than starting port).
<i>comment</i>	Enter a string (less than 11 characters) as a comment.

Example

```
> wan lbel 1 1 tcp 0 1 0 300 testforload
> wan lbel status 1
list[1] status:enable, protocol:tcp, IP type:any, IP idx:0,
port:0~300, comment:testforload
list[2] status:enable, protocol:udp, IP type:any, IP idx:0,
port:19302~19302, comment:Google STUN
list[3] status:enable, protocol:tcp+udp, IP type:any, IP idx:0,
port:5060~5060, comment:SIP
list[4] status:disable, protocol:tcp, IP type:any, IP idx:0,
port:80~80, comment:HTTP
list[5] status:disable, protocol:tcp, IP type:any, IP idx:0,
port:443~443, comment:SSL
list[6] status:disable, protocol:tcp+udp, IP type:any, IP idx:0,
port:0~0, comment:
list[7] status:disable, protocol:tcp+udp, IP type:any, IP idx:0,
port:0~0, comment:
list[8] status:disable, protocol:tcp+udp, IP type:any, IP idx:0,
port:0~0, comment:
list[9] status:disable, protocol:tcp+udp, IP type:any, IP idx:0,
port:0~0, comment:
list[10] status:disable, protocol:tcp+udp, IP type:any, IP idx:0,
port:0~0, comment:
list[11] status:disable, protocol:tcp+udp, IP type:any, IP idx:0,
port:0~0, comment:
list[12] status:disable, protocol:tcp+udp, IP type:any, IP idx:0,
port:0~0, comment:
list[13] status:disable, protocol:tcp+udp, IP type:any, IP idx:0,
```

```

port:0~0, comment:
  list[14] status:disable, protocol:tcp+udp, IP type:any, IP idx:0,
port:0~0, comment:
  list[15] status:disable, protocol:tcp+udp, IP type:any, IP idx:0,
port:0~0, comment:
  list[16] status:disable, protocol:tcp+udp, IP type:any, IP idx:0,
port:0~0, comment:
  list[17] status:disable, protocol:tcp+udp, IP type:any, IP idx:0,
port:0~0, comment:
  list[18] status:disable, protocol:tcp+udp, IP type:any, IP idx:0,
port:0~0, comment:
  list[19] status:disable, protocol:tcp+udp, IP type:any, IP idx:0,
port:0~0, comment:
  list[20] status:disable, protocol:tcp+udp, IP type:any, IP idx:0,
port:0~0, comment:
  list[21] status:disable, protocol:tcp+udp, IP type:any, IP idx:0,
port:0~0, comment:
  list[22] status:disable, protocol:tcp+udp, IP type:any, IP idx:0,
port:0~0, comment:
  list[23] status:disable, protocol:tcp+udp, IP type:any, IP idx:0,
port:0~0, comment:

  list[24] status:disable, protocol:tcp+udp, IP type:any, IP idx:0,
port:0~0, comment:
--- MORE ---  ['q': Quit, 'Enter': New Lines, 'Space Bar': Next Page]
---
>

```

Telnet Command: wan mvlan

This command allows you to configure multi-VLAN for WAN and LAN. It supports pure bridge mode (modem mode) between Ethernet WAN and LAN port 2~4.

Syntax

```
wan mvlan <pvc_no/status/save/enable/disable> <on/off/clear/tag tag_no> <service
type/vlan priority> <px ... >
```

Syntax Description

Parameter	Description
<i>pvc_no</i>	It means index number of PVC. There are 8 PVC, 0(Channel-1) to 7(Channel-7) allowed to be configured. However, only 2 to 7 are available for configuration.
<i>status</i>	It means to display the whole Bridge status.
<i>save</i>	It means to save the configuration into flash of Vigor router.
<i>enable/disable</i>	It means to enable/disable the Multi-VLAN function.
<i>on/off</i>	It means to turn on/off bridge mode for the specific channel.
<i>clear</i>	It means to turn off/clear the port.
<i>tag tag_no</i>	It means to tag a number for the VLAN. -1: No need to add tag number. 1-4095: Available setting numbers used as tagged number.
<i>service type</i>	It means to specify the service type for VLAN. 0: Normal.

	1: IGMP.
<i>vlan priority</i>	It means to specify the priority for the VALN setting. Range is from 0 to 7.
<i>px</i>	It means LAN port. Available setting number is from 2 to 4. Port number 1 is locked for NAT usage.

Example

PVC 7 will map to LAN port 2/3/4 in bridge mode; service type is Normal. No tag added.

```
> wan mvlan 7 on p2 p3 p4
PVC Bridge p1 p2 p3 p4 p5 p6 p7 p8 p9 p10 p11 p12 Se
rvice Type Tag Priority
-----
7 ON 0 0 1 1 0 0 0 0 0 0 0 0 N
ormal 0(OFF) 0
>
```

Telnet Command: wan multifno

This command allows you to specify a channel (in Multi-PVC/VLAN) to make bridge connection to a specified WAN interface.

Syntax

`wan multifno <channel #><WAN interface #>`

`wan multifno status`

Syntax Description

Parameter	Description
<code><channel #><WAN interface #></code>	<code><channel #></code> - There are several channels including VLAN and PVC. Available settings are: 13=Channel 13 14=Channel 14 ... 52=Channel 52 <code>WAN interface #</code> - Enter a number to indicate the WAN interface. 1=WAN1, 2=WAN2
<code>status</code>	It means to display current bridge status.

Example

```
> wan multifno 13 1
% Configured channel 13 uplink to WAN1
> wan multifno status
% Channel 13 uplink ifno: 3
% Channel 14 uplink ifno: 3
% Channel 15 uplink ifno: 3
% Channel 16 uplink ifno: 3
% Channel 17 uplink ifno: 3
...
```

```
>
```

Telnet Command: wan vlan

This command allows you to tag packets on WAN VLAN with specified number.

Syntax

```
wan vlan wan <#> tag <value>
```

```
wan vlan wan <#> <enable/disable>
```

```
wan vlan wan <#> pri <value>
```

```
wan vlan stat
```

Syntax Description

Parameter	Description
<i>wan <#></i>	Specify which WAN interface will be tagged.
<i>tag <value></i>	Type a number for tagging on WAN interface.
<i>enable/disable</i>	Enable: Specified WAN interface will be tagged. Disable: Disable the function of tagging on WAN interface.
<i>pri <value></i>	Set the priority of the WAN interface. <value>: 0 to 7
<i>stat</i>	Display current VLAN status.

Example

```
> wan vlan wan 1 pri 6
> Set priority to 6 for WAN1
> wan vlan stat
% Interface      Pri      Tag      Enabled
% =====
% WAN1           6        0
% WAN2           0        0
% WAN3           0        0
% WAN4           0        0
% WAN5           0        0
...

```

Telnet Command: wan budget

This command allows you determine the data *traffic volume* for each WAN interface respectively to prevent from overcharges for data transmission by the ISP.

Syntax

```

wan budget wan <#> rdate <day><hour>
wan budget wan <#> <enable/disable>
wan budget wan <#> thres <budget limit (MB)>
wan budget wan <#> gthres <budget limit (GB)>
wan budget wan <#> mode <monthly/periodic/none>
wan budget wan <#> psday <th day in periodic>
wan budget wan <#> custom_mode <0/1>
wan budget wan <#> custom_mode_reset_hour <hour>
wan budget wan <#> action <action bitmap>
wan budget status
  
```

Syntax Description

Parameter	Description
<i>wan <#> rdate <day><hour></i>	<p>wan <#>: Specify the WAN interface (1 to 12).</p> <p>rdate <day><hour>: Specify the WAN budget refresh time.</p> <p>day - Available settings are from 1 to 30.</p> <p>hour - Available settings are from 1 to 23.</p> <p>E.g., wan budget wan 1 rdate 5 10</p> <p>If monthly mode is selected: WAN budget will be refreshed on 5th day at 10:00 in each month.</p> <p>If periodic mode is selected: WAN budget will be refreshed every 5 days and 10 hours.</p>
<i><enable/disable></i>	<p>enable - Enable the function of wan budget.</p> <p>disable - Disable the function of wan budget.</p>
<i>thres <budget limit (MB)></i>	Specify the maximum value for WAN budget limit. (Unit: MB) budget limit - Type a number.
<i>gthres <budget limit (GB)></i>	Specify the maximum value of wan budget limit. (Unit: GB) budget limit - Type a number.
<i>mode <monthly/periodic/none></i>	Specify the calculation mode (monthly, periodically, or none) for WAN budget.
<i>psday <th day in periodic></i>	<p>It is used only when mode is set with "periodic". Specify the order of "today" in the cycle.</p> <p>E.g., wan budget wan 5 psday → It means "today" is the 5th day in the billing cycle.</p>
<i>custom_mode <0/1></i>	<p>Set the custom mode (cycle in hours or in days).</p> <p>0: cycle_in_hours</p> <p>1: cycle_in_days</p>
<i>custom_mode_reset_hour <hour></i>	<p>Set the reset hour value.</p> <p>hour: Enter 1 to 23.</p>
<i>action <action bitmap></i>	<p>Determine the action to be performed when it reaches the WAN budget limit.</p> <p><i>action bitmap</i> - Type a total number of actions to be executed. Different numbers represent different actions.</p> <p>1: shutdown wan</p> <p>2: send mail alert</p> <p>4: send sms alert</p> <p>For example, if you type "5" (5=1+4), the system will send SMS alert</p>

	when WAN shutdown is detected.
<i>status</i>	Display current configuration status of WAN budget.

Example

```
> wan budget wan 1 action 5
% WAN 1 budget action set to 5
> wan budget wan 1 gthres 10
% WAN 1 budget limit set to 10 GB
```

Telnet Command: wan detect_mtu

This command allows you to run a WAN MTU Discovery. The user can specify an IPv4 target to ping and find the suitable MTU size of the WAN interface.

Syntax

wan detect_mtu *-i* <Host/IP address> *-s* <mtu_size> *-d* <decrease size> *-w* <1: WAN1 ,2: WAN2, ...> *-c* <count>

Syntax Description

Parameter	Description
<i>-i</i> <Host/IP address>	Specify the IPv4 target to detect. If can be an IPv4 address or domain name. Host/IP address: Enter the IP address/domain name of the target.
<i>-s</i> <mtu_size>	Set the MTU size base for Discovery. mtu_size: Available setting is 1000 ~ 1500.
<i>-d</i> <decrease size>	Set the MTU size to decrease between detections. decrease size: Available setting is 1 ~ 100.
<i>-w</i> <number>	Specify the WAN interface. number: Enter the number of WAN interface. 1: WAN1 2: WAN2....and etc.
<i>-c</i> <count>	Set the maximum times of ping failure during a Discovery. count: Available settings are 1 ~ 10. Default value is 3.

Example

```
> wan detect_mtu -w 1 -i 8.8.8.8 -s 1500 -d 30 -c 10
detecting mtu size:1500!!!
mtu size:1470!!!
```

Telnet Command: wan detect_mtu6

This command allows you to run a WAN MTU Discovery. The user can specify an IPv6 target to ping and find the suitable MTU size of the WAN interface.

Syntax

wan detect_mtu6 *-i* <Host/IP address> *-s* <mtu_size> *-w* <number>

Syntax Description

Parameter	Description
<i>-i</i> <Host/IP address>	Specify the IPv6 target to detect. If can be an IPv6 address or domain name.

	Host/IP address: Enter the IP address/domain name of the target.
-s <mtu_size>	Specify the size of MTU. mtu_size: Available setting is 1280 ~ 1500.
-w <number>	Specify the WAN interface number: Enter the number of WAN interface. 1: WAN1 2: WAN2....and etc.

Example

```
> wan detect_mtu6 -w 2 -i 2404:6800:4008:c06::5e -s 1500
>
```

Telnet Command: wan failover

This command is used to configure failover WAN.

Syntax

wan failover off <index>

wan failover on <1><2><3><4><5><6>

wan failover show <index>

wan failover newlb <index><arg>

Syntax Description

Parameter	Description
<i>failover off</i> <index>	Set specified WAN interface to always on. index - Ranges from 1 to 12.
<i>failover on</i> <1><2><3><4><5><6>	There are six fields which represent different options. Field 1 - Specify WAN interface as failover WAN by typing 1 to 7. Field 2 - Enable / disable the action for the failover WAN. Such action is "Active When selected WAN [disconnect/reached traffic threshold]". 0 - Disable 1 - Enable Field 3 - Enable / disable the action for the failover WAN. Such action is "Active When [any/all] of selected WAN disconnect or reached traffic threshold". 0 - Disable 1 - Enable Field 4 - Specify main WAN by typing 1 to 7. The main WAN will be set to always on. Field 5 - Specify traffic threshold [Download threshold(Kbps)]. Field 6 - Specify traffic threshold [Upload threshold (Kbps)]. For example, WAN 2 will be set as failover, and will be active when any of selected WANs has reached traffic threshold. WAN 4 is the selected WAN. Download threshold : 50 Kbps; Upload threshold : 20 Kbps. You can type as follows: <i>wan failover on 2 1 0 4 50 20</i>
<i>show</i> <index>	Display parameters settings for WAN interface. index - Ranges from 1 to 12.
<i>newlb</i> <index><arg>	Set the latency, jitter, packet loss threshold of the WAN interface. index - 1 to 12

```

arg - lists as follows:
-a [all] : 0=any meet, 1=all meet.
-u [check] : 0=n/a, 1=check upload.
-d [check] : 0=n/a, 1=check download.
-l [check] : 0=n/a, 1=check latency.
-j [check] : 0=n/a, 1=check jitter.
-p[check] : 0=n/a, 1=check packet loss.
-m[value] : upload threshold value.
-n [value] : download threshold value.
-x [value] : latency threshold value.
-y [value] : jitter threshold value.
-z [value] : packet loss threshold value.

```

Example

```

> wan failover on 2 1 0 4 50 20
> wan failover show 2
wan2 Active Mode : Failover
Active when : Any of the selected WANs reached the Traffic
Threshold, any followed meet:
>

```

Telnet Command: hspportal setup

This command is used to configure a profile (Hotspot Web Portal) with specified URL for accessing into or display a message when a wireless/LAN user connects to Internet through this router.

Syntax

```
hspportal setup -p <profile> <-l <lan>> <-s <ssid>> ...
```

```
hspportal setup -p <profile> -c
```

Syntax Description

Parameter	Description
-p	Indicate available profile to be configured. Number of profile: 1 / 2 / 3 / 4.
-l	Apply to LAN interfaces. E.g., apply LAN1 and LAN2: -l 1, 2.
-m	Select login mode. 0:skip 1:click 2:social 3:pin 4:social or pin
-f<0/1>	Configure facebook login. 0: disable. 1: enable.
-g<0/1>	Configure google login. 0: disable. 1: enable.
-h<0/1>	Enable HTTPS redirection.

	0: disable. 1: enable.
-v<0/1>	Enable portal detection. 0: disable. 1: enable.
-i<string>	Configure APP ID. For example, to configure facebook APP id, you can type: >hsportal -p 1 -f -i this_is_app_id Profile 1 set facebook login disabled ... [OK]
-k<string>	Configure app key. For example, to configure google APP key, you can type: > hsportal -p 1 -g -i this_is_app_key Profile 1 set google login disabled ... [OK]
-r<0/1/2>	Configure landing page mode. 0: fixed URL. 1: user request. 2: bulletin. e.g. > hsportal -p 1 -r 0 Profile 1 set landing page mode 0 ... [OK]
-e	Enable the specified profile.
-d	Disable the specified profile.
-c<1/2/3/4>	Reset the specified profile. Number of profile: 1 /2 /3 / 4.
-o	Clear profiles for all clients.

Example

```

> hsportal setup -p 1 -c
Reset profile 1 ... [OK]
> hsportal setup -p 1 -r 0
Profile 1 set landing page mode 0 ... [OK]
> hsportal setup -p 2 -g 1 -k app_key_google
Profile 2 set google login enabled ... [OK]
Profile 2 set API KEY ... [OK]
>

```

Telnet Command: hsportal info

This command is used to enable /disable database, notification, specify object profile for information related to hotspot web portal users.

Syntax

hsportal info -e <0/1>

hsportal info -c

hsportal info -n <0/1>

hsportal info -a <0/1>

hsportal info -m <1-10>

hsportal info -s <1-10>

Syntax Description

Parameter	Description
<code>-e <0/1></code>	Enable database to record information. 0 - disable 1 - enable
<code>-c</code>	Clear user information database.
<code>-n <0/1></code>	Enable notification for user information. 0 - disable 1 - enable
<code>-a <0/1></code>	Enable auto backup and start a new record for user information. 0 - disable 1 - enable
<code>-m <1-10></code>	Set email notification object. 1-10- Index number of object profile.
<code>-s <1-10></code>	Set SMS notification object. 1-10- Index number of object profile.

Example

```
> hsportal info -e 1
Enabled database to record information ... [OK]
> hsportal info -a 1
Enabled auto backup and start a new record for user information ...
[OK]
>
```

Telnet Command: hsportal level

This command allows the user to configure bandwidth and sessions quota which is only applicable to the web portal clients.

Syntax

`hsportal level -p <index> [-e <enable>] [-t <mins>] ...`

Syntax Description

Parameter	Description
<code>-p <index></code>	It means to specify (add) a quota policy profile. <index>: Enter the index number (1 to 20) of the quota policy profile.
<code>-e <0/1></code>	It means to enable or disable the quota policy profile. 0: disable. 1: enable.
<code>-t <value></code>	It means to set expired time for quota policy. <value>: Enter a number (unit:minutes).
<code>-i <0/1> -o <value></code>	It means to enable or disable the function of idle timeout 0: disable. 1: enable. If enabled, -o <value>: Set the idle timeout (unit:minutes) if idle timeout is enabled.

	For example: <code>hsportal level -p 1 -e 1 -i 1 -o 300</code>
<code>-d <value></code>	It means to set the maximum number of devices that can be connected to the network using the same account. <value>: Enter a number (0 to 100). "0" means unlimited. For example: <code>hsportal level -p 1 -e 1 -d 0</code>
<code>-b <0/1></code>	It means to enable or disable the function of bandwidth limit. 0: disable. 1: enable.
<code>-ru <0/1></code>	It means to specify the bandwidth limit download unit. 0: kbps 1: mbps
<code>-tu <0/1></code>	It means to specify the bandwidth limit upload unit. 0: kbps. 1: mbps.
<code>-s <0/1></code>	It means to enable or disable the session limit. 0:disable. 1:enable.
<code>-n <value></code>	It means to set a maximum session limit. <value>: Enter a value (0 to 6000). For example: <code>hsportal level -p 1 -s 1 -n</code>
<code>-U <kbps/mbps></code>	It means to specify the bandwidth upload limit. kbps mbps
<code>-D <kbps/mbps></code>	It means to specify the bandwidth download limit. kbps mbps
<code>-c <index></code>	It means to delete a quota policy profile. <index>: Enter the index number (1 to 20) of the quota policy profile.
<code>-r <0/1></code>	It means to enable or disable the function of reconnection time restriction. 0:disable. 1:enable.
<code>-f <value></code>	It means to set a period of time to block the same user reconnecting to the network. <value>: Enter a number (1 to 1439 minutes). For example: <code>hsportal level -p 1 -e 1 -r 1 -f 300</code>
<code>-g <value></code>	It means to set a reconnection time to block the same user from reconnecting before the set time. <value>: Enter the hour (01 to 23) and the minutes (0-59) (unit: minutes). For example: <code>hsportal level -p 1 -e 1 -r 1 -f 23:15</code> (The same user can reconnect after 23:15 every day)

Example

```
> hsportal level -p 1 -e 1 -r 1 -f 30000
>
```

Telnet Command: hportal pin_gen

This command is for future use.

Telnet Command: radius internal

This command allows you to configure detailed settings for internal RADIUS server and client.

Syntax

radius enable <0/1>

radius authport <port number>

radius set_auth_method <method idx>

radius client add <idx> -i <address> -m <mask> -p <prefix> -l <length> -s <secret>

radius client del <idx>

radius show

radius enable_dot1x <0/1>

radius set_dot1x_method -e <method_idx>

radius set_dot1x_method -d <method_idx>

Syntax Description

Parameter	Description
<i>enable</i> <0/1>	Enable (1) or disable (0) the RADIUS server.
<i>authport</i> <port number>	Configure the port number for authentication. Port number: Available range is from 0 to 65535. Default value is "1812".
<i>set_auth_method</i> <method idx>	Specify which method will be used for authentication. Method idx: 0 and 1 0: Only PAP 1: PAP/CHAP/MS-CHAP/MS-CHAPv2
<i>client add</i> <idx> -i <address> -m <mask> -p <prefix> -l <length> -s <secret>	Specify a client to be authenticated by RADIUS server by typing required information as follows: -i <address>: client IPv4 address(domain) -m <mask>: client IPv4 mask -p <prefix>: client IPv6 prefix -l <length>: client IPv6 prefix length -s <secret>: shared secret ex: radius client add 1 -i 192.168.1.1 -m 255.255.255.0 -s 123
<i>client del</i> <idx>	<i>del</i> - Delete related settings for selected client. <i>idx</i> - Specify the index number of client profiles.
<i>show</i>	Display the status of RADIUS server.
<i>enable_dot1x</i> <0/1>	Enable (1) or disable (0) the 802.1X Authentication function of RADIUS Server. Default is disabled.
<i>set_dot1x_method</i> -e <method_idx>	Set a method for 802.1X authentication of RADIUS server. Method idx: 1 to 4. 1: EAP_PEAP/MSCHAPv2 2: EAP_TTLS/PAP 3: EAP_TTLS/MSCHAP 4: EAP_TTLS/MSCHAPv2
<i>set_dot1x_method</i> -d	Delete the method for 802.1X authentication of RADIUS server.

<i><method_idx></i>	Method idx: 1 to 4. 1: EAP_PEAP/MSCHAPv2 2: EAP_TTLS/PAP 3: EAP_TTLS/MSCHAP 4: EAP_TTLS/MSCHAPv2
---------------------------	--

Example

```
> radius client add 1 -i 192.168.1.1 -m 255.255.255.0 -s 123
  Set radius server client OK
>
```

Telnet Command: radius external

This command allows you to configure detailed settings for external RADIUS server.

Syntax

radius external *<options>*...

Syntax Description

Parameter	Description
<i><options></i> ...	The available commands with parameters are listed below. [...] means that you can type in several parameters in one line.
-V	Show current setting.
-v <i><index></i>	Show current setting for certain RADIUS profile. <i><index></i> : Enter the index number of the profile.
-l <i><index></i>	Show the server status log. <i><index></i> : Enter the index number of the profile.
-c " <i><index></i> <i><comment></i> "	Set the comment for certain RADIUS profile. <i><index></i> : Enter the index number of the profile. <i><comment></i> : Enter a string.
-f <i><index></i>	Set the selected profile as the default external RADIUS profile. <i><index></i> : Enter the index number of the profile.
-e " <i><index></i> <i><param></i> "	Enable or disable the external RADIUS profile. <i><index></i> : Enter the index number of the profile. <i><param></i> : 0 or 1. 0 is disable; 1 is enable. ex: -e "2 1" to enable the profile 2
-i " <i><index></i> <i><index2></i> <i><hostname/IP></i> "	Set the hostname or IP address for the selected RADIUS server profile. <i><index></i> : Enter the index number of the profile. <i><index2></i> : 0 or 1. 0 means the primary server; 1 means the secondary server. ex: -i "1 0 192.168.1.1" or -i "2 1 www.google.com"
-p " <i><index></i> <i><index2></i> <i><port_number></i> "	Set the destination port for the selected RADIUS server. <i><index></i> : Enter the index number of the profile. <i><index2></i> : 0 or 1. 0 means the primary server; 1 means the secondary server. <i><port_number></i> : 1 ~ 65535. ex : -p "1 1 1812"
-s " <i><index></i> <i><index2></i> <i><secret></i> "	Set the shared secret for the selected RADIUS server. <i><index></i> : Enter the index number of the profile.

	<p><index2>: 0 or 1. 0 means the primary server; 1 means the secondary server. <secret>: 1 ~ 65535. ex : -s "3 0 123"</p>
-r "<index> <index2> <retry>"	<p>Set the retry number for the selected RADIUS server. <index>: Enter the index number of the profile. <index2>: 0 or 1. 0 means the primary server; 1 means the secondary server. <retry>: 1 to 3. ex : -s "3 0 2"</p>
-a "<index> <param>"	<p>Enable or disable the accounting port for the selected RADIUS server. <index>: Enter the index number of the profile. <param>: 0 or 1. 0 is disable; 1 is enable.</p>
-b "<index> <index2> <port_number>"	<p>Set the accounting port for the selected RADIUS server. <index>: Enter the index number of the profile. <index2>: 0 or 1. 0 means the primary server; 1 means the secondary server. <port_number>: 1 ~ 65535. ex : -b "1 0 1813"</p>
-d "<index> <index2> <port_number>"	<p>Disconnect the message port for the selected RADIUS server. <index>: Enter the index number of the profile. <index2>: 0 or 1. 0 means the primary server; 1 means the secondary server. <port_number>: 1 ~ 65535. ex : -d "1 1 3799"</p>
-u "<index> <index2> <update interval>"	<p>Set the accounting interim interval for the selected RADIUS server. <index>: Enter the index number of the profile. <index2>: 0 or 1. 0 means the primary server; 1 means the secondary server. <port_number>: 10 ~ 1440 (minutes) ex : -u "1 0 10"</p>

Example

```

> radius external -i "1 0 192.168.1.1"
  This setting will take effect after rebooting.
  Please use "sys reboot" command to reboot the router.
> radius external -V
Profile default enable comment
% 1      v
% 2
% 3
% 4

```

Telnet Command: local_8021x

The command is used to configure general settings for Local 802.1X server built in Vigor router.

Syntax

local_8021x enable <0/1>

local_8021x set_localdot1x_method -e <method_idx>

local_8021x set_localdot1x_method -d <method_idx>

local_8021x show

Syntax Description

Parameter	Description
<i>enable</i>	Enable or disable the configuration. 0: disable. 1: enable.
<i>-e <method_idx></i>	Set the authentication method. <method_idx>: 1 to 4, 1: EAP_PEAP/MSCHAPv2 2: EAP_TTLS/PAP 3: EAP_TTLS/MSCHAP 4: EAP_TTLS/MSCHAPv2 e.g., local_8021x set_localdot1x_method-e 1
<i>-d <method_idx></i>	Delete the authentication method. <method_idx>: 1 to 4, 1: EAP_PEAP/MSCHAPv2 2: EAP_TTLS/PAP 3: EAP_TTLS/MSCHAP 4: EAP_TTLS/MSCHAPv2 e.g., local_8021x set_localdot1x_method-d 3
<i>show</i>	Display current settings of local 802.1x server.

Example

```
> local_8021x set_localdot1x_method -e 1
This setting will take effect after rebooting.
Please use "sys reboot" command to reboot the router.
> local_8021x show
% Local 802.1X enable: disable
>
```

Telnet Command: wol

This command allows Administrator to set the white list of WAN IP addresses/Subnets, that the magic packet from these IP addresses/Subnets will be eligible to pass through NAT and wake up the LAN client. You also need to set NAT rule for LAN client.

Syntax

wol up <MAC Address>

wol fromWan <on/off/any>

wol fromWan_Setting <idx> <ip address> <mask>

Syntax Description

Parameter	Description
<MAC Address>	It means the MAC address of the host.
<on/off/any>	It means to enable or disable the function of WOL from WAN. on: enable off: disable

	any: It means any source IP address can pass through NAT and wake up the LAN client. This command will allow the user to choose whether WoL packets can be passed from the Internet to the LAN network from a specific WAN interface.
<i><idx></i> <i><ip address></i> <i><mask></i>	It means the index number (from 1 to 4). These commands will allow the user to configure the LAN clients that the user may wake up from the Internet through the use of the WoL packet. <i>ip address</i> - It means the WAN IP address. <i>mask</i> - It means the mask of the IP address.

Example

```
> wol fromWan: on
% wol fromWan: on
> wol fromWan_Setting 1 192.168.1.45 255.255.255.0
% wol fromWan_Setting 1 192.168.1.45 255.255.255.0
>
```

Telnet Command: user

The command is used to create new user account profiles.

Syntax

user set *<-a/-b/-c/-d/-e/-l/-o/-q/-r/-s/-u>*

user edit *<PROFILE_IDX>*

<-a/-d/-e/-f/-i/-o/-m/-n/-p/-q/-r/-s/-t/-u/-v/-w/-x/-A/-H/-T/-P/-I/-L/-D>

user account *<USER_NAME><-t/-d/-q/-r/-w>*

user setdefault

Syntax Description

Parameter	Description
<i>set</i>	It means to configure general setup for the user management.
<i>edit</i>	It means to modify the selected user profile.
<i>account</i>	It means to set time and data quota for specified user account.
<i>setdefault</i>	It means to reset to factory default settings.
User Set	
<i>-a <Profile idx> <User name><IP_Address></i>	It means to pass an IP Address. Profile idx- type the index number of the selected profile. User name- type the user name that you want it to pass. IP_Address- type the IP address that you want it to pass.
<i>-b <user name></i> <i>-b ip <ip address></i>	Block specifies user or IP address. <i>user name</i> - type the user name that you want to block. <i>ip address</i> -- type the IP address that you want to block.
<i>-c <user name></i> <i>-c all</i>	Clear the user record. <i>user name</i> - type the user name that you want to get clear corresponding record. <i>all</i> - all of the records will be removed.
<i>-d</i>	Enable the User management in Rule-Based mode.
<i>-e</i>	Enable the User management in User-Based mode.

-l all -l user -l ip	Show online user. all - all of the users will be displayed on the screen. user name - type the user name that you want to view on the screen. ip - type the IP address that you want to view on the screen.
-o	It means to show user account information. e.g., -o
-q	It means to trigger the alert tool to do authentication.
-r <user name all>	Remove the user record. user name - type the name of the user profile. all - all of the user profile settings will be removed.
-s	It means to set login service. 0:HTTPS 1:HTTP e.g., -s 1
-u user <user name> -u ip <ip address>	Unblock specifies user or IP address. user name - type the user name that you want to unblock. ip address -- type the IP address that you want to unblock.
User edit	
PROFILE_IDX	Type the index number of the profile that you want to edit.
-a <0/1>	Enable(1) or disable(0) the internal RADIUS.
-d	Disable User profile function.
-e	Enable User profile function.
-f <0/1>	Enable(1) or disable(0) the local 802.1x user.
-i <0-255>	It means to set idle time (from 0 to 255, 0 means unlimited). e.g., -i 60
-o <0-65535>	It means to set auto-logout (from 0 to 65535, 0 means unlimited).
-m <0-2000>	It means to set the maximum (from 0 to 2000) login user number. e.g., -m 200
-n <param>	It means to set a user name for a profile. Param: Enter a string, e.g., -n forttest.
-p <param>	It means to configure user password. Param: Enter a string, e.g., -p 60forttest.
-q <param>	It means to set time quota (0-65535) of the user profile. Param: Enter a value, e.g., -q 200.
-r <param>	It means to set data quota. Param: Enter a value, e.g., -r 1000.
-s <sch_idx1,sch_idx2,sch_idx3 , and sch_idx4>	It means to set schedule index. Available settings are" sch_idx1,sch_idx2,sch_idx3, and sch_idx4.
-t <0/1>	It means to enable /disable time quota limitation for user profile 0:Disable 1:Enable
-u <0/1>	It means to enable /disable data quota limitation for user profile 0:Disable 1:Enable
-v	It means to view user profile(s).

<i>-w <MB/GB></i>	It means to specify the data quota unit (MB/GB). e.g., -w MB
<i>-x <0-3></i>	It means to set external server authentication 0: None 1: LDAP 2: Radius 3: TACAS e.g., -x 2
<i>-l <0-3></i>	It means to set log type. 0:None 1:Login 2:Event 3:All
<i>-P <0/1></i>	It means to enable /disable pop browser tracking window for user profile 0:Disable 1:Enable
<i>-T <0/1></i>	It means to enable /disable authentication by telnet. 0:Disable 1:Enable
<i>-H <0/1></i>	It means to enable /disable authentication by web page. 0:Disable 1:Enable
<i>-A <0/1></i>	It means to enable /disable authentication by alert tool. 0:Disable 1:Enable
<i>-L <index></i>	It means to set active directory / LDAP profiles. Index: Specify the index number (profile_idx1 to profile_idx8) of the profile.
<i>-D</i>	It means to list all active directory / LDAP profiles.
<i>-O <0/1></i>	It means to reset the quota automatically. 0:Disable 1:Enable
<i>-Q <param></i>	It means to set the default time quota. param: Enter a number (1 to 65535).
<i>-R <param></i>	It means to set the default data quota. param: Enter a number (1 to 65535).
<i>-M <param></i>	It means to set the default quota type. 0: when login permission schedule expired. 1: at the start time of schedule.
<i>l <param></i>	It means to specify the default quota schedule index to perform the job at the start time.
<i>-S</i>	It means to display the reset default quota type and the schedule index.
<i>User account</i>	
<i>USER_NAME</i>	It means to type a name of the user account.
<i>-d <0/1></i>	It means to enable /disable data quota limitation for user account. 0:Disable 1:Enable

<code>-q</code>	It means to set account time quota. e.g., <code>-q 200</code>
<code>-r</code>	It means to set account data quota. e.g., <code>-r 1000</code>
<code>-t <0/1></code>	It means to enable /disable time quota limitation for user account. 0:Disable 1:Enable
<code>-w <MB/GB></code>	It means to set data quota unit (MB/GB).
<code>user setdefault</code>	It means to setup all user profiles to the factory default settings.

Example

```
> user account admin -d 1
Enable the [admin] data quota limited
```

Telnet Command: appqos

The command is used to configure QoS for APP.

Syntax

`appqos view`

`appqos enable <0/1>`

`appqos traceable <-v | -e AP_INDEX CLASS | -d AP_INDEX>`

`appqos untraceable <-v | -e AP_INDEX CLASS | -d AP_INDEX>`

Syntax Description

Parameter	Description
<code>view</code>	It means to display current status of APP QoS.
<code>enable <0/1></code>	It means to enable or disable the function of APP QoS.
<code>traceable/ untraceable</code>	The APPs are divided into traceable and untraceable based on their properties.
<code>-v</code>	It means to view the content of all traceable APs. Use "appqos traceable -v" to display all of the traceable APS with spificed index number. Use "appqos untraceable -v" to display all of the untraceable APS with spificed index number.
<code>-e</code>	It menas to enable QoS for application(s) and assign QoS class.
<code>AP_INDEX</code>	Each index number represents one application. Index number: 50, 51, 52, 53, 54, 58, 60, 62, 63, 64, 65, 66, 68 are used for 13 traceabel APPs. Index number: 0-49, 55-59, 61, 67, 69, and 70-123 are used for 125 untraceable AP.
<code>CLASS</code>	Specifies the QoS class of the application, from 1 to 4 1:Class 1, 2:Class 2, 3:Class 3, 4:Other Class
<code>-d</code>	It means to disable QoS for application(s).

Example

```
> appqos enable 1
```

```

APP QoS set to Enable.
> appqos traceable -e 68 2

SSH: ENABLED, QoS Class 2.

```

Telnet Command: nand bad /nand usage

“NAND usage” is used to display NAND Flash usage; “nand bad” is used to display NAND Flash bad blocks.

Syntax

nand bad

nand usage

Example

```

>nand usage
Show NAND Flash Usage:
Partition      Total          Used           Available      Use%
cfg            4194304        7920           4186384        0%
bin_web       33554432       11869493       21684939       35%
cfg-bak       4194304        7920           4186384        0%
bin_web-bak   33554432       11869493       21684939       35%
> nand bad
Show NAND Flash Bad Blocks:
Block  Address          Partition
1020   0x07f80000      unused
1021   0x07fa0000      unused
1022   0x07fc0000      unused
1023   0x07fe0000      unused

```

Telnet Command: apm enable/disable/show/clear/discover/query

The apm command(s) is use to display, remove, discover or query the information of VigorAP registered to Vigor3912.

Syntax

apm enable

apm disable

apm show

apm clear

apm discover

apm query

Syntax Description

Parameter	Description
<i>enable</i>	It means to enable APM function.
<i>disable</i>	It means to disable APM function.
<i>show</i>	It displays current information of APM profile.
<i>clear</i>	It is used to remove all of the APM profile.

<i>discover</i>	It is used to search VigorAP on LAN.
<i>query</i>	It is used to query any VigorAP which has been registered to APM (Central AP Management) in Vigor router. Information related to the registered AP will be send back to Vigor router for updating the web page of Central AP Management.

Example

```
> apm clear
Clear all clients ... done
```

Telnet Command: apm profile

This command allows to configure wireless profiles to be used in Central AP Management.

Syntax

```
apm profile clone <from index><to index><new name>
apm profile del <index>
apm profile reset
apm profile summary
apm profile show <profile index>
apm profile apply <profile index> <client index1 index2 .. index5>
```

Syntax Description

Parameter	Description
<i>clone</i>	It is used to copy the same parameters settings from one profile to another APM profile.
<i>del</i>	It is used to delete a specified APM profile. The default (index #1) should not be deleted.
<i>reset</i>	It is used to reset to factory settings for WLAN profile.
<i>summary</i>	It is used to list all of the APM profiles with required information.
<i>show</i>	It is used to display specified APM profile.
<i>apply</i>	It is used to apply the selected APM profile onto specified VigorAP.
<i>from index</i>	Type an index number in this field. It is the original APM profile to be cloned to other APM profile.
<i>to index</i>	Type an index number in this file. It is the target profile which will clone the parameters settings from an existed APM profile.
<i>new name</i>	Type a name for a new APM profile.
<i>profile index</i>	Enter the index number of existed profile.
<i>client index1/2/3/4/5</i>	It is useful for applying the selected APM profile to the specified VigorAP.

Example

```
> apm profile clone 1 2 forcarrie
(Done)

> apm profile summary
# Name          SSID          Security    ACL    RateCtrl(U/D)
- - - - -
```

0	Default	DrayTek-LAN-A	WPA+WPA2/PSK	x	- / -	-
		DrayTek-LAN-B	WPA+WPA2/PSK	x	- / -	-
1	-	-	-	-	-	-
2	forcarrie	DrayTek	Disable	x	- / -	-
3	-	-	-	-	-	-
4	-	-	-	-	-	-
5	-	-	-	-	-	-
6	-	-	-	-	-	-
7	-	-	-	-	-	-
8	-	-	-	-	-	-
9	-	-	-	-	-	-
10	-	-	-	-	-	-
	...					
	...					
	19					
	>					

Telnet Command: apm cache

This command is used to display or remove the information of registered VigorAP, including MAC address, name, and authentication. Up to 30 entries of registered information can be stored and displayed.

Syntax

apm cache show

apm cache clear

Syntax Description

Parameter	Description
<i>show</i>	It means to display the information related to VigorAP registered Vigor3912.
<i>clear</i>	It means to remove the information related to VigorAP registered Vigor3912.

Example

```

> apm cache show
MAC           Name                Auth
-----
00507FF17EE5 VigorAP903          admin:admin
001DAA04F060 VigorAP1000C        admin:admin
00507FF17EE8 VigorAP903          admin:admin
>

```

Telnet Command: apm lbcfg

This command allows to set parameters related to AP management control.

Syntax

apm lbcfg set <value>

apm lbcfg show

Syntax Description

Parameter	Description
<i>set</i>	It means to set the load balance configuration file for APM.
<i>Show</i>	It shows the configuration value.
<value>	<p>You need to type 10 numbers in this field. Each number represents different setting value.</p> <p>[1] - The first number means the load balance function. Type 1 - enable load balance, 0 - disable load balance.</p> <p>[2] - The second number means the station limit function. Type 1 -enable station limit, 0 - disable station limit.</p> <p>[3] - The third number means the traffic limit function. Type 1 - enable traffic limit, 0 - disable traffic limit.</p> <p>[4] - The forth number means the limit num of station. Available range is 3-64.</p> <p>[5] - The fifth number means the upload limit function. Type 1 - enable upload limit, 0 - disable upload limit.</p> <p>[6] - The sixth number means the download limit function. Type 1 - enable download limit, 0 - disable download limit.</p> <p>[7] - The seventh number means disassociation by idle time. Type 1 - enable disassociation, 0 - disable disassociation.</p> <p>[8] - The eighth number means to enable or disable disassociation by signal strength. Type 1 - enable disassociation, 0 - disable disassociation.</p> <p>[9] - The ninth number means to determine the unit of traffic limit (for upload) 1 - Mbps 0 - kbps</p> <p>[10] - The tenth number means to determine the unit of traffic limit (for download) 1 - Mbps 0 - kbps</p> <p>[11] - This number means to set RSSI threshold (-200 to -50 dbm).</p>

Example

```
> apm lbcfg show
apm LoadBalance Config :
1. Enable LoadBalance : 0
2. Enable station limit : 0
3. Enable traffic limit : 0
```

```

4. limit Number : 64
5. Upload limit : 0
6. Download limit : 0
7. Enable disassociation by idle time : 0
8. Enable disassociation by Signal strength : 0
9. Traffic limit unit (upload) : 0
10.Traffic limit unit (download) : 0
11.RSSI threshold : 0
flag : 0
> apm lbcfg set 1 1 1 3 1 1 1 1 1 1 -100
> apm lbcfg show
apm LoadBalance Config :
1. Enable LoadBalance : 1
2. Enable station limit : 1
3. Enable traffic limit : 1
4. Limit Number : 3
5. Upload limit : 1
6. Download limit : 1
7. Enable disassociation by idle time : 1
8. Enable disassociation by Signal strength : 1
9. Traffic limit unit (upload) : 1
10.Traffic limit unit (download) : 1
11.RSSI threshold : -100
flag : 63
>

```

Telnet Command: apm apsyslog

This command is used to display the AP syslog data coming form VigorAP.

Syntax

apm apsyslog <AP_Index>

Syntax Description

Parameter	Description
AP_Index	Specify the index number which represents VigorAP.

Example

```

> apm apsyslog 1
8d 02:46:09 syslog: [APM] Send Rogue AP Detection data.
8d 02:53:04 syslog: [APM] Run AP Detection / Discovery.
8d 02:56:09 syslog: [APM] Send Rogue AP Detection data.
8d 03:00:42 kernel: 60:fa:cd:55:f5:ea had disassociated.
8d 03:03:12 syslog: [APM] Run AP Detection / Discovery.
8d 03:06:09 syslog: [APM] Send Rogue AP Detection data.
8d 03:13:21 syslog: [APM] Run AP Detection / Discovery.
8d 03:16:10 syslog: [APM] Send Rogue AP Detection data.
8d 03:16:41 kernel: 60:fa:cd:55:f5:ea had associated successfully
8d 03:16:55 kernel: 60:fa:cd:55:f5:ea had disassociated.

```

Telnet Command: apm syslog

This command is used to display related syslog data from central AP management.

Syntax

apm syslog

Example

```
> apm syslog
"2021-01-04 04:12:59", "[APM] [VigorAP903_F17EE5] GET temper/traffic
data failed "
"2021-01-04 04:13:21", "[APM] [VigorAP903_F17EE5] has no response "
"2021-01-04 04:13:21", "[APM] [VigorAP903_F17EE5] GET temper/traffic
data failed "
"2021-01-04 04:13:43", "[APM] [VigorAP903_F17EE5] has no response "
"2021-01-04 04:13:43", "[APM] [VigorAP903_F17EE5] GET temper/traffic
data failed "
>
```

Telnet Command: apm stanum

This command is used to display the total number of the wireless clients, no matter what mode of wireless connection (2.4G WLAN or 5G WLAN) used by wireless clients to access into Internet through VigorAP.

Syntax

apm stanum <AP_Index>

Syntax Description

Parameter	Description
AP_Index	Specify the index number which represents VigorAP.

Example

```
> apm stanum

% Show the APM AP Station Number data.
% apm stanum AP_Index.
%   ex : apm stanum 1
%       Idx Nearby(2.4/5G) Conn(2.4/5G)
%       1   2   5           0   0
%       2   2   5           1   0
%       3   2   5           1   0
```

Telnet Command: ha set

This command can be used to configure HA settings for Vigor routers.

Syntax

ha set [-<command> <parameter>] ...]

Syntax Description

Parameter	Description
[<command> <parameter>/[...]]	The available commands with parameters are listed below. [...] means that you can type in several parameters in one line.
-e <1/0>	1: Enable the function of High Availability (HA). 0: Disable the function of High Availability (HA).
-l <1/0>	1: Enable the function of recording the operation record of HA in Syslog. 0: Disable the function of recording the operation record of HA in Syslog.
-M <1/0>	Specify the Redundancy Method for HA. 1: Active-Standby 0: Hot-Standby
-v <1-255>	Specify the group ID (VHID) 1- 255: Setting range.
-R	Set HA settings to Factory Default.
-p <1-30>	Specify the Priority ID. 1-30: Setting range.
-k <key>	Specify the Authentication Key. Key: Max. 31 Characters.
-u <1/0>	Enable or disable the function of Update DDNS. 1: Enable. When a router changes HA status to primary, it will update DDNS automatically. 0: Disable.
-m <interface>	Specify the management interface. Interface: LAN1 ~ LAN8, DMZ.
-s	It means to get the newest status of other router (except the local router).
-y	It means sync local config to other router. Primary can executes this command. Secondary can not execute this commad.
-c <1/0>	Enable or disable the function of Config Sync. 1: Enable. 0: Disable.
-C <config type> <1/0>	Exclude the following settings from config sync. Config type: 1 (WAN settings)
-I -[M H D] <interval>	Set the Config Sync Interval for HA. Minimum interval is 15 minutes. -M: Minute. Setting range is 0/15/30/45. (e.g., ha set -I -M 30) -H: Hour. Setting range is from 0 to 23. (e.g., ha set -I -H 12) -D: Day. Setting range is from 0 to 30. (e.g., ha set -I -D 15)
-h <Subnet> [<Virtual IP>]	Enable and set virtual IP to the subnet. Subnet: LAN1 to LAN8, DMZ. Virtual IP: The type format shall be "xxx.xxx.xxx.xxx". (e.g, 192.168.1.0) For example, to enable a virtual IP to the sunet, simply type: ha set -h LAN1 192.168.1.5
-d -<4/6><Subnet>	Disable a virtual IP to the subnet. 4: IPv4; 6: IPv6. Subnet: LAN1 to LAN100. For example, to disable a virtual IP to the subnet, just type: ha set -h LAN1
-o <1/0>	Run DARP protocol on IPv4 or IPv6. 0: IPv4 1: IPv6

Example

```
> ha set -h -4 LAN1 192.168.1.1
```

```

% Enable IPv4 Virtual IP on LAN1

% Virtual IP can not be same as router IP (192.168.1.1)!!!

>

```

Telnet Command: ha show

This command can be used to show the *settings information* about config sync and general setup.

Syntax

ha show -c

ha show -g

Syntax Description

Parameter	Description
-c	Show the settings of config sync.
-g	Show the settings of general setup.

Example

```

> ha show -g
% High Availability      : Disable
% Redundancy Method    : Active-Standby
% Group ID              : 1
% Priority ID           : 10
% Update DDNS          : Disable
% Protocol              : IPv4
% Management Interface : LAN1
% Authentication Key   : draytek
% Syslog                : OFF
%
% [ Index | Enable | Virtual IP ]
% LAN1   -   192.168.100.2
% LAN2   -   192.168.200.2
% LAN3   -   192.168.3.2
% LAN4   -   192.168.4.2
% LAN5   -   192.168.5.2
% LAN6   -   192.168.6.2
% LAN7   -   192.168.7.2
% LAN8   -   192.168.8.2
% LAN9   -   192.168.9.2
% LAN10  -   192.168.10.2
% LAN11  -   192.168.11.2
...
...
>

```

Telnet Command: ha status

This command is used to display *HA status information*.

Syntax

ha status -a <Detail Level>

ha status -m <Detail Level>

Syntax Description

Parameter	Description
<i>-a</i>	Show the status for all of the routers in HA group.
<i>-m</i>	Show the status of local router only.
<i>Detail Level</i>	0: Basic information. 1: Basic information with more data (e.g. , firmware version, model, HTTPs port. MAC address and etc). 2: Basic information with some HA settings.

Example

```

> ha status -m 2
% [Local Router] Marketing3912
% IP : 192.168.100.1 (FE80::21D:AFF:FE4B:3E80)
% Status : !
% High Availability : ! Disable
% Redundancy Method : Active-Standby
% Group ID : 1
% Priority ID : 10
% Update DDNS : Disable
% Protocol : IPv4
% Management Interface : LAN1
% Authentication Key : draytek
% Virtual IP: (Max. 51 Virtual IPs)
% ! OFF
% Virtual IPv6: (Max. 51 Virtual IPv6s)
% ON LAN1 FE80::200:5EFF:FE00:101
% ON LAN2 FE80::200:5EFF:FE00:101
% ON LAN3 FE80::200:5EFF:FE00:101
% ON LAN4 FE80::200:5EFF:FE00:101
% ON LAN5 FE80::200:5EFF:FE00:101
% ON LAN6 FE80::200:5EFF:FE00:101
% ON LAN7 FE80::200:5EFF:FE00:101
% ON LAN8 FE80::200:5EFF:FE00:101
% ON LAN9 FE80::200:5EFF:FE00:101
% ON LAN10 FE80::200:5EFF:FE00:101
% ON LAN11 FE80::200:5EFF:FE00:101
% ON LAN12 FE80::200:5EFF:FE00:101
% ON LAN13 FE80::200:5EFF:FE00:101
% ON LAN14 FE80::200:5EFF:FE00:101
% ON LAN15 FE80::200:5EFF:FE00:101
% ON LAN16 FE80::200:5EFF:FE00:101
% ON LAN17 FE80::200:5EFF:FE00:101
% ON LAN18 FE80::200:5EFF:FE00:101
% ON LAN19 FE80::200:5EFF:FE00:101
% ON LAN20 FE80::200:5EFF:FE00:101
% ON LAN21 FE80::200:5EFF:FE00:101
%%
>

```

Telnet Command: `swm show`

This command is used to display general setting of of VigorSwitch which connecting to Vigor router in LAN.

Syntax

`swm show <LAN_port>`

Syntax Description

Parameter	Description
<code>LAN_port</code>	Specify the LAN port number (1 to 12).

Example

```
>swm show 3

** If you want to display SWM debug log : "swm show debug log"
** Enable/Disable SWM console debug log : "swm show console log en/dis"
** Enable/Disable SWM syslog debug log : "swm show syslog log en/dis"

** If you connected a VigorSwitch but does not display here.
** Please check the LLDP is enabled and VLAN ID is matched on VigorSwitch.

*****
LAN Port  Level    UP - Link Model  UP - MAC    UP - Port Model Name    MA
C          IP Address    Down - Port
-----
3          1          Router          8          G2280          0
01DAA0CCD08 192.168.1.10
-----

*****

Internal VLAN is [Disable]

G2280          Level 1          MAC 00:1D:AA:0C:CD:08
-----

VLAN Port Table:
PVID   Port Num          Egress  Frame Type  Port Type    Ingress Flt
-----
1      1-28              hybric   all         unaware      enabled
-----

VLAN Table:
VID    VLAN Name        Port Num          Forbidden Port Num
-----
1     vlan1            1-28              none
*****

(Total 1 Switch)
```

Telnet Command: swm get

This command is used to get configuration information of VigorSwitch which connecting to Vigor router in LAN. Before using such command, make sure VigorSwitch has been managed

under Vigor router (refer to Telnet Command: swm profile for adding a VigorSwitch device onto Vigor router).

Syntax

swm get <MAC>

Syntax Description

Parameter	Description
MAC	Enter the MAC address (e.g., 001DAA0CCD08) of the VigorSwitch.

Example

```
> swm get 001DAA0CCD08
Start get cfg from 001daa0ccd08 external switch

Please wait a few seconds...

Result: [OK].
>
```

Telnet Command: swm post

This command is used to transfer switch configuration to VigorSwitch which connecting to Vigor router in LAN.

Syntax

swm post <MAC>

Syntax Description

Parameter	Description
MAC	Enter the MAC address (e.g., 001DAA0CCD08) of the VigorSwitch.

Example

```
> swm post 001DAA0CCD08
Start post cfg to 001daa0ccd08 external switch with current settings.
Please wait a few seconds...
Result: [OK].
>
```

Telnet Command: swm enable / disable

This command is used to enable / disable the external device.

Example

```
> swm enable ?
Enable Switch Mangement:    swm enable

> swm enable
External Device Discovery is not enable.
We will enable both.
```

Telnet Command: swm group

This command is used to add, edit or display the switch management group.

Syntax

```
swm group set <IDX> <NAME> <1> <PASSWD>
```

```
swm group set <IDX> <NAME> <0>
```

```
swm group show
```

```
swm group add <IDX> <MAC>
```

```
swm group delete <IDX> <MAC>
```

Syntax Description

Parameter	Description
<i>set</i> <IDX> <NAME> <1> <PASSWD>	It means to set group name and group password. <IDX>: Enter the index number (1 to 10) of the group. <NAME>: Enter the name of the group. <1>: It means the password flag. <PASSWD>: Enter a string as the password.
<i>show</i>	It means to display switch group status.
<i>add</i> <IDX> <MAC>	It means to add a switch into the group as a member switch. <IDX>: Enter the index number (1 to 10) of the group. <MAC>: Enter the MAC address of VigorSwitch.
<i>delete</i> <IDX> <MAC>	It means to delete a switch from the group. <IDX>: Enter the index number (1 to 10) of the group. <MAC>: Enter the MAC address of VigorSwitch.

Example

```
> swm group set 10 pease 1 jpsword
> swm group show
Index   Group Name      Passwd Flag      Member Switch
-----
1       pease           1                 G2280(192.168.1.10),
2
3       0
4       0
5       0
6       0
7       0
8       0
9       0
10      pease           1
Name                IP Address        MAC
-----
G2280                192.168.1.10     001daa0ccd08
```

Telnet Command: swm profile

This command is used to add, edit or display the switch management profile.

Syntax

swm profile *add/delete* <MAC>

swm profile *show*

swm profile *enable_all/disable_all* <MAC>

Syntax Description

Parameter	Description
<i>add/delete</i> <MAC>	It means to add or delete a member switch from the profile. <MAC>: Enter the MAC address of the switch.
<i>show</i>	It means to display switch profile.
<i>enable_all/disable_all</i> <MAC>	It means to enable or disable all LAN ports of the specified switch managed by Vigor router. <MAC>: Enter the MAC address of the member switch.

Example

```
> swm profile show
Name                IP Address          MAC                  Model   Group
-----
G2280                192.168.1.10       001daa0ccd08       G2280   peace,peace,
IP Address          MAC                  Model
-----
>
```

Telnet Command: swm detail

This command is used to configure general settings (e.g., switch name, password) and port settings for VigorSwitch.

Syntax

swm detail *comment* <MAC> <COMMENT>

swm detail *name* <MAC> <NAME>

swm detail *passwd* <MAC> <PASSWD>

swm detail *config* <MAC> <config>

swm detail *show*

swm detail *port show* <MAC>

swm detail *port* <MAC> <PORT> <FLAG> <SCHED1> <SCHED2> <DESCRIPTION>

swm detail *rate* <MAC> <PORT> <i/e> <e/d>

swm detail *rate* <MAC> <PORT> <i/e> <ratelimit>

Syntax Description

Parameter	Description
<i>comment</i> <MAC> <COMMENT>	It means to set a comment for VigorSwitch. <MAC>: Enter the MAC address of the VigorSwitch to be modified. <COMMENT>: Add an additional explanation for the switch.
<i>name</i> <MAC> <NAME>	It means to set a name for VigorSwitch. <MAC>: Enter the MAC address of the VigorSwitch to be modified. <NAME>: Enter the name of VigorSwitch.

<i>passwd <MAC> <PASSWD></i>	It means to set a login password for VigorSwitch. <MAC>: Enter the MAC address of the VigorSwitch to be modified. <NAME>: Enter the login password of VigorSwitch.
<i>config <MAC> <config></i>	It means to apply the configuration of VigorSwitch B to other VigorSwitch A. <MAC>: Enter the MAC address of the VigorSwitch A to be modified. <config>: Enter the index number of the profile set in VigorSwitch B.
<i>show</i>	It means to display comment, MAC and connection status of the switch.
<i>port show <MAC></i>	It means to display a list of LAN ports of the VigorSwitch. <MAC>: Enter the MAC address of the VigorSwitch to be modified.
<i>port <MAC> <PORT> <FLAG> <SCHED1> <SCHED2> <DESCRIPTION></i>	It means to set a description and schedule profile for each port of VigorSwitch. <MAC>: Enter the MAC address of the VigorSwitch to be modified. <PORT>: Enter the index number (e.g., 1 to 28) of the VigorSwitch LAN port. The number of LAN ports will vary according to the Switch to be modified. <SCHED1> <SCHED2>: Determine and type two index numbers of the schedule profiles you want. <DESCRIPTION>: Enter a description for each port of VigorSwitch.
<i>rate <MAC> <PORT> <i/e> <e/d></i>	It means to enable / disable the rate limit for each port of VigorSwitch. <MAC>: Enter the MAC address of the VigorSwitch to be modified. <PORT>: Enter the index number (e.g., 1 to 28) of the VigorSwitch LAN port. The number of LAN ports will vary according to the Switch to be modified. <i/e>: "i" means Ingress Rate; "e" means Egress Rate. <e/d> "e" means enable; "d" means disable the setting.
<i>rate <MAC> <PORT> <i/e> <ratelimit></i>	It means to modify the rate limit for each port of VigorSwitch. <MAC>: Enter the MAC address of the VigorSwitch to be modified. <PORT>: Enter the index number (e.g., 1 to 28) of the VigorSwitch LAN port. The number of LAN ports will vary according to the Switch to be modified. <i/e>: "i" means Ingress Rate; "e" means Egress Rate. <ratelimit>: Enter a value.

Example

```

> swm detail rate 001DAA0CCD08 1 i 5000
> swm detail comment 001DAA0CCD08 availablefor2floor
> swm detail rate 001DAA0CCD08 1 i 5000
> swm detail show
Idx Name          MAC          Comment          Config
Status
-----
1   G2280        001daa0ccd08          1   None
Connect

> swm detail comment 001DAA0CCD08 availablefor2floor
> swm detail show
Idx Name          MAC          Comment          Config
Status
-----

```

```

1 G2280 001daa0ccd08 availablefor2floor 1 None
Connect

>

```

Telnet Command: swm maintain

This command is used to reboot or reset the switch to factory default setting.

Syntax

`swm maintain reboot <MAC>`

`swm maintain reset <MAC>`

`swm maintain show`

Syntax Description

Parameter	Description
<code><i>reboot</i> <MAC></code>	It means to reboot VigorSwitch with current settings. <MAC>: Enter the MAC address of the VigorSwitch to be modified.
<code><i>reset</i> <MAC></code>	It means to reset VigorSwitch with factory default settings. <MAC>: Enter the MAC address of the VigorSwitch to be modified.
<code><i>show</i></code>	It means to display comment, MAC and connection status of the switch.

Example

```

> swm maintain show
Name          IP Address      MAC              Model
-----
G2280         192.168.1.10   001daa0ccd08   G2280
> swm maintain reset 001daa0ccd08
Preparing to reset.
Please wait for few minutes and do not turn off power.

```

Telnet Command: swm search

This command is used to search Vigor Switch by MAC / IP address / specific description and display information.

Syntax

`swm search mac <MAC>`

`swm search ip <IP>`

`swm search description <Input>`

Syntax Description

Parameter	Description
<code><i>mac</i> <MAC></code>	<MAC>: Enter the MAC address of the VigorSwitch to be searched.
<code><i>ip</i> <IP></code>	<IP>: Enter the IP address of the VigorSwitch to be searched.
<code><i>description</i> <input></code>	<input>: Enter the model name of the VigorSwitch to be searched.

Example

```

> swm search mac 001daa0ccd08
Type      IP Address      MAC              Description / Name      Lan Port
UpLink Port  Level  Port
-----
Switch 192.168.1.10  00:1D:AA:0C:CD:08 G2280                P3
Vigor Router  0    3
>

```

Telnet Command: swm db

This command is used to enable/disable database to record switch management information.

Syntax

- swm db *ctl en/dis*
- swm db *ctl show*
- swm db *alert notify <N/S>*
- swm db *alert action <S/B>*
- swm db *alert sms <IDX>*
- swm db *alert mail <IDX>*

Syntax Description

Parameter	Description
<i>ctl en/dis</i>	It means to enable or disable the function of displaying database control status. en: Enable the function. dis: Disable the function.
<i>ctl show</i>	It means to show the the database control status.
<i>alert notify <N/S></i>	It means to set alert notification (N or S) condition when storage exceeded. N:Don't send notification. S: Send notification.
<i>alert action <S/B></i>	It means to set the alert action (S or B) condition when storage exceeded. S: Stop recording urser information. B: Backup and clean up all user info, and start a new record.
<i>alert sms <IDX></i>	It means to set SMS object which will get the information from Vigor router if something wrong with VigorSwitch. <IDX>: Enter the index number of the mail object.
<i>alert mail <IDX></i>	It means to set mail object which will get the information from Vigor router if something wrong with VigorSwitch. <IDX>: Enter the index number of the mail object.

Example

```

> swm db ctl en
Enable database to recoard SWM information.
>

```

Telnet Command: swm alert

This command is used to define the name of alert, level of alert (in color), and determine to record the data in the database, or send a notification message to the user based on the level.

Syntax

```
swm alert enable/disable
swm alert show
swm alert en/dis <Idx>
swm alert set <Idx> log <e/d>
swm alert set <Idx> name <name>
swm alert set <Idx> color <O/R/N>
swm alert set <Idx> notif <e/d>
swm alert set <Idx> obj <object idx> <object value>
swm alert display
swm alert en/dis <sw/port> <mac>
swm alert sw show <mac>
swm alert set sw <mac> <incident idx> <level idx>
swm alert port show <mac>
swm alert set port <mac> <port num><incident idx> <level idx>
```

Syntax Description

Parameter	Description
<i>enable/disable</i>	It means to enable/disable Alert mechanism. enable: Enable the mechanism. disable: Disable the mechanism.
<i>show</i>	It means to display a list of all alert setup.
<i>en/dis <Idx></i>	It means to enable / disable the Alert Action settings. en: Enable the settings. dis: Disabel the settings. <Idx>: Enter the index number (1 to 8) of the alert action item.
<i>set <Idx> log <e/d></i>	It means to enable / disable the function of creating log of alert. e: Enable the settings. d: Disabel the settings. <Idx>: Enter the index number (1 to 8) of the alert action item. Note that No Log for index 1; and log for index 2 is enabled in default.
<i>set <Idx> name <name></i>	It means to set level name of each alert. <Idx>: Enter the index number (1 to 8) of the alert action item. <name>: Enter a short description of the alert.
<i>set <Idx> color <O/R/N></i>	It means to define the color for each level of alert. The color of index 1 is No color and unable to be changed. <Idx>: Enter the index number (2 to 8) of the alert action item. <O/R/N>: "O" means orange; "R" means red; "N" means no color.
<i>set <Idx> notif <e/d></i>	It means to enable or disable the function of sending notification to specified phone number via SMS. <Idx>: Enter the index number (3 to 8) of the alert action item. e: Enable the settings. d: Disabel the settings.
<i>set <idx> obj <object idx> <object value></i>	It means to specify SMS/Email service object(s) for the alert item. Each alert can be set with up to four objects. <Idx>: Enter the index number (3 to 8) of the alert action item. <object idx>: Enter the queue number (1 to 4) for specifying an object profile. <object value>: Enter the index number (1 to 10) of the SMS/Email service object profile.

<i>display</i>	It means to display all switches with port alert state.
<i>en/dis <sw/port> <mac></i>	It means to enable or disable the Switch Alert /Port Alert action. en: Enable the function. dis: Disable the function. <sw/port>: "sw" means Switch Alert; "port" means Port Alert. <mac>: Enter the MAC address of the VigorSwitch.
<i>sw show <mac></i>	It means to display incident and alert type of the VigorSwitch. <mac>: Enter the MAC address of the VigorSwitch.
<i>set sw <mac> <incident idx> <level idx></i>	It means to set incident and alert type of the VigorSwitch. <mac>: Enter the MAC address of the VigorSwitch. <incident idx>: Range 1 - 4 <level idx>: 1 - 8
<i>port show <mac></i>	Display Port Incident Alert <mac>: Enter the MAC address of the VigorSwitch.
<i>set port <mac> <port num> <incident idx> <level idx></i>	Set Port Incident Alert <mac>: Enter the MAC address (e.g., 001DAA0EB0DB) of the VigorSwitch. <port num>: Range 1 - 28 <incident idx>: Range 1 - 4 <level idx>: 1 - 8

Example

```

> swm alert set 2 color N
> swm alert show

```

Idx	En/Dis	Level	Color	Create	Log	Send Notification(1-4)
1	En	No Alert	No Color	Disable	Disable	0 , 0 , 0 , 0
2	En	Minor Alert	No Color	Enable	Disable	0 , 0 , 0 , 0
3	En	Moderate Alert	Orange	Enable	Disable	0 , 0 , 0 , 0
4	En	Major Alert	Red	Enable	Disable	0 , 0 , 0 , 0
5	Dis		No Color	Disable	Disable	0 , 0 , 0 , 0
6	Dis		No Color	Disable	Disable	0 , 0 , 0 , 0
7	Dis		No Color	Disable	Disable	0 , 0 , 0 , 0
8	Dis		No Color	Disable	Disable	0 , 0 , 0 , 0

```

>
>

```

Telnet Command: swm log

This command is used to display switch management log.

Syntax

swm log show filter

swm log show day

swm log show week

swm log set level <idx> on/off

swm log set type <idx> on/off

swm log set switch <mac> on/off

Syntax Description

Parameter	Description
<i>show filter</i>	It means to display the log filter setup.
<i>show day</i>	It means to display the quantity of day log.
<i>show week</i>	It means to display the quantity of week log.
<i>set level <idx> on/off</i>	It means to turn on or turn off the alert level. <idx>: 1 to 8. on/off: Set the status (on or off) of the alert.
<i>set type <idx> on/off</i>	It means to turn on or turn off the port alert/switch alert. <idx>: 1 to 2. "1" means Port Alert; "2" means Switch Alert. on/off: Set the status (on or off) of the alert.
<i>set switch <mac> on/off</i>	It means to set Switch Filter: <mac>: Enter the MAC address of the VigorSwitch. on/off: Set the status (on or off) of the alert.

Example

```

> swm log show filter
Index Status Level           En/Dis
-----
1    off    No Alert           En
2    off    Minor Alert        En
3    off    Moderate Alert     En
4    off    Major Alert        En
5    off
6    off
7    off
8    off
           Dis

Index Status Type
-----
1    on     Port Alert
2    off    Switch Alert

Index Status Switch Name     Model  Mac Address
-----
1    on     G2280           G2280  001daa0ccd08
> swm log set level 8 on
>

```

Telnet Command: swm snmp

This command is used to display switch information via SNMP query.

Syntax

```

swm snmp sys <MAC>
swm snmp iftbl <MAC> <port_num>
swm snmp poe <MAC>
swm snmp trpcom show <MAC>
swm snmp trpcom set <MAC> <name>

```

Syntax Description

Parameter	Description
<i>sys</i> <MAC>	It means to show the system information. <MAC>: Enter the MAC address of the VigorSwitch.
<i>iftbl</i> <MAC> <port_num>	It means to show port interface information. <MAC>: Enter the MAC address of the VigorSwitch. <port_num>: Enter the index number (e.g., 1 to 28) of the VigorSwitch LAN port. The number of LAN ports will vary according to the Switch to be modified.
<i>poe</i> <MAC>	It means to show snmp POE interface information. <MAC>: Enter the MAC address of the VigorSwitch.
<i>trpcom show</i> <MAC>	It means to show Trap Community. <MAC>: Enter the MAC address of the VigorSwitch.
<i>trpcom set</i> <MAC> <name>	It means to set Trap Community. <MAC>: Enter the MAC address of the VigorSwitch. <name>: Enter a string as tramp community.

Example

```
> swm snmp sys 001daa0ccd08
sysDescr:
sysObjectID:
sysUpTime:0 hr 0 m 0 s
sysContact:
sysName:
sysLocation:
sysServices:0
ifNumber:0
> swm snmp trpcom show 001daa0ccd08
Trap Community:public
>
```

Telnet Command: linux

Before using the Linux services, you have to specify the basic settings, including IP address, subnet mask and SSH port value for Linux applications.

Syntax

linux setlinuxip <-i IP> <-c CIDR> <-g Gateway> <v VLANx> <-p password>

linux status

linux clean - a / -b / -d / -o / -w

linux service <telnet/ssh> <enable/disable/status/setport>

linux syslog <enable/disable/status>

linux ring <set/send/clean/test/debug>

Syntax Description

Parameter	Description
<i>setlinuxip</i> <-i IP> <-c CIDR> <-g Gateway> <v VLANx> <-p password>	It means to set Linux IP and gateway. IP - necessary. Linux IP set to LAN subnet IP. CIDR - optional (Classless Inter-Domain Routing). Enter a number between 1-32. The default is 24. Gateway - optional. Usually it will be set to router's LAN IP. The

	<p>default is 0.0.0.0.</p> <p>VLANx- optional. For tagged subnet, enter a number between 0-99 to set VLAN group. The default is 0 (VLAN0).</p> <p>password - Add -p "admin's password" for 1st time setting and reboot to take effect.</p>
<i>status</i>	Display current status of linux application.
<i>clean -a / -b / -d / -o / -w</i>	<p>Clean the linux service information by using the following command.</p> <p>-a - clean local app partion (甚麼是 app partion? 不懂><)</p> <p>-b - clean backedup firmware and configuration (這是指打了此指令後，路由器會先刪除備份的設定資料，然後重新用預設值啟動嗎?)</p> <p>-d - clean local data partion (甚麼是 data partion? 不懂><)</p> <p>-o - Select this option to reboot Vigor system with current configuration but remove the application(s) related to Linux application from the Vigor router.</p> <p>-w - Wipe out all data of linux service and reboot the router.</p>
<i>service <telnet/ssh> <enable/disable/status/set port></i>	<p>Enable/disable the security service based on the protocol telnet/SSH for Linux applications.</p> <p><telnet/ssh> - Specify the protocol.</p> <p><enable/disable/status/setport> - Enable/ disable the service.</p> <p><status> - Display the current setting status for the service based on the protocol of Telnet/SSH.</p> <p><setport> - Set the Telnet/SSH port number (1 to 65535).</p>
<i>syslog <enable/disable/status></i>	<enable/disable/status> - Enable/disable the function of saving all syslog about Linux service to internal flash.
<i>ring <set/send/clean/test/debug ></i>	<p>This command is for temporary using, until web ui is done (指令行有出現上面的一句說明，不知道是指甚麼意思，可以解說一下嗎?)</p>

Example

```

> setlinuxip -i 192.168.2.100 -c 24 -g 192.168.2.1 -v 2

> linux status
Status = 0
Linux IP is empty.
Gateway IP is empty.
VLAN is VLAN0
>

```

Telnet Command: service

This command is used to display information about MyVigor service. In addition, it allows to transfer MyVigor service from the original account to other account.

Syntax

service -s

service -r

service -l <account> <password>

service -i <new_owner> <new_owner_email>

service -t <yes>/<no>

service -c

Syntax Description

Parameter	Description
-s	Display the service status.
-r	Refresh the service status
-l <account><password>	Login to MyVigor server. Enter the account and password registered to MyVigor server account - Enter the name of the account. Password - Enter the password of the account.
-i <new_owner><new_owner_email>	Enter the name and the e-mail address of the new owner for service transfer. New_owner - Enter the account name of the new owner. New_owner_email - Enter the e-mail address of the new owner.
-t <yes>/<no>	Transfer this Vigor device to a new owner.
-c	Clear current owner's account information.

Example

```
> service
> service -l carrieni ttt0016ttt5
Login Account:carrieni, Pw:ttt0016ttt5
Login Success! Please check Service Status again!
> service -s
Show service status.
Now state is [SS_STATE_REG_ACC_VALID]
Service Status:
Model Name   : Vigor3912 Series
Serial Number: 2019053108580701
MAC Address  : 00:1D:AA:73:4A:78
Owner Account: carrieni
E-mail       : ca*****i@draytek.com

Device service support status:
Service WCF, ID = [1]
  Service Provider [Cyren]
  Licese Start_date [2019-09-26]
  Licese Exp_date [2019-10-26]

Service APPE, ID=[4]
  Service Provider [Not Activated]
  Licese Start_date []
  Licese Exp_date []

Service DDNS, ID=[6]
  Service Provider [Not Activated]
  Licese Start_date []
  Licese Exp_date []
>
```